

UNIVERSITÀ DELLA CALABRIA



UNIVERSITÀ DELLA CALABRIA

Dipartimento di Fisica

**Dottorato di Ricerca in**

Scienze e Tecnologie Fisiche, Chimiche e dei Materiali  
Convenzione Università della Calabria-Consiglio Nazionale delle Ricerche

**CICLO**

XXIX

**TITOLO TESI**

DEVELOPMENT OF BIO-HYBRID MULTIFUNCTIONAL POLYMERIC-BASED  
MEMBRANES FOR BIO-RECOGNITION AND BIO-SEPARATION

**Settore Scientifico Disciplinare CHIM/03 Chimica Generale e Inorganica**

**Coordinatore:** Ch.mo Prof. Vincenzo Carbone  
*Vincenzo Carbone*

**Supervisore:** Dott.ssa Lidietta Giorno  
*Lidietta Giorno*

**Tutor:** Dott.ssa Teresa Poerio  
*Teresa Poerio*

**Dottoranda:** Dott.ssa Francesca Militano

*Francesca Militano*

## ACKNOWLEDGEMENTS

*Firstly, I desire to express my thankfulness to my supervisor Dr. Lidiatta Giorno for her support, motivation, and immense knowledge in the field of membrane science. Thanks for encouraging my research and for allowing me to grow as a research scientist. I would also like to thank Dr. Teresa Poerio who helped me and supported me throughout these years. Thanks also to Dr. Rosalinda Mazzei for her support. A special thanks to my colleagues and friends of the “third floor”. Finally, I would like to mention my family, and in particular Mattia who always encourage and support me.*

---

**Index**

<b>List of figures</b>	6
<b>List of tables</b>	10
<b>Sommario</b>	11
Contenuti della tesi	14
<b>Summary</b>	15
Dissertation outlines	17
<b>Chapter 1</b>	18
<b>Introduction to bio-functionalized membranes</b>	
1.1 Membranes and membrane processes	19
1.2 Bio-functional membranes basic concepts	20
1.3 Applications of bio-functionalized membranes	21
1.3.1 Biocatalysis: biocatalytic membrane reactors	21
1.3.2 Separation: affinity membranes	22
1.3.3 Analysis: biosensors	23
1.4 Preparation of bio-functional polymeric membranes	23
1.4.1 Membrane surface functionalization/activation	24
1.4.1.1 Coating	25
1.4.1.2 Wet chemical	26
1.4.1.3 Self-assembly	29
1.4.1.4 Plasma treatment	30
1.4.1.5 UV irradiation	30
1.4.1.6 Surface Graft Polymerization	30
1.4.2 Biomolecules immobilization	31
1.5 Factors affecting biomolecules immobilization	34
1.5.1 Surface properties	35
1.5.2 Protein properties	36
1.5.3 Medium	37

---

1.6 Concluding remarks and advancements	38
<b>Chapter 2</b>	<b>48</b>
<b>Membranes for biosensors development</b>	
2.1 Biosensors basic concepts	49
2.2 Membranes for biosensing	52
2.2.1 Membrane properties and functions	53
2.2.2 Membrane materials	54
2.2.3 Membranes integration with miniaturized systems	57
2.3 Orientation of the bioreceptor	58
2.4 Transduction mechanisms and systems	60
2.4.1 Electrochemical detection	61
2.4.2 Optical detection	65
2.5 Applications of membranes in biosensors	66
2.6 General considerations and advancements	69
<b>Chapter 3</b>	<b>79</b>
<b>Development of bio-functionalized membranes: study of the relationship between proteins properties and membrane surface coverage</b>	
3.1 Materials and chemicals	81
3.2 Experimental methods	82
3.2.1 Membrane surface functionalization strategies	82
3.2.2 Functionalized membranes characterization	84
3.2.2.1 Infrared analysis	84
3.2.2.2 Ninhydrin test	84
3.2.2.3 Water permeability measurement	85
3.2.3 Biomolecules characterization in solution	85
3.2.3.1 Dynamic light scattering	86
3.2.3.2 Native gel Electrophoresis	86
3.2.4 Biomolecules immobilization on functionalized membrane surface	87
3.2.4.1 Reduction step optimization	87
3.2.4.2 Effect of proteins concentration and contact time	87
3.2.4.3 Determination of the amount of immobilized biomolecules	88
3.2.5 Membrane morphology	88

---

---

3.2.6 Performances of free and immobilized proteins	88
3.3 Results and discussion	90
3.3.1 Functionalized membranes characterization	90
3.3.2 Biomolecules characterization	94
3.3.3 Biomolecules immobilization	98
3.3.3.1 Adsorption tests	98
3.3.3.2 Reduction step optimization	99
3.3.3.3 Biomolecules immobilization trend	100
3.3.4 Kinetics of immobilization	105
3.3.5 Bio-functionalized membranes surface morphology	107
3.3.6 Performances of free and immobilized proteins	111
3.4 Conclusions	114
<b>Chapter 4</b>	<b>119</b>
<b>Development of immuno-selective membranes for targeted interleukin-6 antigen capture, concentration and detection</b>	
4.1 Materials and chemicals	121
4.2 Experimental procedures	122
4.2.1 Protein G immobilization	122
4.2.1.1 Binding capacity of immobilized protein G	122
4.2.1.2 Analysis of the equilibrium adsorption data	123
4.2.2 Strategies for anti IL-6 antibody bio-affinity immobilization	124
4.2.2.1 Quenching step optimization	124
4.2.3 Evaluation of IL-6 capturing by the immuno-affinity membranes	126
4.2.3.1 ELISA tests	126
4.2.3.2 Confocal analysis	127
4.2.4 Desorption tests and membrane reuse	127
4.2.5 IL-6 pre-concentration and detection	128
4.2.5.1 Method for IL-6 pre-concentration	128
4.2.5.2 Organic Electrochemical Transistor (OECT) for IL-6 detection	130
4.3 Results and discussion	133
4.3.1 Antibody binding capacity of protein G-coupled membrane	133
4.3.2 Immuno-affinity membranes preparation and IL-6 capturing	136

---

4.3.2.1 Quenching step optimization	136
4.3.2.2 Quantification of IL-6 capturing	137
4.3.2.3 Visualization of IL-6 capturing	139
4.3.2.4 Desorption tests and membrane reuse	141
4.3.3 Preliminary results on IL-6 detection	145
4.4 Conclusions and general considerations	146
<b>Overall conclusions</b>	152
<b>APPENDIX</b>	155
<b>Publications</b>	155
<b>Proceedings</b>	155

**List of figures**

- Figure 1.1** Concept of bio-functional membrane preparation
- Figure 1.2** Schematic representation of membrane surface coating by functional layers
- Figure 1.3** Schematic representation of some well-known membrane wet chemical activation reactions: (a) periodate oxidation, (b) epoxy activation, (c) carbonyldiimidazole activation, (d) triazine activation, (e) cyanogen bromide activation, (f) glutaraldehyde activation.
- Figure 1.4** Schematic representation of layer-by-layer deposition process starting i.e. with a positively charged membrane
- Figure 1.5** Schematic representation of biomolecules immobilization methods
- Figure 2.1** A schematic representation of a biosensor and working principle
- Scheme 2.1** Schematic of biosensors classification
- Figure 2.2** Chemical structure of commonly used polymeric membrane materials
- Figure 3.1** SEM image of RC membrane (reprinted from [www.merckmillipore.com](http://www.merckmillipore.com))  
Schematization of membranes bio/chemical functionalization without (I) and with the spacer (I)
- Figure 3.3** Calibration curve of Ninhydrin test obtained by using different contents ( $\mu\text{mol}$ ) of glycine as standard
- Figure 3.4** Schematic representation of the biphasic lipase-immobilized membrane bioreactor
- Figure 3.5** ATR-FTIR spectra of pristine (violet) and oxidized membranes with  $\text{NaIO}_4$  0.02 wt% (blue) and 0.2 wt % (red). A magnification for the marked circle is depicted on the right representing the range from 1750 to 1720  $\text{cm}^{-1}$
- Figure 3.6** ATR-FTIR spectra of oxidized (red) and aminated (violet) membranes
- Figure 3.7** Ninhydrin test of RC-OX-EDA (left) and RC-OX-EDA-GA (right) membranes
- Figure 3.8** Membrane water permeance after each step of functionalization
- Figure 3.9** 3D AFM images of pristine RC membrane (left) and RC-OX-EDA-GA functionalized membrane (right).
- Figure 3.10** Particle size distribution (A) and Electrophoresis in native conditions (B) of BSA
- Figure 3.11** Particle size distribution (A) and Electrophoresis in native conditions (B) of

- protein G
- Figure 3.12** Particle size distribution (A) and Electrophoresis in native conditions (B) of lipase
- Figure 3.13** Particle size distribution (A) and Electrophoresis in native conditions of phosphotriesterase (B)
- Figure 3.14** AFM images of lipase (I) and BSA (II) adsorbed on RC virgin membrane
- Figure 3.15** Absorbance value as a function of reaction time with NaBH<sub>4</sub> to optimize the reduction step ( $\lambda = 562$  nm)
- Figure 3.16** Effect of contact time and initial protein concentration on BSA immobilization onto RC-OX (left) and RC-OX-EDA-GA (right)
- Figure 3.17** Effect of contact time and initial protein concentration on protein G immobilization onto RC-OX-EDA-GA
- Figure 3.18** Irreversible binding isotherm
- Figure 3.19** Effect of contact time and initial protein concentration on lipase immobilization onto RC-OX (left) and RC-OX-EDA-GA (right)
- Figure 3.20** Effect of contact time on phosphotriesterase immobilization onto RC-OX-EDA-GA
- Figure 3.21** Linear plot of pseudo-second order rate for BSA (1 g/L concentration) immobilization on RC-OX-EDA-GA
- Figure 3.22** AFM image of RC-OX-EDA-GA membranes with covalently immobilized BSA after 4 h of incubation. The bearing histograms for the marked squares (a and b) are depicted respectively. (a) Some cluster structures with a depth of around 50 nm and (b) protein filament depth of around 15 nm.
- Figure 3.23** AFM image of RC-OX-EDA-GA membranes with covalently immobilized protein G after 4 h of incubation. The bearing histograms of the marked squares (a and b) are depicted respectively. Protein filaments depth ranges from 6 to 9 nm for the thinnest filaments (b) and from 10 to 20 nm for the thickest ones (a).
- Figure 3.24** AFM images of RC-OX-EDA-GA membranes with covalently immobilized lipase after 1 h (A) and 20 h (B) of incubation. The bearing histograms for the marked squares are depicted for both A and B. Small lipase globular aggregates can be detected after 1 h of incubation with a depth at around 14 nm (A), while large aggregates are detected after 20 h of incubation with a



maximum peak to valley height of around 60 nm.

- Figure 3.25** Immobilized lipase stability
- Figure 3.26** Size distribution of lipase (1 g/l concentration) before (red) and after disaggregation (green).
- Figure 3.27** Effect of multilayers formation on the specific activity of immobilized phosphotriesterase
- Figure 4.1** Schematic representation of the two strategies used for anti IL-6 antibody bioaffinity immobilization without chemical cross-link I) and with glutaraldehyde cross-link II)
- Figure 4.2** Schematic representation of the membrane used as blank to evaluate the specificity of IL-6 binding
- Figure 4.3** Schematic representation of the method used for IL-6 pre-concentration by using the immuno-affinity membrane
- Figure 4.4** (a) Device structure and electrical circuit of a PEDOT:PSS organic electrochemical transistor (OECT); (b) and (c) OECT working principle [26]
- Figure 4.5** Components of the OECT used for the electrical measurements
- Figure 4.6** Schematic of the procedure used for electrochemical IL-6 detection by using the antibody-functionalized gate electrode and the IL-6 concentrated solution
- Figure 4.7** Adsorption isotherm for commercial human IgG onto Protein G-coupled membrane
- Figure 4.8** Linear Langmuir isotherm for hIgG adsorption on protein G-coupled membrane
- Figure 4.9** Scatchard plot
- Figure 4.10** Quenching step optimization. Influence of glycine quenching time on the amount of IL-6 ( $\text{pg}/\text{cm}^2$ ) non-specifically bounded on the membrane surface (RC-PG) at different IL-6 initial concentrations ( $\text{pg}/\text{ml}$ ).
- Figure 4.11** Amount of IL-6 captured by the RC-PG-Ab and RC-PG-Ab-(GA) membranes as a function of initial IL-6 concentration
- Figure 4.12** Capture efficiency of RC-PG-Ab and RC-PG-Ab-(GA) membranes at different IL-6 initial concentrations.
- Figure 4.13** Confocal laser scanning microscopy (CLSM) images of RC virgin

membrane (a), RC-PG-Ab-(GA) membrane (b) and RC-PG-Ab-(GA)-Ag membranes incubated with IL-6 at 31 pg/ml (c), 250 pg/ml (d) and 500 pg/ml (e), all treated with anti IL-6 antibody FITC-conjugated

**Figure 4.14** SDS-PAGE under reducing condition of the samples after the first cycle of acid desorption. 1 – wide range molecular weight marker (1:20 dilution). 2 – anti IL-6 antibody used as standard (65 ng). 3 – mouse IL-6 used as standard (13 ng). 4 – RC-PG-Ab-(GA)-Ag desorption. 5 – RC-PG-Ab-Ag desorption

**Figure 4.15** Amount of IL-6 captured by the RC-PG-Ab-(GA) membrane for repeated use as a function of initial IL-6 concentration

**Figure 4.16** Capture efficiency of RC-PG-Ab-(GA) membrane for repeated use, at different IL-6 initial concentration.

**Figure 4.17** SDS-PAGE under reducing condition of the samples after BSA non-specific adsorption tests on RC-PG-Ab and RC-PG-Ab-(GA) membranes. 1 – wide range molecular weight marker (1:20 dilution). 2 – BSA initial solution. 3 – BSA final solution after incubation with RC-PG-Ab membrane. 4 – BSA final solution after incubation with RC-PG-Ab-(GA) membrane. 5 – RC-PG-Ab\_BSA desorption. 6 – RC-PG-Ab-(GA)\_BSA desorption

**Figure 4.18** OECT response. Comparison between OECT modulation ( $\Delta I/I_0$ ), as a function of gate voltage ( $V_{gs}$ ), using bare Au-gate electrode (black), Ab-gate electrode (red) and Ab-gate electrode after IL-6 binding (blue).

**List of tables**

- Table 2.1** Some applications of membrane biosensors
- Table 3.1** Physicochemical properties of the biomolecules used in this study
- Table 3.2** Summary of results obtained from DLS and Electrophoresis measurements for all concentrations tested of each protein
- Table 3.3** Kinetic parameters for immobilization of BSA and protein G molecules on RC-OX and RC-OX-EDA-GA
- Table 3.4** Hydrolytic activity for free and immobilized lipase
- Table 3.5** Comparison between lipase activity before and after filtration
- Table 4.1** Summary of mass balance results obtained from ELISA quantification experiments

## Sommario

Negli ultimi 50 anni, biomolecole quali proteine, enzimi e anticorpi, sono state immobilizzate su superfici solide per un'ampia gamma di applicazioni, per esempio, in diagnostica, nei processi di separazione e nei bio-processi in generale. Questa combinazione 'ibrida' tra una entità biologica e un materiale di supporto conferisce funzionalità 'biologiche' innovative al materiale sintetico, allo stesso tempo, permette di stabilizzare e di riutilizzare la molecola biologica, offrendo anche la possibilità di modulare le proprietà della superficie solida.

Oggi, un grande interesse è rivolto all'uso di materiali nanostrutturati come supporti solidi. Tra questi materiali, le membrane assumono sempre più maggiore rilievo grazie alle loro proprietà peculiari. Infatti, la loro elevata superficie di scambio per unità di volume e la possibilità di combinare il processo di separazione con il riconoscimento molecolare, hanno permesso di sviluppare sistemi bio-ibridi con molteplici funzionalità, selettività e stabilità per svariate applicazioni.

Questo lavoro di ricerca ha riguardato lo sviluppo di membrane polimeriche bio-ibride allo scopo di *i*) investigare e promuovere avanzamenti nella comprensione delle proprietà delle proteine che influenzano le nanostrutture di membrane nano-ingegnerizzate mediante l'immobilizzazione di tali proteine e *ii*) progettare e sviluppare un sistema con proprietà di bio-riconoscimento e bio-separazione che si basa su interazioni di affinità.

Per la progettazione di una superficie bio-ibrida è necessario considerare diversi parametri. Infatti, l'immobilizzazione di una biomolecola a le relativa attività biologica e stabilità dipendono da diversi fattori, ovvero, il metodo usato per l'immobilizzazione, le proprietà della superficie di supporto, le proprietà della proteina e le condizioni in cui viene condotta l'immobilizzazione. A tal riguardo, in questo lavoro di ricerca inizialmente l'attività è stata focalizzata sullo studio sperimentale delle relazioni tra le proprietà di bulk delle proteine durante l'immobilizzazione covalente e la risultante superficie bio-ibrida. Per lo studio, sono state utilizzate membrane in cellulosa rigenerata funzionalizzate mediante diverse procedure. Le membrane sono state attivate chimicamente secondo due strategie e sono state utilizzate quattro proteine modello (aventi diverse proprietà e diverso comportamento, ovvero, l'albumina di siero bovino, la proteina G, l'enzima lipasi da *C. Rugosa* e l'enzima fosfotriesterasi) per studiare il processo di immobilizzazione e per produrre membrane bio-ibride. È stato studiato l'effetto delle proprietà native delle proteine in soluzione (ovvero la concentrazione, la carica, la dimensione e i fenomeni di aggregazione) su *i*) la cinetica di

legame, *ii*) il rivestimento superficiale della membrana, *iii*) il riarrangiamento strutturale delle proteine, ed è stata testata l'attività delle proteine dopo l'immobilizzazione. La caratterizzazione rigorosa delle proteine in soluzione ha permesso di determinare la dimensione effettiva delle proteine e i fenomeni di aggregazione. Il loro comportamento durante l'immobilizzazione è stato studiato sia in funzione della concentrazione iniziale delle proteine che del tipo di funzionalizzazione di membrana. I risultati hanno dimostrato che l'aggregazione di una proteina in soluzione ha una influenza significativa sulla formazione dello strato di proteina sulla superficie della membrana. Inoltre, sono state realizzati diversi tipi di membrane bio-ibride con diverse proprietà funzionali (in base al tipo di proteina immobilizzata) che hanno mostrato buone performances con potenziali applicazioni nei bio-processi (bio-separazioni, bio-catalisi e bio-sensori). Questo studio è stato ulteriormente esteso allo scopo di progettare sistemi bio-ibridi capaci di riconoscere in modo selettivo molecole target di interesse diagnostico, sulla base di interazioni di immuno-affinità. In particolare, la membrana bio-funzionalizzata con la proteina G è stata utilizzata per sviluppare membrane di immuno-affinità altamente selettive, specifiche, stabili e riutilizzabili per la cattura, il riconoscimento e il rilevamento di molecole coinvolte in processi infiammatori, ovvero, l'interleuchina-6 (IL-6). Sono state sviluppate due diverse strategie in cui la membrana con la proteina G legata è stata utilizzata per l'immobilizzazione sito-specifica ed orientata dell'anticorpo per l'IL-6. Nella prima strategia, dopo l'immobilizzazione dell'anticorpo, la membrana di immuno-affinità è stata usata direttamente per la cattura ed il riconoscimento dell'IL-6. Nella seconda strategia, l'anticorpo per l'IL-6 è stato stabilizzato mediante un cross-link chimico prima di effettuare la cattura ed il riconoscimento dell'IL-6. In altri termini, nel primo caso l'anticorpo è immobilizzato mediante interazioni di affinità con la proteina G, nel secondo il legame dell'anticorpo è stabilizzato mediante legame covalente. Sono stati studiati ed ottimizzati diversi aspetti e parametri: *i*) la capacità della proteina G di legare l'anticorpo; *ii*) le proprietà di bio-riconoscimento di entrambe le membrane di immuno-affinità, ovvero, la capacità delle membrane di catturare l'IL-6 e l'efficienza di cattura; *iii*) la stabilità e la selettività dell'anticorpo e la possibilità di riutilizzarlo; *iv*) il miglioramento della specificità del sistema di riconoscimento mediante la riduzione delle interazioni non specifiche. Entrambe le strategie hanno condotto allo sviluppo di sistemi bio-ibridi altamente efficienti, che hanno dimostrato la possibilità di una applicazione pratica per il riconoscimento ed il rilevamento di molecole target nel campo dei bio-sensori. Tuttavia, solo il legame mediante cross-linking ha permesso di stabilizzare e riutilizzare il sistema di

immuno-affinità. In questo caso, la membrana di immuno-affinità è stata successivamente integrata con un sistema di rilevamento elettrochimico ed è stata utilizzata per concentrare l'IL-6 allo scopo di aumentare la sensibilità di rilevamento del sistema.

## **Contenuti della tesi**

La tesi è stata suddivisa in 4 capitoli:

- Il capitolo 1 tratta l'analisi dello stato dell'arte attuale relativo alle membrane polimeriche bio-ibride. Il capitolo include la discussione di aspetti importanti nello sviluppo delle membrane bio-funzionalizzate e le relative applicazioni adottando una visione critica dei diversi fattori che incidono sul processo di immobilizzazione. Inoltre, sono stati evidenziati gli avanzamenti proposti in quest'area di ricerca.
- Nel capitolo 2 sono stati presentati diversi aspetti relativi all'uso delle membrane nel campo dei bio-sensori, come: le proprietà delle membrane, le loro funzioni, i vantaggi e le applicazioni. Ciò ha condotto ad una considerazione globale ed alla progettazione del lavoro che è stato svolto in questo specifico ambito di ricerca.
- Nel capitolo 3 è riportata l'attività sperimentale relativa allo sviluppo di membrane bio-ibride multifunzionali di cellulosa rigenerata mediante l'immobilizzazione covalente di diverse biomolecole, e lo studio approfondito dell'influenza delle proprietà delle proteine in soluzione sul processo di immobilizzazione nonché sulla struttura delle membrane bioibride. La discussione include: la funzionalizzazione e la caratterizzazione delle membrane; la caratterizzazione delle proteine in soluzione e la correlazione tra le loro proprietà ed il loro comportamento durante l'immobilizzazione; lo studio dell'attività delle biomolecole dopo l'immobilizzazione e la valutazione delle potenziali applicazioni delle membrane bio-ibride sviluppate.
- Nel capitolo 4 è riportata l'attività sperimentale basata sullo sviluppo di membrane di cellulosa rigenerata altamente selettive aventi proprietà di bio-riconoscimento e bio-separazione e la loro relativa applicazione per il rilevamento di molecole target. La discussione riguarda: la progettazione e lo sviluppo di membrane di immuno-affinità; la valutazione delle abilità delle membrane di riconoscere molecole target; lo studio e l'ottimizzazione di diversi aspetti e parametri quali la selettività, la stabilità e la possibilità di riutilizzare le membrane; l'applicazione pratica nella concentrazione e rilevamento di molecole target.

## Summary

Over the last 50 years, biomolecules (including proteins, enzymes, antibodies) have been immobilized on solid support surfaces for a wide range of diagnostic, separation and bioprocess applications. This ‘hybrid’ combination of a biological entity and a support material confers advanced ‘biological’ functionality to the support material and, at the same time, promotes the stabilization and permits the reuse of the costly biological molecule, giving also the possibility to tailor the properties of the solid surface.

Today, a great interest is devoted to nanostructured materials as solid supports, among which membranes are increasingly attractive because of their unique properties. Indeed, their high surface area per unit volume and the possibility to combine separation with molecular recognition permitted the development of bio-hybrid systems with multifunctionality, selectivity and stability for different applications.

This research work has been directed towards the development of bio-hybrid polymeric membranes with the aim *i)* to investigate and promote advances in understanding properties affecting nanoengineered protein-bounded membranes *ii)* to design a system with bio-recognition and bio-separation properties based on affinity interactions.

The design of a bio-hybrid surface needs consideration of various parameters. Indeed, the immobilization of a biomolecule and the related bio-activity and stability are dependent on several factors including the method used for the bio-conjugation, the properties of the surface, the properties of the protein and the immobilization conditions. In this respect, this research work was focused on the experimental study of the relationship between the bulk proteins properties during covalent immobilization and the obtained bio-hybrid surface. Different functionalized regenerated cellulose (RC) membranes as solid supports were used. RC membranes were chemically activated into two different ways and, four model proteins (with different properties and behavior, namely, bovine serum albumin, protein G, the enzyme lipase from *Candida rugosa* and the enzyme phosphotriesterase) were used to study the immobilization process and to produce bio-hybrid membranes. The effect of the proteins bulk properties, including concentration, charge, size and aggregation phenomena, on the *i)* kinetics of binding, *ii)* surface coverage, *iii)* structural rearrangement and the proteins bio-activity after immobilization have been studied.

The in-depth characterization of the proteins in solution allowed the determination of the effective proteins size and aggregation phenomena. The immobilization behavior was investigated as a function of the initial proteins concentration and membrane type and it

---



was correlated to the proteins properties in solution. The results demonstrated that the aggregation behavior of a protein has a significant influence on the bio-layer formation on the membrane surface (including surface coverage, protein distribution and rearrangement and protein bio-activity). Moreover, different types of bio-hybrid membranes have been obtained with different functional properties (since different proteins have been used) showing good performances and potential applications in bioprocesses including bio-separation, bio-catalysis and bio-sensing. This study has been further extended to specifically design bio-hybrid systems able to selectively recognize target molecules of diagnostic interest, on the basis of immuno-affinity interactions. The bio-functional membrane with covalently immobilized protein G was employed to develop highly selective, specific, stable and reusable immuno-affinity membranes for the capture, recognition and detection of molecules involved in inflammatory processes, namely, interleukin-6 (IL-6). Two different strategies have been developed in which the protein G-coupled membrane was used for the site-specific and oriented immobilization of the antibody to IL-6. In the first strategy, after the antibody immobilization, the immuno-affinity membrane was directly used for the IL-6 capturing and recognition. In the second strategy, the anti IL-6 antibody was stabilized by chemical cross-linking before IL-6 capture and recognition. Several aspects and parameters have been studied and optimized: *i*) the ability of protein G to bind the antibody; *ii*) the bio-recognition properties of both immuno-affinity membranes, including the IL-6 capture ability and efficiency; *iii*) the stability and selectivity of the antibody and the possibility of reuse; *iv*) the improvement of the specificity of the system by minimizing non-specific interactions. Both strategies permitted the development of highly efficient bio-hybrid systems showing the possibility of a practical application for target molecules recognition and detection in bio-sensing field, while, only the second strategy permitted the stabilization and reuse of the immuno-affinity system. The latter was further integrated with an electrochemical detection system and was used for IL-6 concentration with the aim to increase the detection sensitivity.

## Dissertation outlines

The thesis has been organized in four main chapters:

- Chapter 1 contains the analysis of the current state of the art related to polymeric bio-hybrid membranes. It includes the discussion of several aspects on the development of bio-functionalized membranes and related applications taking a critical view of different factors affecting the immobilization process. Moreover, the proposed advancements in this research area are highlighted.
- In Chapter 2, different aspects of the use of membranes in bio-sensing field, such as the membrane properties, functions, advantages and applications were assessed, leading to a general consideration and design of the work carried out in this research topic<sup>1</sup>.
- Chapter 3 reports the experimental activity related to the development of multifunctional bio-hybrid regenerated cellulose (RC) membranes by means of the covalent immobilization of different biomolecules and the detailed study of the influence of the proteins bulk properties on the immobilization process. It includes the chemical functionalization and characterization of the membranes; the characterization of the proteins in solution and the correlation of their bulk properties with their behavior during immobilization; the study of the activity of the biomolecules after immobilization and the evaluation of the potential applications of the developed bio-hybrid membranes<sup>2</sup>.
- Chapter 4 reports the experimental activity related to the development of highly selective RC membranes with bio-recognition and bio-separation properties and their application on the detection of target molecules. It includes the design and development of immuno-affinity membranes; the evaluation of the ability of the membranes to recognize target molecules; the study and optimization of different aspects and parameters such as the selectivity, stability and reusability of the membranes; the practical application on target molecules concentration and detection<sup>3</sup>.

Overall conclusions are also included as the final part of the dissertation.

<sup>1</sup>The content of this chapter is part of a book chapter accepted by Pan Stanford Publishing

<sup>2</sup>Part of this chapter has been published in *Colloids and Surface B: Biointerfaces*, 143, 309-317

<sup>3</sup>Part of this chapter has been published in *Biosensors and Bioelectronics*, 92, 54-60

**Chapter 1**

**Introduction to bio-functionalized membranes**

This chapter summarizes the current state of the art related to polymeric bio-functional membranes. The literature analysis was focused on several aspects related to the development of bio-functional membranes concluding with a general consideration and the proposed advancements in this research area.

## **1.1 Membranes and membrane processes**

A membrane is an interphase between two adjacent phases acting as a selective barrier, regulating the transport of substances under the influence of a certain driving force. The driving force is generally due to the difference in chemical or electrical potential in two sides of the membrane, and is expressed in terms of pressure (ultrafiltration, microfiltration, pervaporation), concentration (osmosis), temperature (membrane distillation) or electrical (electro dialysis) potential gradients [1]. Membranes can be made of polymers, metals, inorganic compounds, carbon, ceramic and liquids. They can be homogenous or heterogeneous, symmetric or asymmetric in structure, solid or liquid, can carry a positive or negative charge, or can be neutral or bipolar. Although there is a continuous research and development on new materials for membrane preparation, the most common starting materials used for membranes in industrial applications are cellulosic materials, nylon, polyether sulfone (PES), polysulfone (PS), polypropylene (PP), polyethylene (PE) and polyvinylidene fluoride (PVDF) [2]. Thus, even though ceramic, metal and liquid membranes are gaining more attentions, polymeric membranes are very important as they allow the design of membranes with a wide variability of barrier structures and properties and their low cost.

The commercial application of membranes started in late 1960s. One of the discoveries that decisively influenced the development in the field of membranes and their applications was that of Loeb and Sourirajan [3]. They developed the first asymmetric integrally skinned reverse osmosis membrane. They were the first to introduce the concept of a thin skin layer of separating barrier on the top of a highly porous polymer support. This configuration was associated with a much lower pressure drop than symmetric membranes. After that, membrane based separation techniques gained even more popularity both in industrial processes and academic. Membranes have been used extensively in water desalination, waste water treatment, biotechnology, biomedical industries, pharmaceutical industries, food industries and gas separation [4 – 7]. Membrane based techniques are

numerous and the most common include reverse osmosis (RO), pervaporation (PV), nanofiltration (NF), ultrafiltration (UF), microfiltration (MF) and electro dialysis (ED).

Earlier, membranes were considered to be a separation media based solely on size (UF, MF) or solubility (RO, PV) of species. However, with the advancement of functionalization chemistry and availability of new materials and technologies, it was realized that membrane has more potential than just being used as a separation media. Then, the concept of functionalized membranes was conceived and researchers started modifying membranes to incorporate various kinds of functionality, including biomolecules, to use them in different fields of research including the developing area of biocatalysis and sensing. This research work involves the experimental studies of membranes functionalized with biomolecules, known as bio-functional membranes.

## **1.2 Bio-functional membranes basic concepts**

According to a clear definition given by Butterfield [8], bio-functional membranes are entities in which a biomolecule/collection of biomolecules (such as enzymes, antibodies, etc.), or cells are immobilized onto or into polymeric matrices, cast in the form of porous membranes, to give these relatively chemically inert matrices biological properties. Bio-functional membranes combine the process properties of traditional polymeric membranes and the selectivity, through molecular recognition, of biological membranes. For example, by introducing an enzyme to a membrane, the resulting bio-functional membrane can combine the functions of separation and catalysis together. Besides to the advantages of combining different functionality in a unique operation unit, several benefits can be imparted to the immobilized bio-active molecules. They are confined in a certain defined region of space with a retention of their bio-activity and they can be used repeatedly and continuously [9]. Moreover, an enhancement of their stability under both storage and operational conditions is proven [10]. This permits their application in continuous operation making them more attractive for different applications both in large and in down scale operations.

Bio-functional membranes have been used in catalysis (i.e., membrane-based enzyme bioreactors), separations (i.e., affinity membranes), analysis (i.e., biosensors, metal ion-specific separations), and artificial organs. These uses of bio-functional membranes take advantage of molecular recognition chemistry, prominent in biological membranes. The

application of bio-functional membranes in biocatalysis, separation and analysis are discussed below.

### **1.3 Applications of bio-functional membranes**

#### *1.3.1 Biocatalysis: biocatalytic membrane reactors*

Biocatalytic reactions involving enzymes are becoming increasingly important in different research areas. In particular, the increasing demands of even more environmentally friendly technologies and sustainable production methodologies have increased the use of enzyme in industrial processes. Enzymes are natural biocatalysts that offer substantial advantages over chemical catalysts in that they are derived from renewable resources, are biodegradable, work under mild conditions of temperature and pH, and offer improved selectivity in both reactant and product stereochemistry. These attributes have resulted in myriad applications including food, pharmaceutical and biotechnological industries. The main problems of using enzymes in industrial processes are related to their lack of stability (under harsh conditions), the impossibility of reuse in multiple reactions and sometimes the enzyme inactivation and the difficulty of products purification. Some of these issues can be overcome by the immobilization of the enzymes [11]. Using a membrane as support for enzyme immobilization can simultaneously realize the function of catalysis and separation. Moreover, the high surface area-to-volume ratio of membranes ensures a higher amount of immobilized catalyst resulting in an increased surface reaction. The resulting biocatalytic membrane is integrated in reactors known as biocatalytic membrane reactors (BMRs) which can be used for production, processing and treatment operations. An important feature made possible by BMRs is process intensification [12]. The continuous removal of the products can also increase the productivity of product-inhibited enzymes. Moreover, this continuous removal can shift the equilibrium of a reaction towards the product side and thereby increasing the productivity of the whole process [12]. A detailed review article has been published by Giorno and Drioli [13] describing many aspects and applications of biocatalytic membrane reactors. They are used in different industrial sectors such as in agro-food (for reducing the viscosity of juices by hydrolysing pectins; for reducing the lactose content in milk and whey by its conversion into digestible sugar; for the treatment of musts and wines by the conversion of polyphenolic compounds and anthocyanes; for the removal of peroxides from dairy

products), for pharmaceuticals production (such as amino acids, antibiotics, anti-inflammatories, vitamins, etc.), in waste-water treatment and so on.

Despite all these advantages, only a small part of industrial biocatalytic processes utilize immobilized enzymes in one of their processes [14]. To enhance the acceptability of immobilized enzymes in industrial processes, the major challenge is to find the immobilization techniques and operational conditions that suit the ground requirements [12].

### *1.3.2 Separation: affinity membranes*

The rapid growth in biotechnology and the wide potential of proteins for applications in different areas, such as in medicine, food and pharmaceutical industries, result on an increasing demand for efficient and reliable tools for separation and purification of proteins from mixtures as well as for techniques that can be easily scaled up from laboratories to industrial level [15]. Among different separation technologies, affinity chromatography is the most widely used. This kind of chromatography is associated with highest level of selectivity as bio-specific (biological) interactions are generally used to achieve a fine purification of proteins; it is the only technique that permits the purification of proteins based on biological functions rather than individual physical or chemical properties [16,17]. In this technique, a ligand, that has specific interaction with the target protein, is permanently bounded onto an inert matrix and specifically recognizes the molecule of interest that can be separated. When mixture of proteins percolates through the column, only the target protein is captured. In next step, the target protein is eluted by changing the operational parameters (i.e., pH, ionic strength, etc.). A detailed review article has been published by Varilova and co-workers [18] describing various kinds of solid matrix used for affinity chromatography of proteins, including membranes. The integration of membranes and affinity chromatography provides a number of advantages over traditional affinity chromatography with porous-bead packed columns [19]. Affinity membranes combine the outstanding selectivity of affinity interactions with the high productivity associated with filtration membranes. The distinct benefit of membrane chromatography is the shorter diffusion times than those obtained in column chromatography, as the interactions between biomolecules and ligands on the membrane occur in convective through-pores, rather than in diffusion inside the pores of an adsorbent resin. As a result of the convective flow of the solution through the pores, the mass transfer

resistance is reduced. This results in rapid processing, which greatly improves the adsorption, washing, elution, and regeneration steps. Due to the macroporous structure of the membrane support, membrane chromatography has a lower pressure drop, higher flow-rate, and higher productivity than column chromatography [19].

Affinity membranes have been used for several different applications such as purification of biomolecules, removal of unwanted substances from biological fluids and also for small scale analytical separations. The most common application is the separation and purification of proteins for large scale production [20].

### *1.3.3 Analysis: biosensors*

Biosensors are highly selective chemical sensors which involve biological elements in their sensing layer [21]. They are able to selectively recognize a target analyte in a complex mixture, leading to a physical or chemical signal. This signal is converted by the transducer into an electrical output which can be correlated to the concentration of the target species. In designing the bioactive layer of a biosensor system, membranes play an important role. Indeed, bio-functional membranes incorporating enzymes or affinity species are considered the cornerstones of most biosensors [22]. In several cases, the membrane not only serves as a matrix for supporting the biological element but also ensure to a certain extent additional selectivity to the whole system [23]. They have been used in several detection systems, such as for glucose detection, nucleic acid detection, bacteria detection [24]. Since the second part of this research work was focused on the development of bio-functionalized membranes for bio-sensing, a more detailed analysis of membrane application in biosensors is addressed in chapter 2.

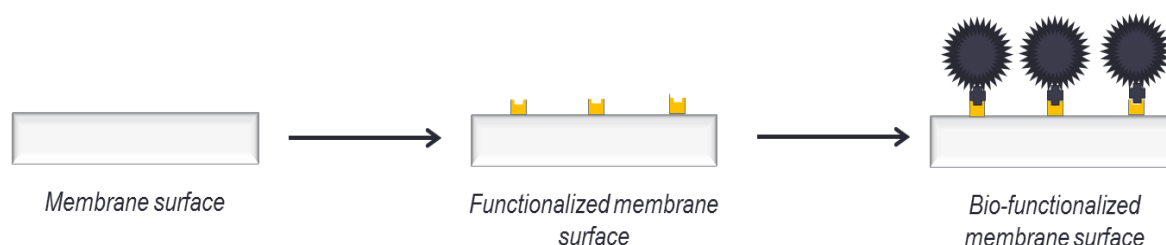
## **1.4 Preparation of bio-functional polymeric membranes**

Membranes are required to have some specific properties for a specific application. The type of polymer used for membrane preparation strongly influences the characteristics of a polymeric membrane. Polymeric membrane can be made of synthetic polymers, such as nylon, polysulfone, poly(methyl-methacrylate), polyethylene, polyamide, polypropylene, polyvinylidene fluoride polyaniline, or natural polymers, such as cellulose and its derivatives, chitosan, etc. All the mentioned polymeric materials have been used to prepare membrane for different applications, including biocatalytic membrane reactors, biosensors, affinity separations, as they have excellent physical-chemical bulk properties



[25-31]. However, in most cases, the resulting membrane does not possess the appropriate surface properties required for a particular purpose, like proteins immobilization. Indeed, the immobilization of biomolecules is only possible on a reactive surface provided of functional sites (reactive functional groups), that are regions where the membrane is able to interact with the protein. Because of the inert nature of most commercial polymers, these binding regions are not always present on the native membrane, then a surface modification of the membrane is sometimes necessary. Therefore, prior to attachment of a bioactive compound, membranes generally need to be undergo surface modification/activation [32].

While the end use of a bio-functional membrane may vary with each application, the overall concept of bio-functional membrane preparation can be the same, as illustrated in figure 1. Therefore, the first step is to fabricate or to select the proper polymeric membrane with bulk structure matching the needs of the end use. The second step is to perform and optimize surface functionalization techniques in order to introduce the desired type and quantity of reactive functional groups and the third step is then to attach the bio-active molecule.



**Figure 1.1** Concept of bio-functional membrane preparation

The different available techniques for membranes functionalization and the proteins immobilization are discussed below.

#### *1.4.1 Membrane surface functionalization/activation*

Membrane surface modification techniques aim to introduce functional groups on the membrane surface and thereby improving its surface properties without actually affecting the bulk structure of the base membrane. The main advantage of functionalization is the

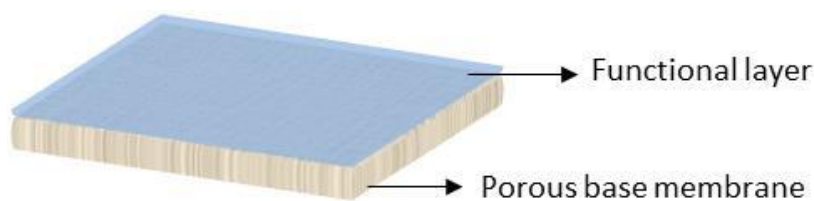
versatility of the active groups. The membrane functionalization can be tailor-made to impart the desired functionality from a pool of active groups/ moieties, depending on the type of functionalization method, immobilization and final application. Moreover, an ideal surface for proteins immobilization should possess further requirements, such as hydrophilicity, inertness toward proteins ease of derivatization, biocompatibility and resistance to microbial attack [11]. Surface modification methodologies can also have additional advantages in terms of improving these properties.

In order to achieve these improvements several physical or chemical approaches have been proposed, e.g. coating, chemical treatment, self-assembly, plasma treatment, UV irradiation and surface graft polymerization. Most of these techniques allow the introduction on the membrane surface of specific functional groups able to react with the proteins.

#### *1.4.1.1 Coating*

Coating is a physical functionalization method based on a very simple principle and operation [33]. It consists on the physical deposition of hydrophilic and/or biocompatible materials (such as dextran, chitosan, poly ethylene glycol (PEG), poly vinyl alcohol (PVA), etc.) on the top of the base membrane (figure 1.2) via one or more of the following mechanisms:

- adsorption-adhesion, the functional layer is only physically attached/fixed on the base polymer membrane, for example by casting method; the binding strength can be increased via multiple interactions between functional groups in the macromolecular layer and on the membrane surface.
- Interpenetration via mixing between the added functional material and the base polymer in an interphase. For the modification of the membrane, physically assisted methods such as plasma polymerization, chemical vapor deposition (CVD) are often applied. For example, when using plasma-assisted methods, interphase layers between the base polymer and the added polymer are involved.
- Mechanical interpenetration of an added material layer and the pore structure of the membrane. The in situ crosslinking copolymerization of hydrophilic acrylate monomers in macroporous hydrophobic membranes is one of the most representative and important example as it leads to a permanent hydrophilization of the pore surface by a thin polymer layer.



**Figure 1.2** Schematic representation of membrane surface coating by functional layers

By coating these functional materials on the membrane, the surface property of the membrane could mutate from hydrophobic or non-biocompatible to hydrophilic and biocompatible. Some examples include the modification of hydrophobic membranes, such as polysulfone [34], polyethersulfone [35], polyvinylidene difluoride (PVDF) and nylon [36], with hydrophilic polymer coating such as chitosan, dextran, etc. These modified membranes have been used for example for the development of affinity membranes for antibody purification, showing improved fouling resistance and biocompatibility [36]. However, this method cannot gain a stable surface as the materials absorbed on the membrane surface run away easily due to the relatively weak interactions [37]. Moreover, the use of this modification method is sometimes limited to improving surface properties like hydrophilicity, biocompatibility, fouling resistance, without introducing specific functional groups for proteins immobilization.

#### *1.4.1.2 Wet chemical*

Wet chemical treatment is one of the most common methods for membrane functionalization/activation and the modified surface is relatively stable. Usually the modifications allow retaining mechanical properties of the membrane while changing the interfacial properties. In wet chemical surface modification, the membrane is treated with liquid reagents to generate reactive functional groups on the surface, such as amino, epoxy, azido, carboxyl, etc. The introduction of such functional groups generally affects the hydrophilicity of the membrane surface and can be used for biomolecules immobilization. This classical approach to surface modification does not require specialized equipment and thus can be conducted in most laboratories. It is also more capable of penetrating porous three-dimensional substrates than plasma and other energy source surface modification techniques [38]. Chemical treatments include oxidation, addition, substitution and hydrolysis. Oxidative treatment is the dominant means for chemically modified reactions. Wet chemical oxidation involves the use of nitric acid, sulfuric acid, phosphoric acid, alone

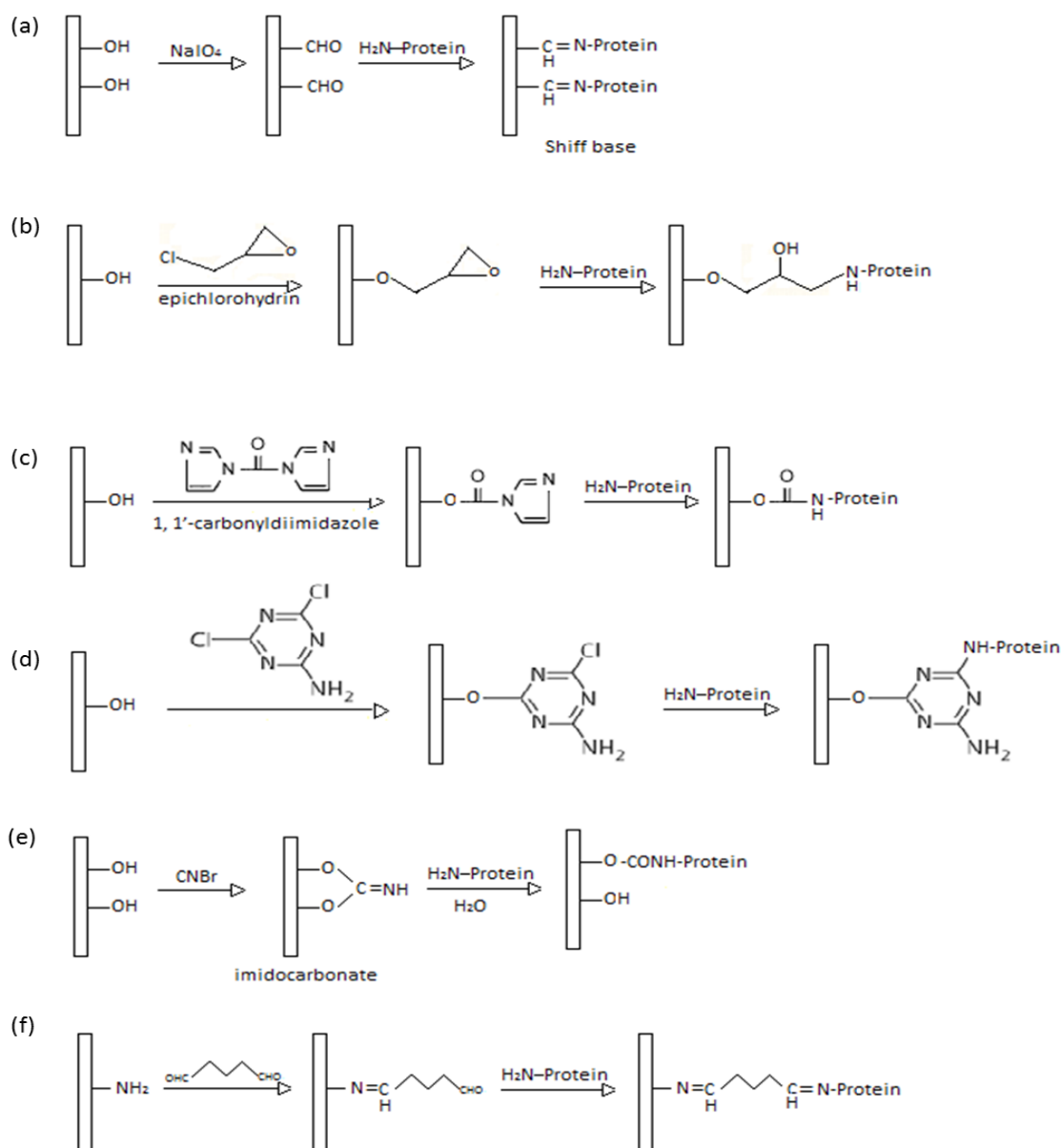
or in combination with hydrogen peroxide, sodium hypochlorite, permanganate, chromate or dichromate of potassium, transition metal nitrates, etc. [32]. The other reactions are also very useful for introducing functional groups to membranes, such as the hydrolysis of nitrile groups by sodium hydroxide or amine to generate carboxyl, acrylamide or amide groups. The activation processes are generally designed to generate electrophilic groups on the base membrane which, in the immobilization step, can react with the strong nucleophiles groups on the proteins to form covalent bonds.

Some well-known membrane wet chemical activation techniques are described below and the different chemical reactions are schematized in figure 1.3.

- *Periodate oxidation*: Membranes containing vicinal cis-hydroxyl groups (such as cellulose) can be selectively activated by oxidizing with sodium periodate to form dialdehyde groups. This aldehyde activated membrane can then react with any primary amine containing molecule, following Schiff's base reaction [39], [40]
- *Epoxide activation*: Membranes containing free hydroxyl groups or primary amine (such as cellulose, poly-(ethylenevinyl alcohol), nylon) can be activated with epoxide group, by reacting with epichlorohydrin or 1, 4-butanediol diglycidol ether. The resultant epoxide group can react further with any amine containing molecule, such as protein [41], [42].
- *Carbonyldiimidazole activation*: Membranes containing hydroxyl and primary amine can again be activated by reacting with 1, 1'-carbonyldiimidazole, which releases its first imidazole group in this reaction. The attached active group further participates in nucleophilic substitution with any primary amine containing molecule, such as protein, to release its second imidazole group and form very stable amide linkage [43].
- *Triazine activation*: Another approach of activating membranes containing hydroxyl and primary amine is known as triazine activation. In this technique, 2, 4, 6-trichlorotriazine (cyanuric chloride) is reacted with the membrane to attach it in the solid matrix by releasing highly reactive first chlorine. Since, the second and third chlorines are now attached with the membrane and available for substitution, this forms a highly reactive system [44].
- *Cyanogen bromide activation*: Membranes containing hydroxyl groups can be again activated by reacting with cyanogen bromide to form cyanate esters or

imidocarbonates that react readily with primary amines of protein molecules, under mild conditions [45].

- *Glutaraldehyde activation*: Glutaraldehyde is a bi-functional reagent that can be used for the activation of membranes containing amino groups. Glutaraldehyde may then react with different protein moieties, mainly involving primary amino groups of proteins by formation of Schiff bases, although it may eventually react with other groups (thiols, phenols, and imidazoles) [46].



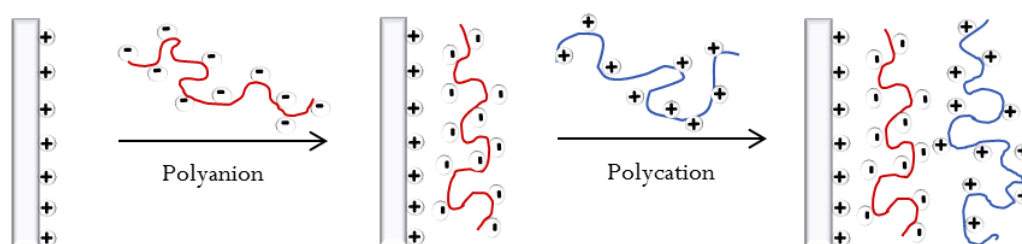
**Figure 1.3** Schematic representation of some well-known membrane wet chemical activation reactions: (a) periodate oxidation, (b) epoxy activation, (c) carbonyldiimidazole

activation, (d) triazine activation, (e) cyanogen bromide activation, (f) glutaraldehyde activation.

#### *1.4.1.3 Self-assembly*

Self-assembly is a common phenomenon in nature, indeed, many super-molecular structures and complex systems are formed by self-assembly. It is a relatively new technique for membrane surface modification. The technique involves self-assembled monolayer (SAMs) and layer by layer assembly (LbL). SAMs are ordered molecular assemblies formed by the adsorption of an active surfactant on a solid surface [47], [48]. The order in the two-dimensional systems is produced by a spontaneous chemical synthesis at the interface, as the system approaches equilibrium leading to a closely packed, well-ordered, and stable configuration on the surface [49]. The LbL is a related method developed for film assembly on solid surfaces by means of alternate adsorption of linear polycations and polyanions, or bipolar amphiphiles [50] (figure 1.4). The LbL process is simple and can be performed in mild conditions using environmentally friendly reagent and can be adopted to almost any surface as long as surface charges are present. It involves repeated dipping of a charged substrate, in this case a charged membrane, into polyelectrolyte solutions. Oppositely charged polyelectrolytes are capable of co-assembly, directed by multivalent ionic interactions, resulting in supramolecular architectures that can be built up with precise control simply by varying the nature of the polyelectrolyte solutions. Thickness, surface charge, and composition can be controlled through changing the type of polyelectrolytes, the number of dip/wash cycles and the reaction conditions [51]. A vast range of functional groups can be incorporated within the structure of the film. The structure exhibits negative and positive charges, which may allow the binding of charged molecules, such as proteins, for example by electrostatic adsorption [52].

Traditional layer-by-layer assemblies are synthesized using alternate polyanion/polycation deposition on the membrane external surface. A more recent alternative is to grow the multilayer assemblies inside the membrane pores, as the internal membrane area is much higher, to increase the reactive surface area for proteins immobilization. The polyelectrolytes are transported through the membrane under convective conditions, and the film grows perpendicular to the direction of solvent flux until the desired pore coverage is achieved [52].



**Figure 1.4** Schematic representation of layer-by-layer deposition process starting i.e. with a positively charged membrane

#### 1.4.1.4 Plasma Treatment

Plasma is a high energy state of matter, in which a gas is partially ionized into charged particles, electrons, and neutral molecules [53]. Plasma can provide modification of the top nanometer of a polymer surface without using solvents. The type of functionalization imparted can be varied by selection of plasma gas (Ar, N<sub>2</sub>, O<sub>2</sub>, H<sub>2</sub>O, CO<sub>2</sub>, NH<sub>3</sub>) and operating parameters (pressure, power, time, gas flow rate) [54]. Thus, plasma surface modifications exhibit multifunctional chemistries (oxidation, degradation, changes in the carbon/hydrogen ratio). The unique advantage of plasma modification is that the surface properties and biocompatibility can be enhanced selectively while the bulk attributes of the membrane remain unchanged as these chemistries occurs only at the contact point between plasma and surface of the solid materials. Plasma treatment for the surface modification of membranes includes plasma sputtering, etching, implantation, and spraying [32].

#### 1.4.1.5 UV irradiation

When exposed to UV light, polymer surfaces generate reactive sites which can become functional groups upon exposure to gas or can be used to initiate UV-induced graft polymerization. UV irradiation has been used to introduce carboxylic acid functionality to PMMA [55], as well as to activate PS surfaces for enzyme immobilization [56]. These techniques require only simple equipment, but are only able to modify a shallow region near the membrane surface.

#### 1.4.1.6 Surface Graft Polymerization

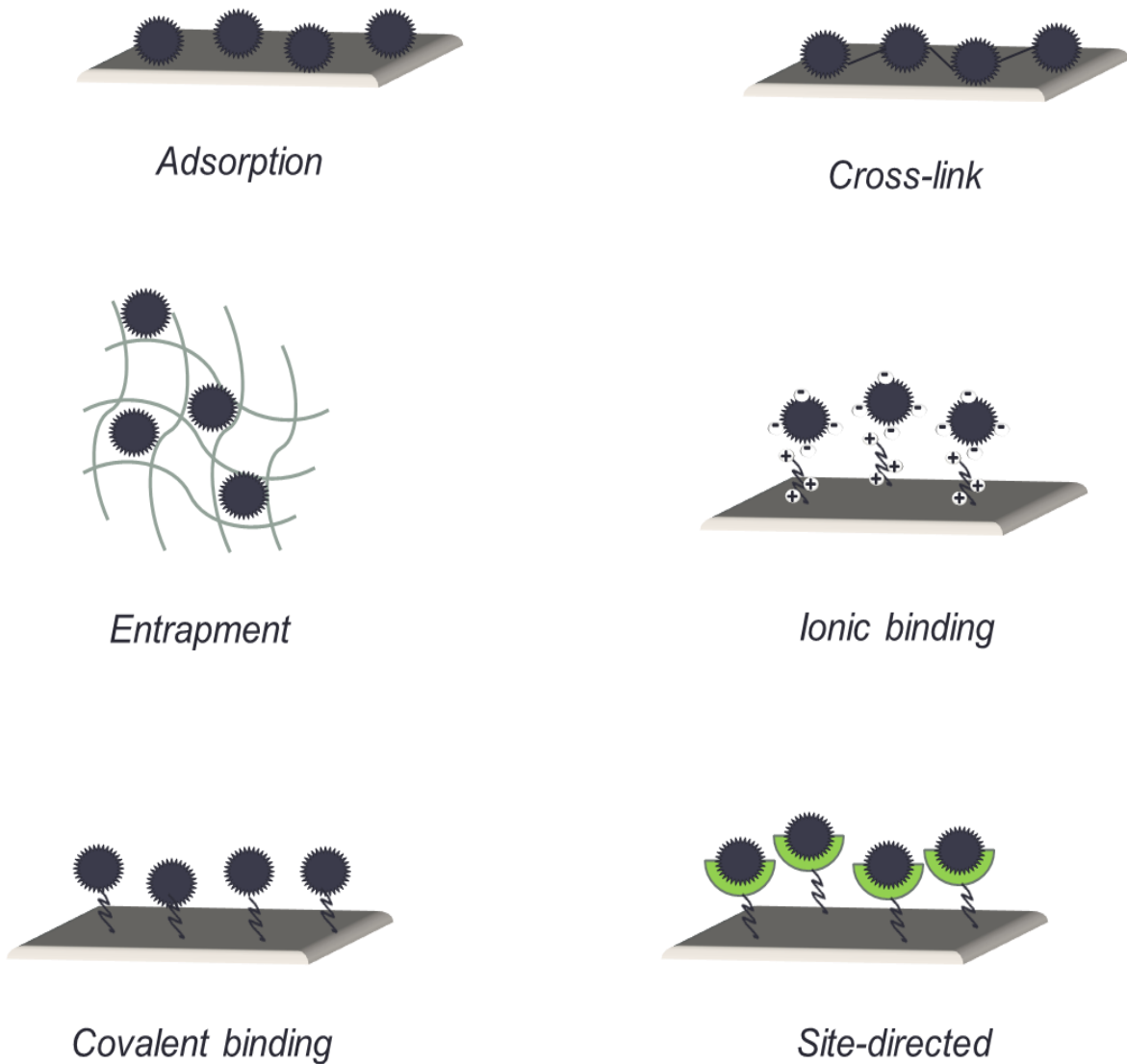
Grafting generally involves the chemical attachment of hydrophilic compounds to the membrane surface, in view of increasing its hydrophilicity [57]. Grafting methods are usually classified into ‘grafting-to’ and ‘grafting-from’ processes [32]. ‘Grafting-to’ is

performed by coupling preformed polymer chains to the membrane surface by one of the following strategies: 1) direct coupling on reactive side groups or end groups of the membrane material; 2) primary functionalization of the membrane (introduction of amino, aldehyde, epoxide, carboxyl or other reactive groups on the surface) and subsequent coupling; 3) adsorption on the membrane surface and subsequent physically activated coupling. While, during ‘grafting-from’, monomers are polymerized using an initiation at the membrane surface. The techniques require the prior introduction of functional groups on the membrane surface. The reactive sites can be generated in many ways including chemical treatment, UV irradiation, plasma treatment. For example, UV initiated photopolymerization was used to coat a polyurethane (meth)acrylate and GMA blend on a polypropylene membrane to have a better surface hydrophilicity, biocompatibility, strength and chemical stability. This membrane was further used for lipase immobilization [58]. Compared with the physical modification methods such as coating, an important advantage is the long-term chemical stability of the modified surface ensured by the covalent attachment of polymer chains onto the membrane surface which avoids detaching.

### *1.4.2 Biomolecules immobilization*

Once the membrane is functionalized/activated, the next step for the development of a bio-functional membrane is the immobilization of the bio-active molecule. The selection of the immobilization method may depend on different factors, such as the type of reactive groups/moieties introduced, the impact of the immobilization on the protein bio-activity, stability and then, the final application of the bio-functional membrane. Different strategies can be adopted for biomolecules immobilization: adsorption, cross-linking, entrapment, ionic binding, covalent binding, site-directed. A schematic representation and description of such methods is presented below.





**Figure 1.5** Schematic representation of biomolecules immobilization methods

**Adsorption:** The physical adsorption is the most simple and inexpensive method for immobilizing biomolecules. Proteins adsorb on the membrane surface via weak intermolecular forces including hydrogen bonds, hydrophobic, Van der Waals interactions or a combination of them. It can be also performed on unmodified membranes resulting in a more economic process. The method is very simple as it consists on the static incubation of the protein solution with the membrane or the continuous flow of the solution over the membrane surface. However, the resulting protein layer is generally heterogeneous and randomly oriented which sometimes may result in low reproducibility and reduction of protein activity. Indeed, proteins can form multiple contacts, in different orientations, with

the surface, resulting, in some cases, in conformational changes and reduction of accessibility to the functional binding sites [59]. Another important disadvantage of this immobilization method is the poor stability of the protein layer. Since the interactions between the membrane and the biomolecule are relatively weak, the leaching of the adsorbed protein generally occurs by simply changing the reaction conditions (e.g., pH, ionic strength, temperature, or polarity of the solvent).

**Cross-link:** Sometimes, to increase the stability of adsorbed proteins, adsorption is followed by intermolecular crosslinking of the biomolecules with bifunctional reagents (i.e., glutaraldehyde). This technique is sometimes associated with loss of active properties of immobilized biomolecules, while increasing its stability.

**Entrapment:** The entrapment is a physical immobilization method based on the passive trapping of the biomolecule into the membrane pores, involving some advantages such as the ability to entrap large amounts of biomolecules with a relatively enhanced thermal and chemical stability and the easy of preparation. The main problems of this method are the possibility of occlusion of the membrane pores, mass transfer limitations and the possible leakage of the biomolecules.

**Ionic binding:** This method consists on the electrostatic interaction between the membrane charged surface and a biomolecule that has a net opposite charge. A protein molecule becomes positively charged at any pH below its isoelectric point (PI) and negatively charged at any pH above its PI. This characteristic can be exploited to immobilize biomolecules to any charged surface. The method is simple but, in general, it is difficult to find conditions under which the biomolecule remains both strongly bound and fully active. As in the case of adsorption, the ionic binding can be reversed by relatively low ionic strengths or by mild changes in pH.

**Covalent binding:** The covalent binding is the most widely used immobilization method. The main advantage of this method is that, because of the highly stable nature of the bond formed between the protein and the membrane, the biomolecule is not released into the solution upon use. The binding is generally formed between the reactive functional groups, already present or properly introduced, of the membrane surface and the functional groups of exterior amino acid residues of proteins, resulting in an irreversible and stable binding. The reactive groups of amino acids that can be involved are primary amine (N-terminus

and  $\epsilon$ -amino group of Lysine), thiol (Cysteine), carboxylic acid (C-terminus, Glutamic acid and Aspartic acid), hydroxyl (Serine and Threonine), phenol (Tyrosine), imidazole (Histidine). Based on the type of functional group involved, several bioconjugation techniques have been developed for the covalent immobilization of biomolecules [60]. The most commonly used are the *Amine Chemistry*, *Thiol Chemistry*, *Epoxy Chemistry* and *Carboxyl Chemistry*. Moreover, the development of numerous bi-functional reagents (or cross-linkers) has expanded the array of usable conjugation chemistries [38]. Cross-linkers can link the bioactive molecule directly to the functionalized membrane (zero-length cross-linkers), or they can introduce a spacer of several angstroms with the additional advantage of increasing protein mobility. One disadvantage of this method is the possibility of reduction of protein activity, mostly due to the linkage with amino acid residues located on the active site of the protein and the multiple binding involving simultaneously many amino acid residues that may restrict the conformational flexibility of the protein. However, in some cases, this multipoint covalent immobilization has demonstrated to contribute to protein stabilization [60].

**Site-directed:** This immobilization technique allows to retain the activity of the biomolecule by means of a selective interaction and proper orientation on the membrane surface. It is based on the affinity binding between the biomolecule and a complementary affinity ligand or the modification of the biomolecule with specific groups on a specific location. The procedure often requires the prior covalent binding of an affinity ligand to the membrane.

### 1.5 Factors affecting proteins immobilization

In the previous section the different steps that are involved on the preparation of a bio-functional membrane have been described. One of the key requirements for a reliable application of a bio-functional membrane is to bind proteins without losing their bio-activity. It is well known that the activity and the stability of a protein depend on both the immobilization method and the type of polymeric matrix. A lot of detailed review articles have been published describing recent techniques on proteins immobilization on different surfaces [62], [63]. The interactions of biomolecules with solid surfaces and the related bio-activity may be influenced by several factors. As the number of applications employing biomolecules immobilized to solid surfaces has increased, so too has the understanding of the factors that impact activity, as well as strategies to manipulate the

material–protein interface [64]. Along with the method used for proteins immobilization, the main parameters that influence the immobilization process and the protein performances include the surface properties, the protein properties and the immobilization conditions (the medium).

### *1.5.1 Surface properties*

The surface properties of the membrane are of primary importance on the performances of immobilized bio-active molecules. They have a great impact on protein conformation, re-orientation and structural rearrangement on the surface. The choice of the membrane support for proteins immobilization is governed by several factors, among which is the relative hydrophilicity/hydrophobicity of the polymer from which the membrane is formed. Proteins are amphiphilic in nature, having both hydrophilic and hydrophobic amino acids capable of interactions at a solvent-material interface. The structure of a water-soluble protein has a hydrophobic core (non-polar amino acid residues that preferentially enter the interior of the molecule to shield themselves from the water) in which side chains are buried from water, which stabilizes the folded state. Charged and polar side chains are situated on the solvent-exposed surface where they interact with surrounding water molecules. In general, protein molecules change their conformations to a large extent on hydrophobic surfaces than on hydrophilic surfaces. This is because the hydrophobic part of the protein and the hydrophobic part of the surface strongly interact together resulting in a structural rearrangement and a less compact protein conformation [65]. Thus, the general trend is to minimize the hydrophobicity of the membrane, which can often lead to non-specific protein binding to the polymer surface, for example lack of binding specificity and enhanced probability for protein denaturation can result [66]. Despite the general assumption, retention of immobilized proteins activity is not just a simple matter of rendering a material hydrophilic. Indeed, enzymes have been shown to lose activity on both hydrophilic and hydrophobic surfaces [64]. The so called “soft proteins”, have shown to change conformation also on hydrophilic surfaces, thus the conformational stability of a protein is also important [65]. Other important factors, related to the surface, to be considered when immobilizing a bio-molecule are the type of functional groups and the type and density of surface charges.

When the immobilization is performed by chemical coupling, the functional groups of the surface react with amino acid residues of the protein that can be located near or on the

active site of the biomolecule. Then, the type of bioconjugate chemistry can impact the conformation of the immobilized protein, and therefore affect retained activity.

When surfaces are charged, electrostatic interactions play an important role, because proteins are also charged (depending on the solution pH), leading to attraction or repulsion of individual ionic amino acids on the protein surface, or of the whole protein. When a biomolecule is in contact with the surface, minimizing or maximizing those interactions can lead to distortion of its structure or change of its orientation [67]. Both the type of charge (positive or negative) on a material surface as well as charge density can alter the enzyme activity upon immobilization. For example, the activity of lactase bound to an anionic support has been shown to be lower than activity when bound to a cationic support, suggesting a negative charge may alter the conformation of the enzyme [68]. On the contrary, an enzyme like alpha-chymotrypsin has shown to have better retained activity on negatively charged surface when compared to a positively charged surface [69].

### *1.5.2 Protein properties*

Proteins are complex copolymers that are made up of four levels of structure, designated as the primary, secondary, tertiary, and quaternary structures [70]. The folding of secondary structures into tertiary structures, corresponding to spatial arrangement of amino acids, enables the formation of active sites able to perform specific biological functions. When interacting with a support surface, proteins often lose, or appear to lose, their native structure/function due to protein re-orientation [64]. A lot of papers and review articles have been published describing the behavior of proteins at solid-liquid interfaces, mostly dedicated to proteins adsorption [71], [72], [65]. The complex internal and surface architectures of proteins make it difficult to individualize those characteristics of proteins in aqueous solution which are of primary importance in their adsorption behavior. Proteins surface properties are clearly important since portions of the protein exterior will initially have the closest and strongest interaction with the support surface. Important protein surface properties include the effective surface area (size) the surface hydrophobicity/hydrophilicity and charge distribution, and the presence and number of any surface groups which can specifically interact with groups in the support/solution interface [73].

Due to a defined folding into their secondary and tertiary structure proteins contain a specific distribution of hydrophobic, hydrophilic, positively charged and negatively

charged side chains and surface groups. Some of these properties like the folding state or the number of positive and negative charges inside proteins can vary in different environmental conditions depending on pH, ionic strength, or temperature [72]. Thus, many of the protein properties are strictly dependent on the medium.

An important aspect connected with protein interaction with solid surfaces is the aggregation of proteins into oligomers of a few monomers or into clusters of up to several hundreds of protein monomers. Protein molecules can aggregate with each other. This process is important in many ways [74]. During immobilization on solid surfaces, this process can influence the adsorption/binding kinetics as well as the resulting layer structure. The formation mechanisms of these protein clusters may include either the diffusion of surface bound molecules towards precursor aggregates or the direct adsorption of bulk proteins adjacent to other surface bound proteins or protein aggregates. This implies that these protein clusters evolve directly on the surface mediated by strong protein–protein interactions [72], [75]. An alternative mechanism that can lead to two-dimensional clusters consist of the formation of larger protein assemblies in the solution which subsequently deposit onto the surface [72], [76]. So far it has been pointed out that protein clustering or aggregation can be a surface induced process. However, protein clusters have also been reported as stable, ordered or amorphous aggregates that grow in a protein solution [77].

By understanding the nature of the specific protein to be immobilized, with respect to the unfolding mechanisms that may occur when in contact with the surface of a material, strategies can be developed to retain or improve activity of the immobilized conjugate.

### *1.5.3 Medium*

The conditions under which the experiments are conducted have a decisive influence on the immobilization behavior. External parameters are basically temperature, pH, ionic strength, and buffer composition. These parameters are fixed if true physiological conditions are mimicked; however, some experimental studies are conducted at arbitrary conditions. In adsorption experiments, the temperature has been demonstrated to have an effect on both the equilibrium state and the kinetics of protein adsorption. With higher temperature, an increased adsorption rate can be expected due to an accelerated diffusivity of proteins towards the support surface. However, immobilization experiments are

generally performed at room temperature where the denaturation of proteins is usually negligible.

The other parameters have been already mentioned when considering the protein properties. The pH determines the electrostatic state of proteins. When the pH equals the isoelectric point (pI) of a protein the numbers of negative and positive charges are in balance resulting in a net neutral molecule. At low pH conditions ( $\text{pH} < \text{pI}$ ) proteins are positively charged whereas at high pH conditions ( $\text{pH} > \text{pI}$ ) proteins are negatively charged.

It is well known that the buffer composition can influence the structural stability of a protein in solution, thus in general it should be chosen an “inert buffer” [78]. Moreover, if a chemical reaction between the support and the protein is desired for immobilization (i.e., covalent immobilization) the buffer should not interfere in the reaction. For example borate may interfere in the aldehyde–amine reaction; amino compounds (Tris, ethanol amine) may modify epoxy supports or compete with the Lys by aldehyde groups [61].

The influence of the ionic strength on the proteins-surfaces interaction is mostly studied in the cases where electrostatic interactions are the dominant driving force for adsorption. The ionic strength may influence protein-protein, surface-protein and intramolecular interactions. It has been demonstrated that protein adsorption, which is controlled by electrostatic attraction, decreases in the presence of salt because electrostatic affinity between sorbent and protein decreases [65]. Moreover, high ionic strength conditions increase the tendency of proteins to aggregate [79].

## **1.6 Concluding remarks and advancements**

From the background study of the research area related to bio-functionalized membranes, the following observations can be made:

- There is an increasing interest on the development of bio-functionalized membranes for applications in several fields including biocatalysis, affinity separations and biosensors.
- In the design of a bio-hybrid surface, the choice of the appropriate support, in terms of materials, reactive groups as well as the immobilization conditions are of primary importance. A lot of functionalization techniques have been developed to improve membrane surface properties. Apparently, most commonly used synthetic

membranes are less suitable for biomolecules immobilization as they exhibit undesirable surface properties responsible for strong non-specific adsorption of proteins and increased probability of protein denaturation. On the other hand, supports based on natural materials may exhibit higher compatibility with biological molecules.

- In spite of the plethora of studies dedicated to the immobilization of proteins on polymeric surfaces to date, there is still a considerable lack of knowledge on how to design biomolecules anchored to membranes producing large active surface area without affecting bio-reactivity. It is still necessary to in-depth explore the boundary conditions for the control of protein coverage, distribution and orientation and, then, related bio-reactivity. Indeed, the properties of the final protein layer are influenced not only by protein membrane surface interactions, but also by protein-protein interactions. Necessarily, the structural properties of the protein in relation to the bulk conditions must be, therefore, considered. Moreover, most of these type of studies are dedicated to protein adsorption on surfaces. However, for many applications, the long term stability of the bounded biomolecule is a key requirement, thus the covalent immobilization is preferred.
- This research work contributed on understanding the behavior of proteins at a membrane surface during covalent immobilization by studying the relationship between the protein properties in solution and during immobilization, as presented in chapter 3.



## References

- [1] Mulder, M., *Basic Principles of Membrane Technology* Kluwer Academic Publishers, Netherlands, 1991
- [2] Kesting, R.E., *Synthetic Polymeric Membranes*, 1971
- [3] Loeb, S., Sourirajan, S., *The preparation of high-flow semi-permeable membranes for separation of water from saline solutions*, 1964
- [4] Bhattacharyya, D., Butterfield, D.A., *New Insights into Membrane Science and Technology: Polymeric and Biofunctional Membranes*, 2003.
- [5] Ho, W., Sirkar, K.K. (Eds.), *Membrane Handbook*. van Nostrand Reinhold, New York, 1992
- [6] McGregor, W.C., *Bioprocess Technology, Vol. 1: Membrane Separations in Biotechnology*, 1986
- [7] Mohr C. M., E.D.E., Leeper S. A., Charboneau B. L., *Membrane Applications and Research in Food Processing*. Noyes Data Corporation, Park Ridge, NJ, USA, 1989
- [8] Butterfield, D.A., *Biofunctional Membranes*, Plenum Press, New York, 1996
- [9] Tosa T., Mori T., Fuse N., Chibata I., *Studies on continuous enzyme reactions. I. Screening of carriers for preparation of water-insoluble aminoacylase*. *Enzymologia*. 1966, 31
- [10] Sheldon R.A., *Cross-linked enzyme aggregates (CLEAs): stable and recyclable biocatalysts*. *Biochem Soc*. 2007, 35
- [11] Brena, B., Gonzàles-Pombo, P., Batista-Viera, F., *Immobilization of Enzymes: A Literature Survey*, in J.M. Guisan (Ed.), *Immobilization of Enzymes and Cells*, Vol. 1051 of the series *Methods in Molecular Biology*, Humana Press, Springer, 2013, Chapter 2
- [12] Jochems P., Satyawali, Y., Dielsa, L., Dejonghea, W., *Enzyme immobilization on/in polymeric membranes: status, challenges and perspectives in biocatalytic membrane reactors (BMRs)*, *Green Chem.*, 2011, 13

- [13] Giorno, L., Drioli, E., Biocatalytic membrane reactors: applications and perspectives, *Trends in Biotechnology* 2000, 18
- [14] Brady, D., Jordaan, J., Advances in enzyme immobilization, *J. Biotechnol Lett*, 2009, 31
- [15] Haupt, K., Bueno, S. M. A., Affinity membranes, in Ian D. Wilson and Colin F. Poole (Eds.), *Handbook on methods and instrumentation in separation science*, Volume 1, Academic Press, 2000
- [16] Riggin, A., Regnier, F.E., Sportsman, J.R., Quantification of antibodies to human growth hormone by high-performance protein G affinity chromatography with fluorescence detection. *Anal Chem* 1991, 63
- [17] Voet, D., Pratt, C.W., Voet, J.G., *Fundamentals of Biochemistry, Take Note!*, 2nd Edition, 2004
- [18] Varilova, T., Madera, M., Pacakova, V., Stulik, K., Separation media in affinity chromatography of proteins - a critical review. *Current Proteomics*, 2006, 3
- [19] Zou, H., Luo, Q., Zhou D., Affinity membrane chromatography for the analysis and purification of proteins, *J. Biochem. Biophys. Methods* 2001, 49
- [20] Charcosset C., Purification of proteins by membrane chromatography. *Journal of Chemical Technology and Biotechnology*, 1998, 71
- [21] Janata J., Bezegh, A., Chemical sensors, *Anal.Chem.*, 1988, 60
- [22] Lindner E., Gyurcsanyi, R. E., Buck, R. P., Membranes in Electrochemical Chemistry: Membrane-based Chemical and Biosensors, in P. Somasundaran (Ed.), *Encyclopedia of Surface and Colloid Science*, Volume 5, 2006, Taylor and Francis, NY, London
- [23] John I. N., Stanley M. K., The Interface in Biosensing: Improving Selectivity and Sensitivity, in Helburn, R., et al. (Eds.) *Interfaces and Interphases in Analytical Chemistry*, Chapter 11, 2011, ACS Symposium Series, American Chemical Society, Washington, DC

- [24] Mo Y., Fei T., Nanoporous membranes for biosensing applications, *Nano LIFE*, 2012, 2
- [25] Naqvi A., Gandhi R.P., Nahar P., Introduction of functional groups onto PP and PE surfaces for immobilization of enzymes, *Anal. Biochem.* 2002, 306
- [26] Liu Z.M., Xu Z.K., Wang J.Q., Yang Q., Wu J., Seta P., Surface modification of microporous polypropylene membranes by the grafting of poly ( $\gamma$ -stearyl-l-glutamate), *Eur. Polym. J.* 2003, 39
- [27] Beeskow T.C., Kusharyoto W., Anspach F.B., Kroner K.H., Deckwer W.D., Surface modification of microporous polyamide membranes with hydroxyethyl cellulose and their application as affinity membranes, *J. Chromatogr. A* 1995, 715
- [28] Beeskow T., Kroner K.H., Anspach F. B., Nylon-Based Affinity Membranes: Impacts of Surface Modification on Protein Adsorption, *J. Colloid Interf. Sci.*, 1997, 196
- [29] Klein E., Eichholz E., Yeager D.H., Affinity membranes prepared from hydrophobic coatings on microporous polysulfone hollow fibers, *J. Membr. Sci.*, 1994, 90
- [30] Lagoa R., Murtinho D., Gil M.H., Membranes of Cellulose Derivatives as Supports for Immobilization of Enzymes, in S.H. Imam, R.V. Greene, B.R. Zaidi (Eds.), *Biopolymers*, Vol. 723, ACS Symposium Series, 2009, Chapter 15
- [31] Sternberg R., Bindra D.S., Wilson G.S., Thévenot D.R., Covalent Enzyme Coupling on Cellulose Acetate Membranes for Glucose Sensor Development, *Anal. Chem.*, 1988, 60
- [32] Xu Z., Huang X., Wan L., Surface Engineering of Polymer Membranes. *Advanced Topics in Science and Technology in China*, 2009
- [33] Mackerle J., Coatings and surface modification technologies: A finite element bibliography (1995-2005), *Model Simul Mater SC*, 2005, 13
- [34] Klein, E. Eichholz, D.H. Yeager, Affinity membranes prepared from hydrophilic coatings on microporous polysulphone hollow fibers, *J. Membr. Sci.* 1994, 90

- [35] Charcosset C., Su Z., Karoor S., Daun G., Colton C., Protein A immunoaffinity hollow fiber membranes for immunoglobulin G purification: experimental characterization, *Biotechnol. Bioeng.* 1995, 48
- [36] Castilho L. R., Deckwer W.D., Birger F., Anspach F.B., Influence of matrix activation and polymer coating on the purification of human IgG with protein A affinity membranes *Journal of Membrane Science* 2000, 172
- [37] Kang G., Cao Y., Application and modification of polyvinylidene fluoride (PVDF) membranes – A review. *J. Membr. Sci.* 2014, 463
- [38] Goddard J.M., Hotchkiss J.H., Polymer surface modification for the attachment of bioactive compounds. *Prog. Polym. Sci.* 2007, 32
- [39] Nevell T.P., The mechanism of the oxidation of cellulose by periodate, *J. Text. Inst. Trans.* 1957, 48
- [40] Varma A.J., Kulkarni M.P., Oxidation of cellulose under controlled conditions, *Polym. Degrad. Stab.* 2002, 77
- [41] Liu Y.C., Suen S.Y., Huang C.W., ChangChien C.-C., Effects of spacer arm on penicillin G acylase purification using immobilized metal affinity membranes. *J. Membr. Sci.* 2005, 251
- [42] Bueno S.M.A., Haupt K., Vijayalakshmi M.A., Separation of immunoglobulin G from human serum by pseudobioaffinity chromatography using immobilized L-histidine in hollow fibre membranes. *Journal of Chromatography B*, 1995, 667
- [43] Stollner D., Scheller F.W., Warsinke A., Activation of cellulose membrane with 1,1 carbonyldiimidazole or 1-cyano-4-dimethylaminopyridinium tetrafluoroborate as a basis for the development of immunosensors, *Anal. Biochem.* 2001, 304
- [44] Klein, E., Affinity membranes: a 10-year review. *Journal of Membrane Science* 2000. 179
- [45] Bartling G.J., A Study of the Mechanism of Cyanogen Bromide Activation of Cellulose, *Biotechnology and Bioengineering* 1972, XIV

- [46] Barbosa O., Ortiz C., Berenguer-Murcia A., Torres R., Rodrigues R. C., Fernandez-Lafuente R., Glutaraldehyde in bio-catalysts design: a useful crosslinker and a versatile tool in enzyme immobilization, *RSC Adv.*, 2014, 4
- [47] Ruckenstein E., Li Z.F., Surface modification and functionalization through the self-assembled monolayer and graft polymerization. *Adv Colloid Interf Sci* 2005, 113
- [48] Ulman A., Formation and structure of self-assembled monolayers. *Chem Rev* 1996, 96
- [49] Ruckenstein E., Li Z.F., Surface modification and functionalization through the self-assembled monolayer and graft polymerization. *Advances in Colloid and Interface Science* 2005, 113
- [50] Lvov Y., Decher G., Mohwald H., Assembly, structural characterization, and thermal behavior of layer-by-layer deposited ultrathin films of poly(vinylsulfate) and poly(allylamine). *Langmuir* 1993, 9
- [51] Yoon H., Dell E. J. , Freyer J. L., Campos L. M., Woo-Dong Jang, Polymeric supramolecular assemblies based on multivalent ionic interactions for biomedical applications *Polymer* 2014, 55
- [52] Smuleac V., Butterfield D. A., Bhattacharyya D., Layer-by-Layer-Assembled Microfiltration Membranes for Biomolecule Immobilization and Enzymatic Catalysis *Langmuir* 2006, 22
- [53] Dinklage A., Klinger T., Marx G., Schweikhard L., *Plasma physics*, Springer, New York, 2005
- [54] Lane J.M., Hourston D.J., Surface treatments of polyolefins. *Prog Org Coat* 1993, 21
- [55] Situma C., Wang Y., Hupert M., Barany F., McCarley R.L., Soper S.A., Fabrication of DNA microarrays onto poly (methyl methacrylate) with ultraviolet patterning and microfluidics for the detection of low-abundant point mutations. *Anal Biochem* 2005, 340
- [56] Nahar P., Naqvi A., Basir S.F., Sunlight-mediated activation of an inert polymer surface for covalent immobilization of a protein. *Anal Biochem* 2004, 327

[57] Poncin-Epaillard F., Vrlic T., Debarnot D., Mozetic M., Coudreuse A., Legeay G., El Moualij B., Zorzi W., Surface Treatment of Polymeric Materials Controlling the Adhesion of Biomolecules, *J Funct Biomater*. 2012, 3

[58] Pujaria N.S., Vaidyab B.K., Bagalkotea S., Ponrathnama S., Neneb S., Poly(urethane methacrylate-co-glycidyl methacrylate)-supported-polypropylene biphasic membrane for lipase immobilization, *Journal of Membrane Science* Volume 2006, 285

[59] Nakanishi, K., Sakiyama, T., Kumada, Y., Imamura, K., Imanaka, H., Recent Advances in Controlled Immobilization of Proteins onto the Surface of the Solid Substrate and Its Possible Application to Proteomics, *Curr. Proteomics* 2008, 5

[60] Hermanson, G.T., *Bioconjugate techniques*, 2nd Ed., Academic Press, San. Diego, 1996

[61] Mateo C., Palomo J. M., Fernandez-Lorente G., Guisan J. M., Fernandez-Lafuente R., Improvement of enzyme activity, stability and selectivity via immobilization techniques, *Enzyme and Microbial Technology* 2007, 40

[62] Mohamada N. R., Haziqah Che Marzukia N., Buanga N. A., Huyopb F., Wahab R. A., An overview of technologies for immobilization of enzymes and surface analysis techniques for immobilized enzymes, *Biotechnology & Biotechnological Equipment*, 2015

[63] Datta S., Yamuna R. C., Rajaram R. S., Enzyme immobilization: an overview on techniques and support materials, *Biotech* 2013, 3

[64] Talbert J. N., Goddard J. M., Enzymes on material surfaces, *Colloids and Surfaces B: Biointerfaces* 2012, 93

[65] Nakanishi K., Sakiyama T., Imaura K., On the adsorption of proteins on solid surfaces, a common but very complicated phenomenon. *Journal of Bioscience and Bioengineering*, 2001

[66] Butterfield D. A., Bhattacharyya D., Daunert S., Bachas L., Catalytic biofunctional membranes containing site-specifically immobilized enzyme arrays: a review, *Journal of Membrane Science* 2001, 181

- [67] Lund M., Akesson T., Jonsson B., Enhanced protein adsorption due to charge regulation, *Langmuir* 2005, 21
- [68] Hamlin R.E., Dayton T.L., Johnson L.E., Johal M.S., A QCM study of the immobilization of beta-galactosidase on polyelectrolyte surfaces: Effect of the terminal polyion on enzymatic surface activity, *Langmuir* 2007, 23
- [69] Malinin A., Rakhnyanskaya A., Bacheva A., Yaroslavov A., Activity of an enzyme immobilized on polyelectrolyte multilayers, *Polym. Sci. Ser. A* 2011, 53
- [70] Brandon, C., Tooze, J., The building blocks. In *Introduction to Protein Structure*, 2nd Ed., Garland Publishing: New York, 1999
- [71] Latour R. A., *Biomaterials: Protein–Surface Interactions*, Encyclopedia of Biomaterials and Biomedical Engineering, Taylor & Francis, 2005
- [72] Rabe M., Verdes D., Seeger S., Understanding protein adsorption phenomena at solid surfaces, *Advances in Colloid and Interface Science* 2011, 162
- [73] Haynes C. A., Norde W., Globular proteins at solid/liquid interfaces, *Colloids and Surfaces B: Biointerfaces*, 1994, 2
- [74] Gunton J.D., Shirayev A., Pagan D.L., *Protein Condensation: Kinetic Pathways to Crystallization and Disease*, Cambridge Univ Press, Cambridge, UK, 2007
- [75] Mulheran P. A., Pellenc D., Bennett R. A., Green R. J., Sperrin M., Mechanisms and Dynamics of Protein Clustering on a Solid Surface, *Phys. Rev. Lett.* 2008, 100
- [76] Rabe M., Verdesa D., Seeger S., Surface-induced spreading phenomenon of protein clusters, *Soft Matter*, 2009, 5
- [77] Zhang J., Liu X. Y., Effect of protein–protein interactions on protein aggregation kinetics, *Journal of Chemical Physics* 2003, 119
- [78] Ugwu S. O., Apte S. P., *The Effect of Buffers on Protein Conformational Stability*, Pharmaceutical Technology, 2004

[79] Vendruscolo M., Dobson C. M., Chemical biology: More charges against aggregation, Nature 2007, 449



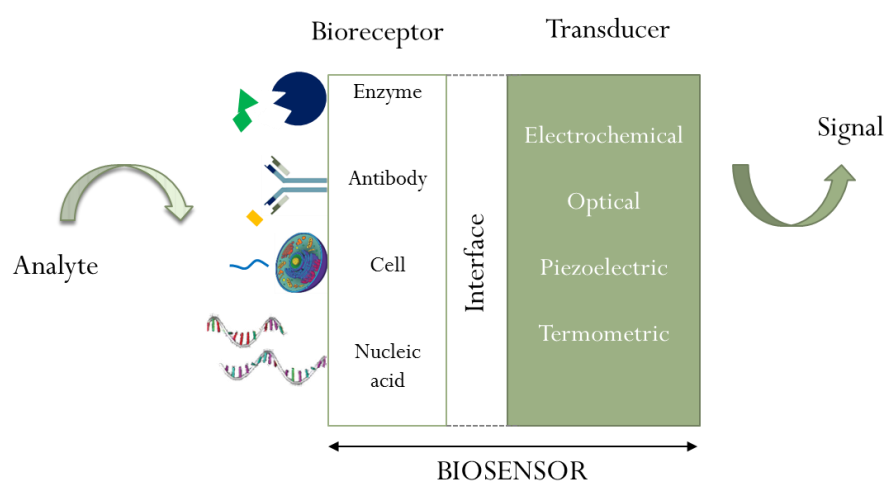
**Chapter 2**

**Membranes for biosensors development**

This chapter contains the analysis of recent literature on membranes application in bio-sensing field. It starts with a brief description of biosensors basic concepts. Then, different aspects of the use of membranes in biosensing are discussed, including the membrane functions and properties as well as the different membrane types and the incorporation or integration of these membranes into miniaturized systems with related advantages. Following, the transduction methods and systems that are commonly combined with membranes for signal transduction and detection are explained and a summary of the membrane-based biosensors application in different areas is given, concluding with a general consideration and the research work proposed in this research topic.

## 2.1 Biosensors basic concepts

A biosensor is an analytical device capable of providing specific quantitative or semi-quantitative analytical information, using a biological sensing element (bioreceptor) intimately associated with or integrated within a physico-chemical transducer [1]. The basic concept of operation of a biosensor is illustrated in figure 2.1. The bioreceptor, which is an immobilized biological element (i.e. enzyme, antibody, DNA probe, etc.), recognizes a specific analyte through a biocatalytic reaction or a specific binding and the transducer converts the result of this recognition into a usable signal, which can be quantified. Thus the bioreceptor is responsible for the selectivity of the sensor, it is very specific to the analyte to which it is sensitive.



**Figure 2.1** A schematic representation of a biosensor and working principle

Biosensors are generally classified in two ways according to either the basic principles of signal transduction or the bioreceptor (scheme 2.1).

According to the recognition properties of the bio-element, the two biosensor groups are: catalytic biosensors and affinity biosensors. Catalytic biosensors are based on biological catalyst such as enzymes, cells, microorganisms which promote a specific reaction with the analyte producing the species to be detected. Otherwise, affinity biosensors are based on biomolecules able to selectively and reversibly bind specific ligands (i.e. antibodies/antigens, nucleic acids) and the binding event is monitored.

Based on the transduction method, biosensors are classified into four main classes: 1) electrochemical, 2) optical, 3) piezoelectric and 4) thermometric. Each of these classes contains many different subclasses generating a great number of possible transduction methods. For example, the electrochemical biosensors, based on the parameter measured, can be further classified as amperometric, potentiometric, impedimetric.

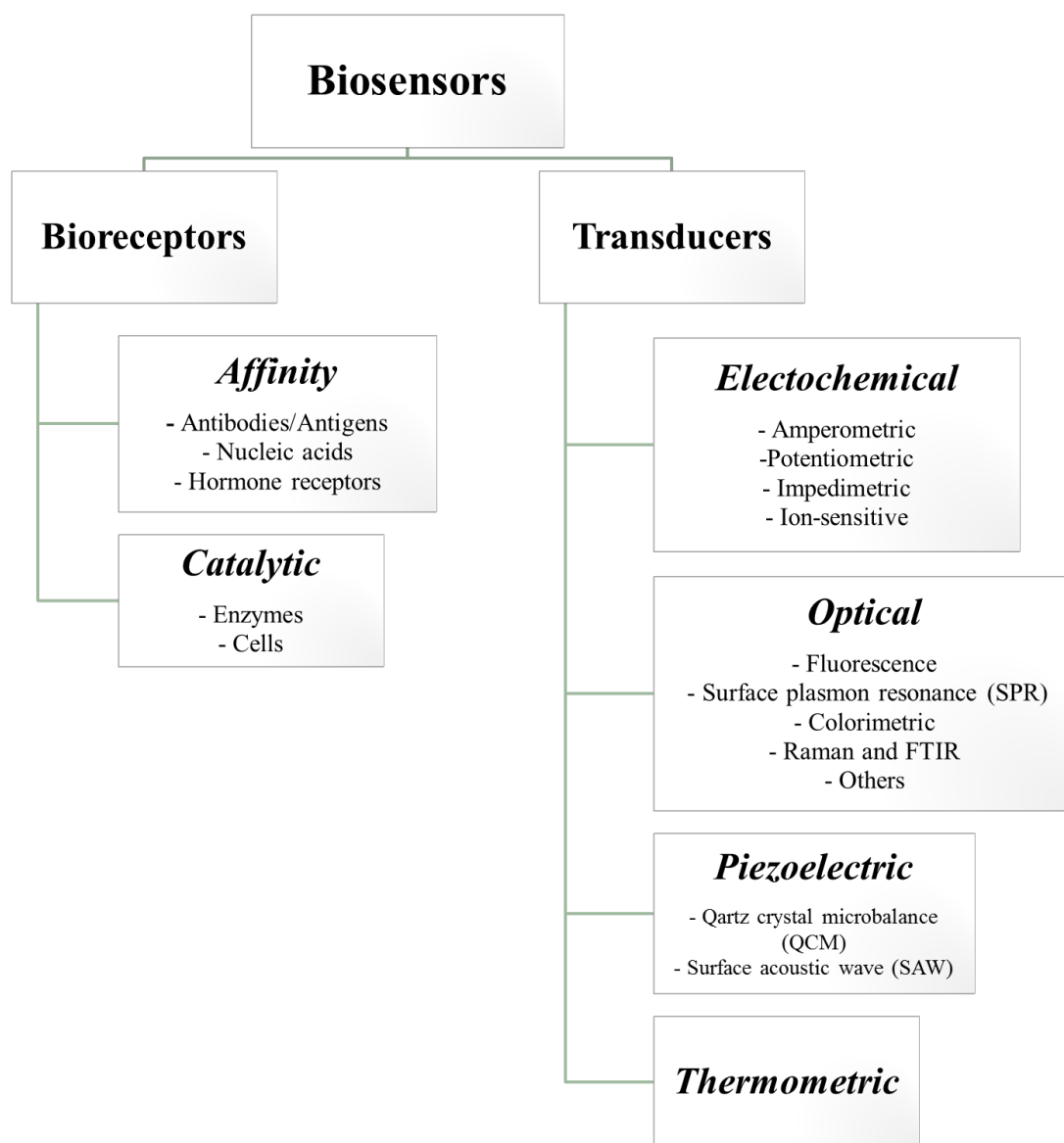
**Catalytic biosensors:** they are mostly represented by *enzymatic biosensors*. Enzymes were the first biological components used in biosensors and remain the most commonly used bio-recognition elements due to their specific binding capabilities as well as their catalytic activity. An enzyme-catalyzed reaction may generate a variety of measurable products including protons, electrons, light and heat that can be directly determined using one of the transduction methods mentioned above.

The most largely studied and commercially available enzymatic biosensors are those for measuring glucose in blood samples using glucose oxidase or glucose dehydrogenase for the monitoring of diabetes [2].

**Affinity biosensors:** they involve mainly *Immunosensors* and *DNA sensors*. *Immunosensors* make use of specific interactions between an antibody and an antigen. Antibodies are complex biomolecules with molecular recognition properties exhibiting very specific binding capabilities for specific structures (antigens). These properties of antibody are crucial to their usefulness in immunosensors where only the specific analyte of interest, the antigen, fits into the antibody binding site. The formation of antigen-antibody complex can be monitored by different transduction mechanisms based for example, either on the generation of an optical or electrochemical signal, or a mass change on the sensor surface. Immunosensors can be designed to detect both antibodies and antigens in biological fluids and also in other media, including food and the natural

environment [3]. The sensitivity and the stability of an immunosensor directly depend on the type of antibody used for the immunosensor design, the quantity of immobilized molecules and the method of immobilization that affects antibody activity and orientation on the sensing interface.

*DNA sensors* are based on the specific recognition process of nucleic acids consisting in the hybridization of two single stands having complementary bases sequences. The hybridization occurs between a known DNA sequence, called probe, and an unknown counterpart, the target. The duplex formation can be detected by using a hybridization indicator (i.e. a fluorescent label) or by following other changes occurred during the binding event. The probes can be DNA fragments synthesized by DNA amplification or oligonucleotide sequences having no natural analogue, named aptamers. DNA sensors have been used for monitoring DNA-ligand interactions, for the detection of DNA damage, determination of drug in blood, for toxins, etc. [4].



**Scheme 2.1** Schematic of biosensors classification

## 2.2 Membranes for biosensing

Membranes of different materials, porosity and geometry have been largely used in several medical and biological applications including biomolecules separation and sorting, analysis of single molecules, sensing of ions and proteins, as well as immunoisolation and drug delivery [5]. In biosensing application, the membrane technologies offer multiple advantages. The high surface area to volume ratio is one of the most important properties of nanostructured membranes. The increased pore surface is able to interact with

biomolecules trapped into the pores or flowing through the membrane providing a large and often highly reactive surface area, which enables more effective capture and detection of molecules on the sensing surface. In addition, compared with other nanostructures, such as nanotubes and nanowires, membranes allow to separate biomolecules based on their size, shape, charge and interactions with nanopores, increasing the selectivity of the sensor. They can be manufactured using various techniques with high control in pore size, pore size distribution, pore location, nano-architecture, nano-patterns and the overall physical and chemical properties. Besides, surface modification techniques can be used to improve biocompatibility, anti-biofouling capability, to promote/control the interaction with biomolecules.

Moreover, with the increasing interest on microfluidic and lab-on-a chip systems, membranes have been also easily integrated into microfabricated platforms for the “real-time” and cost-effective detection of target analyte [6].

### *2.2.1 Membrane properties and functions*

Membranes may have different functions in biosensing systems, acting or not as integral part of the transduction mechanism. They can be used as barrier structure between the sensor system (bioreceptor and transducer) and its environment. In this case, by exploiting the transport properties of membranes, the interfering species can be excluded from the sensor surface allowing the only access of the analyte to the bioreceptor and protecting the bioreceptor from the environment. Requirements such as the permeability and selectivity become important to permit an adequate flow of the analyte to the transducer and to prevent the flow of other active species, respectively [7]. Permselective membranes are generally used to design the front and interface of the biosensor. They are used to coat the electrode surface in the form of a single membrane layer or multilayered membranes with different transport properties. The mechanism of selective transport can be based on size-exclusion, charge-exclusion or both. The different species can be discriminated based on their molecular size by using a size-exclusion membrane that allows small molecules to pass through while preventing larger molecules to reach the sensor surface. Equally, charged interferences can be eliminated by using a membrane that has a charge similar to the species to be discriminated. Additional selectivity can be achieved by the use of multilayered systems that combine the properties of different membranes. Moreover, the permeability of such membrane can be tuned to meet specific

needs. Thus, the selectivity can be achieved by taking advantage of analyte properties (i.e. charge, size, shape) and the selection of a proper membrane.

In implantable biosensors, the protective function of the membrane play a crucial role on the overall sensitivity: both inner and outer membranes are used, either to immobilize the bioreceptor or eliminate interferences and to prevent bio-fouling or to govern the analyte diffusion, respectively [8].

Other biosensing systems involve the use of porous membranes for retaining the analyte and then increasing its local concentration, to improve the overall sensitivity [9].

Another important role of the membrane in biosensing systems is related to their use as immobilization matrix for the bioreceptor. The bioreceptor (i.e. enzyme, antibody, etc.) which ensure the molecular recognition of the analyte, can be immobilized in/on the membrane/surface and the membrane can be used as tool for bringing it in the immediate vicinity of the transducer or even, the bioreceptor can be embedded in a layer coating the active tip of the transducer [10]. The binding efficiency is mainly dependent on the surface properties of the membrane such as hydrophobicity, roughness, or the presence of reactive functional groups.

### *2.2.2 Membrane materials*

Both inorganic and polymeric membranes are used for the development of biosensors. Inorganic membranes are versatile, can be used at high temperatures and they are highly resistant to chemical attack. However, polymeric membranes are most commonly used in biosensors application because of their low cost and variability, a lot of polymeric materials are available allowing to obtain membranes with different barrier structure and surface properties.

#### **Inorganic membranes**

Inorganic membranes are made from oxides, ceramics and metals. At present, among the inorganic materials, nanoporous membranes with well-ordered pores such as anodic alumina and nanoporous silica receive the major attention for use in biosensor applications. Nanoporous alumina membrane, also known as anodic aluminum oxide (AAO), have been extensively used due to its excellent biocompatibility, non-conductivity, ease of functionalization and well-established fabrication process resulting in well-defined nanopores, small pore size and high pore density. Alumina membranes are also

commercially available. They have been used, for example, for nucleic acid detection by modifying the nanopores with covalently bound DNA probe and monitoring the variation of ionic conductivity in nanopores due to DNA hybridization determining the pore blocking to ionic flow [11].

In addition to aluminum oxide, silicon, gold and silver membranes have been used in several cases [12-14].

### **Polymeric membranes**

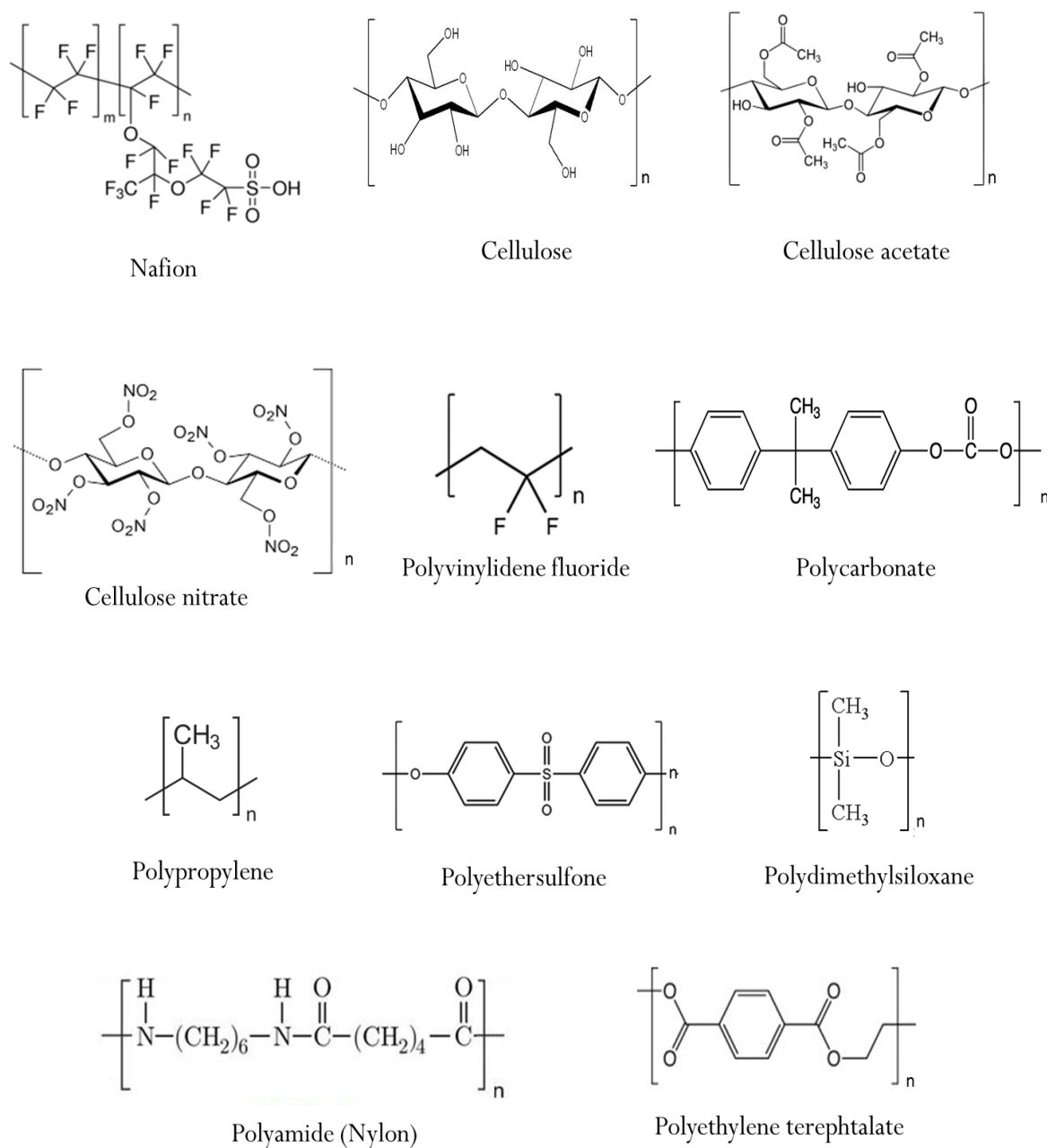
Since the development of the first biosensor [15], polymeric membranes have played an important role and continue to contribute to the advancement of even more complex and efficient systems.

Polymeric membranes have been used for various functions: structure support, inner and outer protective barrier, for the immobilization of the bio-recognition element, acting in some cases as integral part of the sensing process. The chemical structure of the commonly used polymeric materials for membrane preparation is illustrated in figure 4. The two earliest and most commonly used membranes in biosensing field are Nafion [16] and cellulose acetate [17]. Nafion is a fluorinated negatively charged polymer with both hydrophobic and hydrophilic properties, good biocompatibility, it is chemically inert, stable with temperature and limits the diffusion of small neutral or negatively charged interfering molecules. Due to the advantageous properties described, it has been extensively used in biosensor as coating material to reduce biofouling, also in vivo applications [18]. Most of the applications of Nafion membranes as outer protective barrier are referred to the construction of glucose biosensors [19], [20]. But recently, Nafion outer protective membranes have been also used in DNA based biosensors showing anti-fouling effect in different matrices [21].

Membranes of natural origin as cellulose and its derivatives are very suitable for biomedical applications. Cellulose acetate membranes are commonly used for protective function and for enhancing biocompatibility, for example, in electrochemical biosensors [17]. Thanks to its strong adsorption capacity, nitrocellulose membranes have been used as functional membranes in different biosensing systems. For example, for the realization of an enzyme-linked immuno-strip biosensor for the detection of *E. coli* [22]. Nitrocellulose membrane was also used in combination with magnetic bead for the detection of two different influenza A viruses [23], and again, as support for antibody immobilization for



the development of *E. coli* amperometric biosensor [24]. Other membranes used in biosensors were made with polyvinylidene fluoride (PVDF), polycarbonate (PC), polypropylene (PP), polyethylene terephthalate (PET), polyethersulfone (PES), polydimethylsiloxane (PDMS).



**Figure 2.2** Chemical structure of commonly used polymeric membrane materials

### *2.2.3 Membranes integration with miniaturized systems*

One of the emerging needs in the biosensing field is the real-time and cost-effective detection of target analytes. The rapid development in the field of microfluidic has allowed the construction of even more sophisticated miniaturized bioanalytical devices that aim to integrate mixing, reaction, separation, and detection functions into miniaturized chips, for facilitating the automation of sample analysis, reducing the time and reagent consumption and limiting costs. Hence, a lot of the present research in the biosensing area focuses on the integration of these functions on microfluidic devices for real-time measurements. One of the innovative approaches adopted has been the integration of nanostructured membranes into these systems. Often, the membrane has been incorporated for biomolecular separation and sample pre-concentration.

The sample concentration before analysis offer multiple advantages to the sensor system: it enables detection of species present in very low concentration, such as DNA or proteins from biological systems, which can be significant for clinical diagnostic and improve the detection sensitivity and signal-to-noise ratio, enabling the use of more different detection techniques.

Membrane-based sample pre-concentration have been obtained by means of three main techniques: filtration, evaporation, and concentration polarization [25]. For example, Song S. et al. [26] performed an electrophoretic proteins concentration into microfluidic chip by using a nanoporous polymer membrane, increasing the local proteins concentration up to 104-fold in less than 2 min.

Over the years, considerable attention has been also devoted to ion-selective membranes for the development of new membrane-based microfluidic systems that integrate multiple functionalities comprising pumping, manipulation, pre-concentration and detection of biomolecules. It has been demonstrated that the ion concentration polarization phenomenon on ion-exchange membranes can be employed for separation, concentration, and detection of analytes on integrated membrane point-of-care diagnostic unit [27].

Nanostructured membranes have been also used for the development of microfluidic immunoassays and immunosensors [28]. Due to the porous structure, they have been extensively used in solid state immunoassay offering several advantages such as a greater surface area for the analysis, respect to nonporous plastic surfaces. Moreover, they can be

easily adapted for flow injection immunoassays playing different roles: they have been used as support for antibody immobilization retaining the target analyte [29] or they have been placed at the electrode participating in detection event [30] or even, they have been used as unit for analyte extraction and pre-concentration improving the sensitivity of the analysis [31]. Nitrocellulose and PVDF commercial membranes are commonly used in microfluidic assays [32]. Electrospun nanofibrous membranes have been used for the development of microfluidic immunoassays for HIV [33]. Alumina nanoporous membrane has been integrated into a PDMS based microfluidic immunosensor and it has been used for antibody immobilization and food pathogens detection [34].

Moreover, there are several approaches that can be used for integrating membranes into microfluidic chip. Commercial membranes comprised of polycarbonate, nitrocellulose and PVDF have been directly inserted and physically clamped into microfluidic chip [35]. Membranes have been also prepared in-situ, for example by condensation, interfacial polymerization [36], electrospinning [33]. Alternatively, the membranes have been prepared during the fabrication process of the chip or even, the membrane materials itself (i.e. PDMS and polyamide membranes) have been used to fabricate the chip [37].

### **2.3 Orientation of the bioreceptor**

The immobilization of the bioreceptor is one of the critical steps for the development of an efficient biosensor. The sensitivity, the selectivity and the stability of the biosensor are strongly influenced by the method chosen to link the bioreceptor to the sensor surface. Indeed, it directly affects the bioreceptor orientation, loading, mobility, stability, structure and biological activity.

The most used immobilization strategies are those described in chapter 1: adsorption, entrapment, covalent binding, affinity, crosslinking or a combination of them, also making use of spacers and linkers to help minimize steric hindrances between the biomolecule and the surface.

The above mentioned immobilization techniques can be grouped into two main classes: random (adsorption, entrapment, covalent binding, crosslinking) and oriented immobilization (affinity immobilization and covalent site-specific). Compared to the random immobilization, the oriented immobilization is more specific, it generally provides a homogeneous and reproducible bioreceptor layer with a properly orientation and enhanced activity. Several studies published in recent years show that the oriented

---

immobilization of the bio-active element improves the performances of a biosensor [38]. The two types of oriented immobilization are the affinity immobilization and the covalent-site specific immobilization.

### **Affinity immobilization**

The affinity immobilization is a type of bio-specific adsorption that exploits the selectivity of specific interactions that exists in nature. It is based on complementary interactions between biomolecules such as antibodies and antigens, nucleic acids and nucleic acid-binding proteins, avidin and biotin, etc., giving a relatively strong, highly specific and oriented protein immobilization. The procedure is based on the pre-bio/functionalization of the membrane with the affinity capture reagent that is then used for the site-specific immobilization of the target protein (the bioreceptor). This procedure, sometimes, may require the protein modification/engineering for the conjugation with affinity pair or tag.

One advantage/disadvantage of the affinity immobilization is the possibility of surface regeneration by using chemical treatment, pH change, ionic strength or heat treatment. For some applications this can be considered an advantage as it enables the surface reuse. For other applications, it may represent a limit, thus the oriented affinity immobilization can be followed by a covalent linkage.

The most common affinity interactions are: avidin/streptavidin-biotin, protein A/G-antibody, polyhistidine-metal ions, DNA-mediated and aptamers.

The avidin/streptavidin-biotin is one of the strongest non-covalent affinity binding, almost insensitive to pH, temperature, organic solvents and other denaturing agents [39]. Avidin is a tetrameric glycoprotein that can bind up to four molecules of biotin. Biotin is a small molecule normally used in conjugation with the target protein, due to its small size it does not affect protein functionality or conformation. Alternatively to avidin or streptavidin, engineered proteins such as neutravidin, are also available with highly specificity of binding to biotin, but lower stability to pH changes. Avidin and streptavidin have been attached to different surfaces by either physical adsorption or covalent binding [40] for the subsequent immobilization of biotinylated proteins.

Protein A and protein G are widely used for antibody (IgG) oriented immobilization. They have been extensively used for application in affinity chromatography for antibody purification [41], but their use in immunosensors design is increasing [42]. These proteins specifically interact with the Fc constant region of IgGs, thus the Fab variable region

remains well accessible for antigen binding. Protein G has three IgG binding domains, while protein A has five IgG binding domains. Respect to protein A, the protein G has a wider antibody binding range of IgG class and in general, IgG's have a higher affinity for protein-G than for protein-A. Both proteins have been attached to membranes by physical adsorption and covalent binding. The protein A/G-antibody complex can be dissociated by using acidic or basic treatments and the surface can be reused for further applications.

Other affinity interactions used for the site-specific immobilization of the bioreceptor are based on the protein engineering with affinity tag to the C- or N- terminus, such as polyhistidine, to have segment that specifically chelates metal ions (i.e. Ni<sup>2+</sup>) [38]. The interaction is reversible upon addition of competitive ligands or metal chelators.

### **Site-specific covalent immobilization**

The site-specific covalent immobilization allows the proteins attachment in a stable, definite and controlled manner on the sensor surface. The process is based on the introduction of a single chemical group or a sequence, in a specific location of the protein which will then react with a complementary group previously introduced into the surface. Ideally, the functional group should not cross-react with endogenous amino acids and its position should not affect the conformation of the target-binding site [38]. The reaction between the functional groups should be chemoselective and should work under physiological conditions (i.e. aqueous buffer and neutral pH) to avoid protein denaturation. This type of modification can be obtained by means of both chemical and enzymatic reactions [43]. The most used chemical reactions are the so-called 'click' reactions such as the copper catalyzed azide-alkyne cycloadditions, the Staudinger-ligations, the Diels-Alder cycloadditions, the thiol-ene additions, and the oxime formation [44].

## **2.4 Transduction mechanisms and systems**

The transduction is the process by which the biochemical interaction between the bioreceptor and the target molecule is converted into observable output signal, whose intensity is proportional to the analyte concentration. The bio-recognition processes, affinity recognition and catalytic recognition, offer different methods of detection. The most used detection methods in membrane-based biosensors are electrochemical and optical. Each detection mechanism differs in the design of the device, method of fabrication and the application area. Also, an increasing interest is devoted to the

miniaturization of the systems and the improvement of the portability. Compared to optical detection, the electrochemical methods are less sensitive, but they are more prone to miniaturization.

#### *2.4.1 Electrochemical detection*

In electrochemical biosensors, the biochemical interaction between the immobilized bioreceptor and the target molecule results in production or consumption of ions or electrons, affecting the electrical conditions of the system, for example the membrane electrical resistance [45] or the membrane potential. Thus, the membrane can be directly involved in the transduction process or, in other systems, it may act as physical support or barrier structure.

Based on the type of signal measured, the electrochemical detection techniques can be further classified into amperometric, potentiometric and impedimetric.

#### **Amperometric**

Amperometric methods are based on the measurement of the current resulting from the electrochemical oxidation or reduction of an electroactive specie, by maintaining a constant potential at a working electrode (generally made of platinum, gold or carbon) with respect to a reference electrode (generally made of Ag/AgCl) in an electrochemical cell. The current is then related to the concentration of the analyte present. Amperometric biosensors make use of redox enzymes (enzymes that catalyze reactions that produce or consume electrons), such as oxidases, dehydrogenases and peroxidases that either consume oxygen, or produce hydrogen peroxide, or produce (indirectly) the reduced form of NAD(P), during the course of the catalytic reaction with the substrate of interest [46]. The first enzyme-based biosensor was developed in 1962 by Clark and Lyons for glucose monitoring, by entrapping the enzyme glucose oxidase (GOX) over an oxygen electrode via a semipermeable dialysis membrane. Today, most *in vivo* and *ex vivo* glucose biosensors present a negatively charged inner cellulose membrane to decrease the interfering effect of electroactive species, such as ascorbate or ureate, and an outer barrier membrane to control the substrate diffusion and to avoid the access of high molecular weight interferences to the electrode [47],[48]. The membrane may act also as matrix for the enzyme immobilization to the electrode.

Enzymes immobilized membranes have been largely used for the construction of other amperometric biosensors. For example, the enzyme urease was immobilized on acrylonitrile (AN) copolymer membrane for urea detection. The enzyme-immobilized membrane was attached to a Pt working electrode with the non-selective side facing the surface of the electrode, then it was placed in an electrochemical cell and a potential was applied to the working electrode and the electrochemical current was awaited to become stationary. The addition of the urea substrate into the cell resulted into a current change that was recorded [49].

In another example, choline oxidase (ChOx) was immobilized by entrapment in a hybrid mesoporous alumina membrane for choline detection. The sensor system consisted of three electrodes, an Ag/AgCl reference electrode, a Pt auxiliary electrode, and a Pt working electrode coated with the enzyme-immobilized membrane. After injection of the substrate the resulting current from the generation of hydrogen peroxide was measured [50].

In labeled-detection systems, such as sandwich-type immunosensors, enzyme-labeled antibodies are generally used to obtain an electrochemical response after target antigen binding to the capture antibody. For example, Hamid et. al [29] developed a flow-through immunosensor system equipped with an immunofiltration membrane where a sandwich immunoassay was employed to electrochemically detect E. coli cells. The amperometric immunosensor consisted of an antibody-coupled membrane resting on a carbon working electrode, an Ag/AgCl reference electrode and a carbon counter electrode. The solution containing the E. Coli cells was allowed to flow through the membrane, then a peroxidase-conjugated second antibody was captured on the membrane surface and the enzyme activity was measured electrochemically.

### **Potentiometric**

Potentiometric methods consist on the measurement of a potential difference between two electrodes, a working and a reference electrode, which accumulate during the recognition process in an electrochemical cell when zero or no significant current flows through the electrode, i.e. in equilibrium conditions [51]. The dominant part of potentiometric biosensors consist of ion-selective electrodes (ISEs) that are based on ion-selective membranes used with ion-exchanger or ionophore (plasticized PVC is the most popular membrane material). In an electrochemical cell, the ion-selective membrane separates an inner reference solution and an outer sample solution of different ionic activities and the

potential developed at the membrane is the result of either an ion exchange process or an ion transport process occurring at each interface between the membrane and solution. The potential developed is proportional to the logarithms of the concentration of the active species, measured in relation to a reference electrode. The membrane establishes the preference with which the sensor responds to the analyte even in the presence of others interfering ions, thus giving the selectivity of the sensor. A typical potentiometric biosensor, such as for urea detection, employ an enzyme (urease) that catalyze the transformation of the neutral analyte (urea) in to a ionic product ( $\text{NH}_4^+$ ) that the electrode (ISE) is designed to sense [52].

More recent biosensor designs are based on the modulation of ion fluxes at the membrane/sample interface caused by a biorecognition event that take place at or near the membrane surface [53].

Recently, Ozdemir et al. [54] developed a potentiometric biosensor for the detection of antigen-antibody interaction at an ion-selective membrane surface for point-of-care (POC) diagnostics. A PVC cation responsive membrane electrode was prepared and a steady-state flux of a quaternary ammonium marker ion across the membrane was established. The mechanism of action of the sensor was based on the disturbance of the marker ion flux as a result of the target molecule binding on the membrane surface. As the membrane was sensitive to the marker ion that leached out from an internal solution to the sample side where the antigen was present, the binding of the antigen to the antibody (immobilized on the membrane surface) disturbed the flux of the marker ion, resulting in an increase of its surface concentration and hence of the measured potential.

Pawlak et al. [55] developed a new electrochemical sensor for Concanavalin A based on blocking the surface of plasticized PVC membranes modified with D-mannose. The interaction of D-mannose with Concanavalin A at the surface perturbed the flux of a marker ion for which the ion-selective membrane was responsive, and this resulted in a change in the electrochemical signal.

Shishkanova et al. [56] developed a potentiometric biosensor based on PVC membrane ion-selective electrode modified with single-stranded oligonucleotides for the detection of hybridization events. The hybridization process, between the complementary single-stranded (ss) oligonucleotides, induced an ion concentration redistribution at the phase boundary PVC membrane/solution that was detected by potentiometric methods.



### Impedimetric

Impedimetric methods are based on the measurement of the impedance change caused by binding of targets to bioreceptors immobilized onto the electrode surface. Impedimetric detection is mostly used for affinity biosensors to monitor immunological binding events such as antibody–antigen binding or hybridization processes. When the bio-recognition event occurs, the electrode is coated with a blocking layer resulting in increasing of electron transfer resistance [57]. The most popular method is electrochemical impedance spectroscopy (EIS).

Membranes with well-defined nanopores such as aluminum anodized membranes are commonly used for immobilizing bioreceptors to construct impedance biosensors. These membranes can be fabricated with nanopore sizes comparable to the size of small biomolecules such as DNA, thus can be used to detect DNA molecules by monitoring the ion conductivity change in the nanopores. The sensing mechanism basically relies on the blocking of the nanochannels of a membrane modified electrode upon the formation of an affinity complex at the nanopore membrane.

For example, nanoporous  $\text{Al}_2\text{O}_3$  membrane with covalently linked DNA has been used to detect target DNA by monitoring the increase in impedance at the electrode upon DNA hybridization, which resulted from blocking the channels to ionic flow. A platinum working electrode was placed in close contact with the tested side of the membrane, while a screen counter electrode was in contact with the opposite side and the  $\text{Fe}(\text{CN})_6^{4-/3-}$  and  $\text{Ru}(\text{NH}_3)_6^{2+/3+}$  redox pairs were used to probe the efficiency of ion blockage [58]. In another study, nanoporous alumina membranes with 100 nm pore sizes were used to develop a membrane-based impedimetric biosensor for pathogenic bacteria detection. The measurement system consisted of the antibody-coupled membrane, which divided the reaction space into an upper and a lower chamber, and the electrodes. The binding of target bacteria on the surface of the antibody-coupled membrane affected the flow of ions through the membrane in concentration dependent manner, which was monitored by impedance spectra and analyzed by normalized impedance change [59].

Bacterial cells have been also detected in a similar manner. The bacteria were captured by the antibody-immobilized membrane, resulting in the pores blockage, and thus the flow of the electrolyte, leading to an increase in the impedance of the sensor [60].

In a different example, conducting polymer electrode was fabricated by chemical deposition of polypyrrole onto the surface of a microporous polycarbonate membrane to detect Salmonella-infecting phage. Salmonella host cells were absorbed onto the surface of the film and reacted with infecting bacteriophage. The bacteriophage mediated host cell lysis resulted in electrochemical changes in the supporting conducting polymer film which was detected using impedance spectroscopy [61].

#### *2.4.2 Optical detection*

Optical methods are widely used in biosensors as they are characterized by a high sensitivity and the possibility of using various spectroscopic techniques. Most of the optical detections are based on the measurement of luminescence, fluorescence, color changes, by the measurement of absorbance, reflectance or fluorescence emissions. Moreover, the use of methods such as surface enhanced Raman spectroscopy, and interferometry is also common [13].

In most cases the detection mechanism involve the use of label molecules such as dyes or fluorescent markers that emit light at specific wavelengths, or enzymes that catalyze colorimetric reactions. For example, liposomes with entrapped dye were conjugated to DNA probes and were used as labels to optically detect pathogen mRNA in a sandwich-hybridization assay format. The DNA probes were immobilized on a polyetersulfone membrane and used for hybridization with the target sequences. Then, the target sequences hybridized to a second liposome-conjugated DNA probe and the amount of liposomes captured in the detection zone was quantified with a reflectometer [62]. In a different system, Horseradish peroxidase (HRP) enzyme was used as label for the colorimetric detection of *E. coli*. A capture antibody was immobilized on the detection zone (nitrocellulose membrane) of an immuno-strip, then the HRP-conjugated second antibody was used to bind to the captured pathogen and the addition of the tetramethylbenzidine substrate allowed the colorimetric reaction to take place and the optical detection [22].

Another way to produce a visual color change is through the attachment of gold or carbon nanoparticles to sensing molecules [63].

The use of fluorescent dyes is also commonly practiced for optical detection. For example, liposomes filled with fluorescent dye were used as labels to antibodies for the detection of antigens. In this case, an integrated microfluidic system was developed combining sample pre-concentration and liposome-based fluorescent detection and signal amplification. The

fluorescent dye-liposomes conjugated with the antibody were mixed with the antigens to form the antigen-liposome complexes and then they were electrokinetically concentrated at a nanoporous membrane by applying a potential across the membrane. The concentrated complexes were eluted to a detection region where captured liposomes were lysed to release fluorescent dye molecules that were then quantified using image processing [64].

In a different example, antibodies were conjugated with CdSe/ZnS quantum dots (QDs) that were used as fluorescent label for the detection of *Salmonella typhi*. The biosensor design was based on the traditional immunoreaction between antibodies and antigens. A capture antibody was immobilized on porous PC membrane, and then the membrane with the captured bacteria was incubated with antibody-conjugated QDs for the formation of sandwich complex and fluorescent detection [65].

## 2.5 Applications of membranes in biosensors

The increased surface area together with the properties of selective barrier and the possibility of integration with both electrochemical and optical detection methods, allowed the use of nanostructured membranes in numerous biosensing applications, such as glucose detection, nucleic acid detection, bacteria and virus detection for either diagnostics or environmental and food analysis. The integration of nanostructured membranes in biosensors design has different advantages in terms of sensitivity, response time and lower detection limits. Table 3.1 summarizes various applications of membranes for biosensing comprising the membrane sensor types, the detection methods, the limits and time of detection.

**Table 2.1** Some applications of membrane biosensors

Biosensor application	Analyte	Membrane biosensor	Detection method	Detection limit	Detection time	Ref.
Bacteria detection	E.coli DNA sequence	Alumina membrane with immobilized DNA probe	Impedimetric	0.5 nM	-	[66]
	B. anthracis	Polyethersulfo	Optical (dye	1 nM	4 h	[62]

	mRNA sequence	ne membrane with immobilized DNA probe	labels)			
	Salmonella typhi	Polycarbonate membrane with immobilized antibody	Optical (fluorescent labels)	100 cells/ml	2.5 h	[65]
	S. aureus	Alumina membrane with immobilized antibody integrated in microfluidic chip	Impedimetric	10 <sup>2</sup> CFU/ml	2 h	[34]
	E.coli cells	Nylon immunofilter membrane with immobilized anti-E.coli antibody	Amperometric (enzyme-labeled)	100 cells/ml	30 min	[29]
			Optical (fluorescent labels)	2.3 CFU/ml	30 min	[67]
		Alumina membrane with immobilized antibody	Impedimetric	22 CFU/ml	90 min	[68]
Virus detection	Hepatitis B antigen	Nylon immunofilter membrane with immobilized antibody	Optical (fluorescent labels)	5 ng/mL	30 min	[67]
	Dangue	Polyethersulfo	Optical (dye	50	25 min	[69]

	virus RNA	ne membrane strip with immobilized capture DNA probes	labels)	molecules for the serotype 2		
	West Nile viral proteins and particles	Alumina membrane with immobilized antibody	Impedimetric	4 pg/ml proteins, 2 viral particles per 100 ml	30 min	[30]
Cancer biomarker detection	CA15-3 glycoprotein	Nanoporous alumina filter membrane with immobilized anti CA15-3 antibody	Voltammetric	52 U/ml	-	[70]
Cholesterol detection	Cholesterol	Silicic sol-gel membrane with immobilized cholesterol oxidase	Amperometric	$1.2 \times 10^{-7}$ M	-	[71]
		Cholesterol oxidase/ polypyrrole membrane	Amperometric	$6 \times 10^{-7}$ M	-	[72]
Glucose detection	Glucose	Nylon nanofibrous membrane with immobilized glucose oxidase	Amperometric	$6 \times 10^{-6}$ M	-	[73]
		Nanoporous ZrO <sub>2</sub> /Chitosan	Amperometric	$1.0 \times 10^{-5}$ M	10 s response	[74]

		composite film with immobilized glucose oxidase and covered with Nafion film			time	
Hemoglobin detection	HbA1c	Cellulose dialysis membrane with immobilized glycated pentapeptide	Optical (GOx-labeled secondary antibody)	-	-	[75]
Proteins detection	Ovalbumin (OVA)	Cellulose membrane with immobilized anti-OVA antibody	Optical (Colloidal-gold-labeled antibodies)	-	-	[76]

## 2.6 Concluding remarks and advancements

From the literature analysis the following observations can be made:

- There is an increasing use of membranes for the development of biosensors in a wide range of applications including diagnostics, environmental and food analysis. The main advantages of using membranes to develop biosensors are the high surface area-to-volume ratio that, compared to flat surfaces, enables the immobilization of enhanced quantity of bioreceptor (that results in an increased surface reaction and capturing area), and the ability to selectively separate molecules based on different mechanisms. Therefore, the membranes have been directly involved in the transduction process or/and they have been used as physical support or barrier structure, and even they have been used to filter or concentrate the target analyte. The combination of these membranes with realizable detection

techniques such as electrochemical and optical detection methods, allowed the development of detection systems with the advantages of rapid response, high sensitivity, and low detection limits. Moreover, they have been incorporated into miniaturized systems that integrate multiple functions for the real-time and cost-effective detection of analytes.

- In this research work, it has been developed immuno-affinity membranes with immobilized specific antibody for immunosensor applications. In particular, the membranes developed were used for the selective capture and recognition of a targeted analyte as described in chapter 4. Moreover, one of these membranes was integrated with an electrochemical detection system for the concentration of the analyte, in order to improve the detection sensitivity.

---

**References**

- [1] Thévenota D. R., Tothb K., Durstc R. A., Wilsond G. S., Electrochemical biosensors: recommended definitions and classifications, *Biosens. Bioelectro.*, 2001, 16
- [2] Yoo E.H. and Lee S.Y., *Glucose Biosensors: An Overview of Use in Clinical Practice*, Sensors, 2010, 10
- [3] Ricci F., Volpe G., Micheli L., Palleschi G., A review on novel developments and applications of immunosensors in food analysis, *Anal. Chim. Acta*, 2007, 605
- [4] Diculescu, V.C., Paquim, A.M. C., Brett, A. M. O., Electrochemical DNA Sensors for Detection of DNA Damage, *Sensors*, 2005, 5
- [5] Adiga, S. P., Jin, C., Curtiss, L. A., M. R., N. A., Narayan, R. J., Nanoporous membranes for medical and biological applications, *WIREs Nanomed. Nanobiotechnol.*, 2009, 1
- [6] Prasad, S., Kunduru, V., Yadav, Y., Bothar, M., Muthukumar, S., *Microfluidic Devices in Nanotechnology: Applications*, ed. Challa S. Kumar, Chapter 2 “Nanoporous membrane-based microfluidic biosensors” (John Wiley & Sons, Inc), 2010
- [7] Davies, M.L., Hamilton, C.J., Murphy, S.M., Tighe, B.J., Polymer membranes in clinical sensors, *Biomaterials*, 1992, 13
- [8] Vaddirajua, S., Tomazosb, I., Burgessc, D. J., Jaing, F. C., Papadimitrakopoulos F., Emerging synergy between nanotechnology and implantable biosensors: A review, *Biosens. Bioelectro.*, 2010, 25
- [9] Lee, G. U., Yanavich, C., Nanoporous membrane immunosensor, US Patent, 2004
- [10] Coulet, P.R., Polymeric membranes and coupled enzymes in the design of biosensors, *J. Membrane Sci.*, 1992, 68
- [11] Vlassiok, I., Takmakov, P., Smirnov, S., Sensing DNA Hybridization via Ionic Conductance through a Nanoporous Electrode, *Langmuir*, 2005, 21



- 
- [12] Desai, T. A., Hansfordb, D. J., Leonia, L., Essenpreisc, M., Ferrari M., Nanoporous anti-fouling silicon membranes for biosensor applications, *Biosens. Bioelectro.*, 2000, 15
- [13] Wigginton, K.R. and Vikesland, P.J., Gold-coated polycarbonate membrane filter for pathogen concentration and sers-based detection, *Analyst*, 2010, 135
- [14] Zhanga, L., Wanga, Y., Chenb, M., Luoa, Y., Denga, K., Chena, D., Fua W., A new system for the amplification of biological signals: RecA and complimentary single strand DNA probes on a leaky surface acoustic wave biosensor, *Biosens. Bioelectro.*, 2014, 60
- [15] Clark L.C., Lyons C., Electrode systems for monitoring in cardiovascular surgery, *Ann N Y Acad. Sci.*, 1962, 102
- [16] Wirguin, C. H., Recent advances in perfluorinated ionomer membranes: structure, properties and applications, *J. Membrane Sci.*, 1996, 120
- [17] Maines, A., Ashworth, D., Vadgama, P. Diffusion restricting outer membranes for greatly extended linearity measurements with glucose oxidase enzyme electrode, *Anal. Chim. Acta*, 1997, 323
- [18] Wisniewski, N., Reichert, M., Methods for reducing biosensor membrane biofouling, *Colloid Surface B*, 2000, 18
- [19] Yang, L., Ren, X., Tang, F., Zhang, L., A practical glucose biosensor based on Fe<sub>3</sub>O<sub>4</sub> nanoparticles and chitosan/nafion composite film, *Biosens. Bioelectro.*, 2009, 25
- [20] Mignani, A., Scavetta, E., Guadagnini, L., Tinelli, D., Comparative study of protective membranes for glucose biosensors based on electrodeposited hydrotalcites, *Sensor Actuat. B-Chem*, 2009, 136
- [21] Ambrozy, A., Hlavata, L., Labuda J. Protective membranes at electrochemical biosensors, *Acta Chim. Slov.*, 2013, 25
- [22] Park, S., Kim, H., Paek, S.H., Hong, J.W., Kim, Y.K., Enzyme-linked immuno-strip biosensor to detect *Escherichia coli* O157: H7, *Ultramicroscopy*, 2008, 108

- 
- [23] Hong, H.B., Krause, H.J., Song, K.B., Choi, C.J., Chung, M.A., Son, S.W., Offenhaeusser, A., Detection of two different influenza A viruses using a nitrocellulose membrane and a magnetic biosensor. *J. Immunol. Methods*, 2011, 365
- [24] Theegala, C.S., Small, D.D., Monroe, W.T., Oxygen electrode-based single antibody amperometric biosensor for qualitative detection of *E. coli* and bacteria in water, *J. Environ. Sci. Health Part A*, 2008, 43
- [25] Song, S., Singh, A.K., On-chip sample preconcentration for integrated microfluidic Analysis, *Anal Bioanal. Chem.*, 2006, 384
- [26] Song, S., Singh, A. K., Kirby, B. J., Electrophoretic Concentration of Proteins at Laser-Patterned Nanoporous Membranes in Microchips, *Anal. Chem.*, 2004, 76
- [27] Slouka, Z., Senapati, S., Chang, H.C., Microfluidic Systems with Ion-Selective Membranes, *Annu. Rev. Anal. Chem.*, 2014, 7
- [28] Hartwell, S.K., Grudpan, K., Flow based immuno/bioassay and trends in micro-immuno/biosensors, *Microfluidic Immunoassays*, *Microchim. Acta*, 2010, 169
- [29] Hamid, I. A., Ivnitiski, D., Atanasov, P., Wilkins, E., Highly sensitive flow-injection immunoassay system for rapid detection of bacteria, *Anal. Chim. Acta*, 1999, 399
- [30] Nguyen, B. T.T., Koh, G., Lim, H. S., Chua, A. J. S., Ng, M. M. L., Toh, C.S., Membrane-Based Electrochemical Nanobiosensor for the Detection of Virus, *Anal. Chem.*, 2009, 81
- [31] Tudorache, M. and Emnéus, J. Selective immuno-supported liquid membrane (ISLM) extraction enrichment and analysis of 2, 4, 6-trichlorophenol, *J. Membrane Sci.*, 2005, 256
- [32] Kim, D. and Herr, A. E. Protein immobilization techniques for microfluidic assays, *Biomicrofluidics* 2013, 7
- [33] Yang, D., Niu, X., Liu, Y., Wang, Y., Gu, X., Song, L., Zhao, R., Ma, L., Shao, Y. Jiang, X., Electrospun Nanofibrous Membranes: A Novel Solid Substrate for Microfluidic Immunoassays for HIV, *Adv. Mater.*, 2008, 20

- [34] Tan, F., Leungb, P.H.M., Liua, Z., Zhanga, Y., Xiaoa, L., Yea, We., Zhange, X., Yic, L., Yang M., A PDMS microfluidic impedance immunosensor for E. coli O157:H7 and Staphylococcus aureus detection via antibody-immobilized nanoporous membrane, *Sensor Actuat. B-Chem.*, 2011, 159
- [35] Gao, J., Xu, J., Locascio, L. E., Lee, C. S., Integrated Microfluidic System Enabling Protein Digestion, Peptide Separation, and Protein Identification, *Anal. Chem.*, 2001, 73
- [36] Hisamoto, H., Shimizu, Y., Uchiyama, K., Tokeshi, M., Kikutani, Y., Hibara, A., Kitamori, T. Chemicofunctional Membrane for Integrated Chemical Processes on a Microchip, *Anal. Chem.*, 2003, 75
- [37] Jong, J., Lammertink, R. G. H., Wesslinga, M., Membranes and microfluidics: a review, *Lab. Chip.*, 2006, 6
- [38] Redeker, E. S., Ta, D. T., Cortens, D., Billen, B., Guedens, W., Adriaensens, P., Protein Engineering For Directed Immobilization, *Bioconjugate Chem.*, 2013, 24
- [39] Smith, C. L., Milea, J. S., Nguyen, G. H., Immobilisation of DNA on Chips II 261, Ed. Wittmann, C., "Immobilization of Nucleic Acids Using Biotin-Strept(avidin) Systems" (Springer Berlin Heidelberg), 2005
- [40] Anzai, J., Osa, T. H. T., Biosensors and Their Applications, eds. Yang, V. C. and Ngo, T. T., "Avidin—Biotin Mediated Biosensors" (Springer, US), 2000
- [41] Zou, H. Luo, Qu., Zhou D., Affinity membrane chromatography for the analysis and purification of proteins, *J. Biochem. Bioph. Meth.*, 2001, 49
- [42] Makaraviciute, A., Ramanaviciene, A., Site-directed antibody immobilization techniques for immunosensors, *Biosens. Bioelectro.*, 2013, 50
- [43] Duckworth B. P., Xu J., Taton T. A., Guo A., Distefano M. D., Site-Specific, Covalent Attachment of Proteins to a Solid Surface, *Bioconjugate Chem.*, 2006, 17
- [44] Lutz, J.F., Copper-Free Azide–Alkyne Cycloadditions: New Insights and Perspectives, *Angew. Chem. Int. Ed.*, 2008, 47

- [45] McGraw, S. K., Alocilja, E., Senecal, K., Seneca, A. A Resistance Based Biosensor That Utilizes Conductive Microfibers for Microbial Pathogen Detection, *O. J. A. B.*, 2012, 1
- [46] Prodromidis, M. I. and Karayannis, M. I., Enzyme Based Amperometric Biosensors for Food Analysis, *Electroanalysis*, 2001, 14
- [47] Thévenota D. R., Tothb K., Durstc R. A., Wilsond G. S., Electrochemical biosensors: recommended definitions and classifications, *Biosens. Bioelectro.*, 2001, 16
- [48] Cordeiro, C.A., de Vriesa, M.G., Cremersa, T.I.F.H., Westerink, B.H.C., The role of surface availability in membrane-induced selectivity for amperometric enzyme-based biosensors, *Sensor Actuat. B-Chem.*, 2016, 223
- [49] Gabrovska, K., Ivanov, J., Vasileva, I., Dimova, N., Godjevargova, T., Immobilization of urease on nanostructured polymer membrane and preparation of urea amperometric biosensor, *Intern. J. Biol. Macromol.*, 2011, 48
- [50] Shimomuraa, T., Itohb, T., Sumiyaa, T., Mizukamib, F., Ono, M., Amperometric determination of choline with enzyme immobilized in a hybrid mesoporous membrane, *Talanta*, 2009, 78
- [51] Grieshaber, D., MacKenzie, R., Vörös, J., Reimhult, E., *Electrochemical Biosensors - Sensor Principles and Architectures*, *Sensors*, 2008, 8
- [52] Mascini, M., Guilbault, G. G., Urease coupled ammonia electrode for urea determination in blood serum, *Anal. Chem.*, 1977, 49
- [53] Pawlak, M. and Bakker, E., Chemical Modification of Polymer Ion-Selective Membrane Electrode Surfaces, *Electroanalysis*, 2014, 46
- [54] Ozdemir, M. S., Marczak, M., Bohets, H., Bonroy, K., Roymans, D., Stuyver, L., Vanhoutte, K., Pawla, M., Bakker E., A Label-Free Potentiometric Sensor Principle for the Detection of Antibody–Antigen Interactions, *Anal. Chem.*, 2013, 85
- [55] Pawlak, M., Mistlberger, G., Bakker, E., Concanavalin A electrochemical sensor based on the surface blocking principle at an ion-selective polymeric membrane,

- Microchim. Acta, 2015, 182 [56] Shishkanova, T.V., Volf, R., Krondak, M., Král, V., Functionalization of PVC membrane with ss oligonucleotides for a potentiometric biosensor, Biosens. Bioelectro., 2007, 22
- [57] Prodromidis, M. I., Impedimetric immunosensors—A review, Electrochim. Acta, 2010, 55
- [58] Vlassioux, I., Takmakov, P., Smirnov, S., Sensing DNA Hybridization via Ionic Conductance through a Nanoporous Electrode, Langmuir, 2005, 21
- [59] Joung, C. K., Kima, H. N., Lima, M. C., Jeonb, T. J., Kima, H. Y., Kim, Y. R., A nanoporous membrane-based impedimetric immunosensor for label-free detection of pathogenic bacteria in whole milk, Biosens. Bioelectro., 2013, 44
- [60] Tan, F., Foodborne Pathogens Detection with Nanoporous Anodic Aluminum Oxide Membrane Based Biosensor, Hong Kong Polytechnic University: Hong Kong, China, 2012
- [61] Dadarwal, R., Namvar, A., Thomas, D.F., Hall, J.C., Warriner, K., Organic conducting polymer electrode based sensors for detection of salmonella infecting bacteriophages. Mater. Sci. Eng. C, 2009, 29
- [62] Baeumner, A.J., Leonard, B., McElwee, J., Montagna, R.A., A rapid biosensor for viable B-anthraxis spores, Anal. Bioanal. Chem., 2004, 380
- [63] Chua, A.L., Yean, C.Y., Ravichandran, M., Lim, B., Lalitha, P., A rapid DNA biosensor for the molecular diagnosis of infectious disease, Biosens. Bioelectron., 2011, 26
- [64] Connelly, J.T., Kondapalli, S., Skoupi, M., Parker, J.S.L., Kirby, B.J., Baeumner, A.J., Micro-total analysis system for virus detection: Microfluidic pre-concentration coupled to liposome-based detection, Anal. Bioanal. Chem., 2012, 402
- [65] Jackeraya, R., Abida, C.K.V. Z., Singha, G., Jaina, S., Chattopadhyayaa, S., Saprab, S., Shrivastavc, T.G., Singh, H., Selective capturing and detection of Salmonella typhi on polycarbonate membrane using bioconjugated quantum dots, Talanta, 2011, 84

- [66] Wang, L., Li, Q., Hu, Z., Zhang, Y., Wu, C., Yang, M., Wang, P., A novel electrochemical biosensor based on dynamic polymerase-extending hybridization for *E. coli* O157:H7 DNA detection, *Talanta*, 2009, 78
- [67] Liu, Y., Brandon, R., Cate, M., Peng, X., Stony R., Johnson, M., Detection of Pathogens Using Luminescent CdSe/ZnS Dendron Nanocrystals and a Porous Membrane Immunofilter, *Anal. Chem.*, 2007, 79
- [68] Cheng, M. S., Lau, S. H., Chow, V. T., Toh, C. S., Membrane-Based Electrochemical Nanobiosensor for *Escherichia coli* Detection and Analysis of Cells Viability, *Environ. Sci. Technol.*, 2011, 45
- [69] Zaytseva, N. V., Montagna, R. A., Lee, E. M., Baeumner, A. J., Multi-analyte single-membrane biosensor for the serotype-specific detection of Dengue virus, *Anal. Bioanal. Chem.*, 2004, 380
- [70] Muñiz, A. E. and Merkoç, A., A Nanochannel/Nanoparticle-Based Filtering and Sensing Platform for Direct Detection of a Cancer Biomarker in Blood, *Small*, 2011, 7
- [71] Li, J., Peng, T., Pen, Y., A Cholesterol Biosensor Based on Entrapment of Cholesterol Oxidase in a Silicic Sol-Gel Matrix at a Prussian Blue Modified Electrode, *Electroanalysis*, 2003, 15
- [72] Li, J. P. and Gu, H. N., A Selective Cholesterol Biosensor Based on Composite Film Modified Electrode for Amperometric Detection, *J. Chin. Chem. Soc.*, 2006, 53
- [73] Scampicchio, M., Arecchia, A., Lawrence, N. S., Mannino, S., Nylon nanofibrous membrane for mediated glucose biosensing, *Sensor Actuat. B-Chem.*, 2010, 145
- [74] Yanga, Y., Yanga, H., Yanga, M., Li, Y., Shen, G., Yua, R., Amperometric glucose biosensor based on a surface treated nanoporous ZrO<sub>2</sub>/Chitosan composite film as immobilization matrix, *Anal. Chim. Acta*, 2004, 525
- [75] Stollner D., Scheller F.W., Warsinke A., Activation of cellulose membrane with 1,1 carbonyldiimidazole or 1-cyano-4-dimethylaminopyridinium tetrafluoroborate as a basis for the development of immunosensors, *Anal. Biochem.* 2001, 304

[76] Credou J., Volland H., Dano J., Berthelot T., A one-step and biocompatible cellulose functionalization for covalent antibody immobilization on immunoassay membranes, *J. Mater. Chem. B*, 2013, 1

## Chapter 3

**Development of bio-functionalized membranes: study of the relationship between proteins properties and membrane surface coverage**



This chapter deals with the development of bio-functionalized regenerated cellulose membranes by means of the covalent immobilization of biomolecules. In particular, the objective of this work was to study and to understand the effect of proteins bulk properties (concentration, size and aggregation phenomena) on the kinetics of immobilization, surface coverage and local distribution onto commercial regenerated cellulose membrane.

For this study, bovine serum albumin (BSA), enzyme lipase from *Candida rugosa*, recombinant Protein G and enzyme phosphotriesterase have been chosen as model biomolecules on the basis of their importance in biotechnology, their different properties and behaviors.

- Bovine serum albumin (BSA) is a large globular non-glycosylated protein. Due to its structural homology with human serum albumin (76% similarity) [1], it is one of the most studied serum albumin protein. It shows discrete binding sites with different specificities and it has been extensively used to study the interactions of ions, metal complexes and drug molecules with serum proteins [2],[3], [4] and also, for biosensors development, for example, for the detection of lead ion in solution [5].
- Protein G is an immunoglobulin-binding protein. It specifically binds to the constant region of many species of immunoglobulin G and it has been extensively used in affinity chromatography, especially for antibodies purification [6], [7]. More recently, it has been used in immunosensor design for the site-directed antibody immobilization on the sensor surface [8].
- Lipases are enzymes capable of catalyzing numerous reactions such as hydrolysis, esterification, interesterification, transesterification, alcoholysis, acidolysis. Thus, they are used in different fields, such as the dairy and food industries, in oleochemical industry, in medical applications [9]. They show superb chemoselectivity, regioselectivity and stereoselectivity and have been used for the production of optically active compounds for the pharmaceutical industries [10]. They have been also used for the development of membrane-based potentiometric biosensors, i.e for pesticide detection [11].
- Phosphotriesterases are enzymes able to catalyze the hydrolysis of synthetic organophosphate compounds [12]. They are of particular interest for the hydrolysis and detoxification of pesticides as an alternative to conventional chemical reactions [13], [14].

The covalent immobilization of the biomolecules on the membrane surface was carried out on different functionalized cellulose membranes. An ethylenediamine – glutaraldehyde spacer was also introduced between the membrane surface and the proteins.

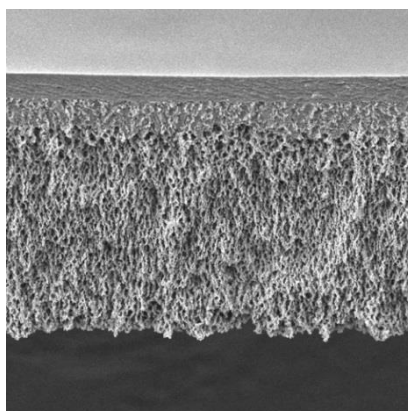
The immobilization behavior was investigated as a function of the initial protein concentration and it was correlated to proteins properties in solutions, including molecular size, charge, and aggregation.

Proteins surface coverage and rearrangement were checked by AFM and described by pseudo second order model. Finally, the performances of immobilized lipase, Protein G and phosphotriesterase were evaluated.

### 3. 1 Materials and chemicals

Lipase (from *Candida rugosa*, Type VII,  $\geq 700$  units/mg solid), bovine serum albumin (BSA), human IgG, sodium periodate ( $\text{NaIO}_4$ ,  $\geq 99.8$  %), ethylenediamine (EDA), glutaraldehyde (GA), ninhydrin, ethanol, glycine, ethyl paraoxon, 4-nitrophenol, HEPES sodium salt and trizma base were obtained from the Sigma-Aldrich Chemical Co. Recombinant Protein G  $>98$  % was purchased from Biovision. Sodium borohydride  $>98$  %, Pierce™ BCA Protein Assay Kit, NativePAGE™ Novex® Bis-Tris Gel System were obtained from Thermo Fischer Scientific. The enzyme phosphotriesterase was a mutant called Sso-3M from *Sulfolobus solfataricus*. It was a thermophilic enzyme produced by the Institute of Protein Biochemistry, National Research Council (Napoli, Italy). All other chemicals were of analytical grade and used without further purification.

Flat sheet Ultrafiltration regenerated cellulose (RC) membranes with MWCO (molecular weight cut off) of 100 kDa were purchased from Millipore (figure 3.1).



**Figure 3.1** SEM image of RC membrane (reprinted from [www.merckmillipore.com](http://www.merckmillipore.com))

## 3.2 Experimental methods

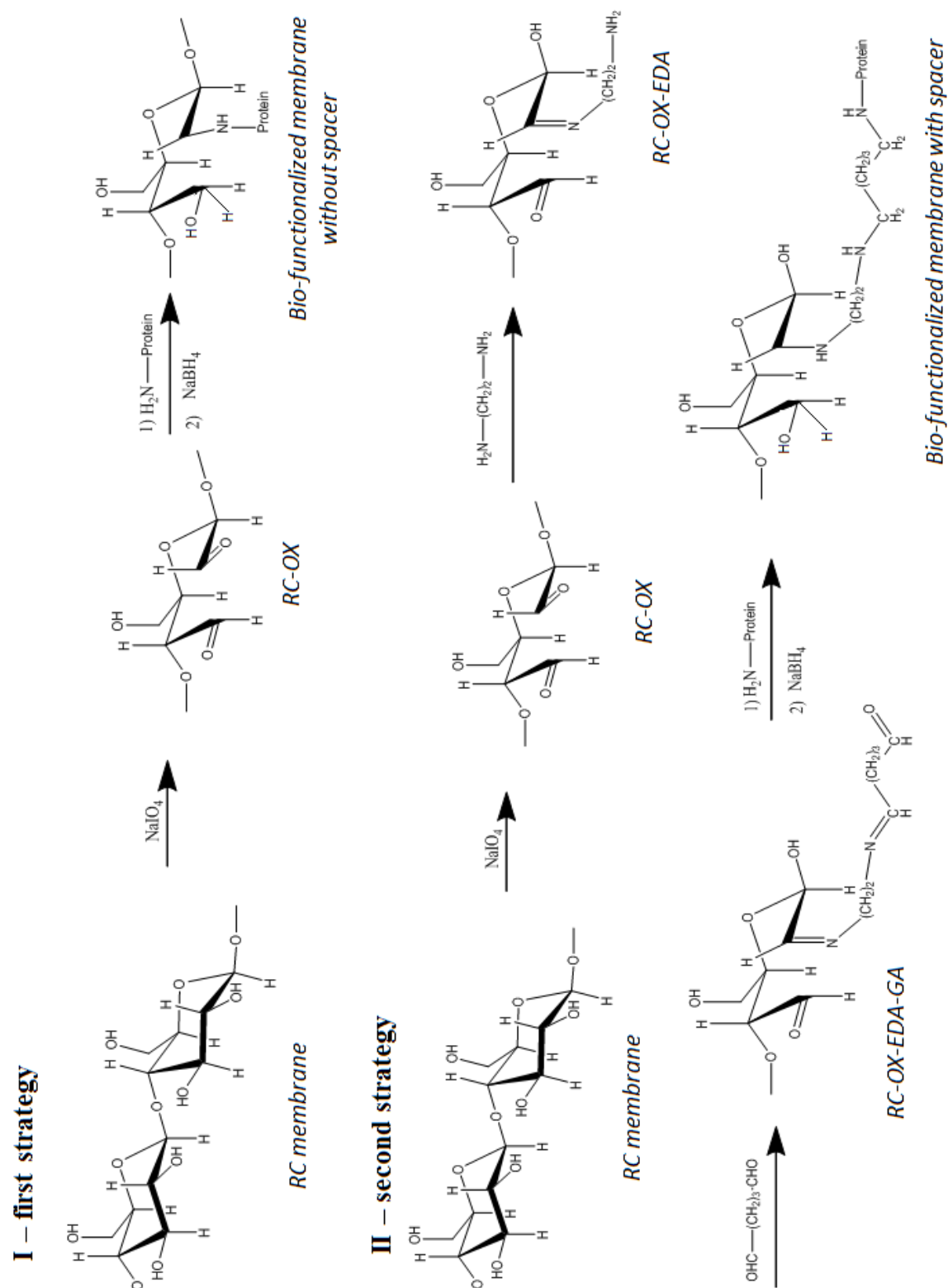
### 3.2.1 Membrane surface functionalization strategies

Regenerated cellulose (RC) membranes, with a very low protein adsorption capacity, were functionalized by chemical treatment in order to introduce on the surface reactive aldehyde groups able to bind proteins covalently. Two strategies were used for membrane modification and proteins immobilization:

- 1) Membrane oxidation (RC-OX) and subsequent proteins immobilization.
- 2) Introduction of a spacer arm between the membrane and the proteins (RC-OX-EDA-GA).

The mechanisms of reaction are illustrated in the figure 3.2 and the different steps are explained below.

RC membrane was cut into 1 cm diameter discs and washed sequentially with distilled water in order to remove glycerin as the preservative. Then, the membranes were immersed into  $\text{NaIO}_4$  aqueous solutions at different content (0.02, 0.2, 2.0 wt. %) to obtain aldehyde groups capable of immobilizing proteins. The oxidization reaction was carried out at room temperature in darkness for 7 h, and then the oxidized membranes (RC-OX) were thoroughly washed with distilled water. The RC-OX membranes were further used for proteins immobilization (figure 3.2-I). In the second strategy, for the introduction of the spacer (EDA), the RC-OX membranes were placed into an aqueous solution containing 5 wt. % EDA for 15 h. The membranes (RC-OX-EDA) were then rinsed several times using distilled water to remove any loosely bound EDA and further reacted with 5 wt % GA aqueous solution for 2 h. The membrane obtained (RC-OX-EDA-GA) was further used for proteins immobilization (figure 3.2-II).



**Figure 3.2** Schematization of two strategies used for membranes bio/chemical functionalization without (I) and with the spacer (II)

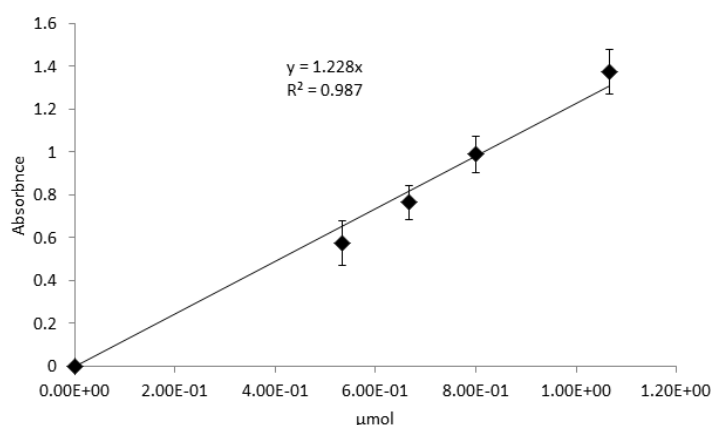
### 3.2.2 Functionalized membranes characterization

#### 3.2.2.1 Infrared analysis

Changes in the chemical functionality of the membranes were evaluated collecting infrared spectra onto the membrane surface in Attenuated Total Reflection Infrared (ATR-IR) mode. Spectra have been collected on pristine, RC-OX and RC-OX-EDA membranes by using an infrared spectrometer Thermo-Scientific Nicolet iS10.

#### 3.2.2.2 Ninhydrin test

The ninhydrin method was used to check the presence of amino groups after the introduction of the EDA spacer on the membrane surface. A small piece of membrane (1 cm<sup>2</sup>) was put in a tube containing 1 mL of ninhydrin reagent. The tube was heated in boiling water for 3 min, and the solution diluted with 5 mL of EtOH. Ninhydrin reacted with amino groups to form a purple-colored solution. The amine concentration was determined by measuring the UV absorbance at 570 nm. Glycine was used as standard to obtain a calibration curve for the quantification measurement of the amino groups (figure 3.3). The amino groups density was expressed as the amount of amino groups (μmol) per surface of membrane (cm<sup>2</sup>). The ninhydrin test (twice repeated) was also carried out on the RC-OX-EDA-GA membrane in order to evaluate the eventual presence of unreacted amino group.



**Figure 3.3** Calibration curve of Ninhydrin test obtained by using different contents (μmol) of glycine as standard.

### 3.2.2.3 Water permeance measurement

Water permeability measurements were performed in order to check membrane performance before and after the chemical functionalization. Membranes were loaded into a pressure filtration equipment with an efficient filtration area of 13.45 cm<sup>2</sup>. The water permeance ( $L_p$ ) was determined by the slope of the straight line obtained plotting the water flux values against the applied trans-membrane pressure according to the Darcy's law :

$$J_w = L_p \Delta p \quad (1)$$

Where  $J_w$  is the water flux (L/hm<sup>2</sup>), of and  $\Delta p$  is the applied trans-membrane pressure (bar).

### 3.2.3 Biomolecules characterization in solution

The biomolecules were characterized by using dynamic light scattering (DLS) and native polyacrylamide gel electrophoresis under the same operating conditions used during the immobilization step: phosphate buffer solution (PBS) 50 mM (pH 7) for BSA, lipase and protein G; 20mM HEPES buffer (pH 8) containing 0.2 mM CoCl<sub>2</sub> for the enzyme Sso-3M. All solutions were maintained at the temperature of 25 °C. The physicochemical properties of the biomolecules used are summarized in Table 3.1. The equivalent sphere radius of the protein is given by:

$$R_s = (3v_m/4\pi)^{1/3} \quad (2)$$

It was calculated using the protein molecular volume equation:

$$v_m = M / \rho_p A_v \quad (3)$$

where  $M$  is the protein molecular weight,  $\rho_p$  is the protein density (1.35 g/cm<sup>3</sup>) and  $A_v$  is the Avogadro number.

**Table 3.1** Physicochemical properties of the biomolecules used in this study

Biomolecule	~ Molecular weight (kDa)	pI	Equivalent sphere radius ( $R_s$ ) (nm)	Hydrodynamic Radius $R_H$ * (nm)
Bovine serum albumin	66	4.7	2.7	3.5
Recombinant protein G	26.1	4.5	1.9	< 3
Lipase from <i>C. rugosa</i>	67	4.5	2.7	-
Phosphotriesterase	~ 30	-	2.1	-

\*  $R_H$  values refer to native protein [15]

### 3.2.3.1 Dynamic light scattering

Proteins size distribution and aggregation phenomena were studied with a Zetasizer Nano ZS (Malvern Instruments).

Protein solutions were prepared at different concentrations: 0.1, 0.25, 0.5, 1 g/L for BSA, 0.25, 0.5, 1 g/L for Protein G, 0.1, 0.25, 1 g/L for lipase and 0.1 g/L for the enzyme Sso-3M. Kinetic studies of proteins aggregation over time were performed up to 6h. All the measurements were performed at 25°C.

Polydispersity was used to describe the width of particle size distribution and was expressed as polydispersity % (relative polydispersity, Pd %).

### 3.2.3.2 Native gel Electrophoresis

The apparent molecular mass distribution of the proteins used for the immobilization was evaluated by NativePAGE analysis (non denaturing gel electrophoresis) to maintain native protein conformation/complexes and was carried out on a Mini-Cell System (XCellSureLock™ Mini-Cell, Invitrogen). In this system, protein solutions at 0.1 g/L and the standard (NativeMark Unstained Protein Standard broad range, Novex) were used for the gel running (3-12% polyacrylamide percentage gel). After that, the gel was stained using a silver stain kit (SilverQuest™ Staining Kit, Invitrogen).

### 3.2.4 Biomolecules immobilization on functionalized membrane surface

The model proteins were immobilized on the functionalized membranes with (RC-OX-EDA-GA) and without (RC-OX) spacer. The immobilization was performed in batch conditions, with a gentle stirring, at controlled temperature (24°C). In the case of lipase, BSA and protein G, the protein solutions were prepared by dissolving protein powders in PBS 50 mM, pH 7. The enzyme phosphotriesterase was prepared by dissolving the enzyme powder in 20 mM HEPES buffer (pH 8) containing 0.2 mM CoCl<sub>2</sub>. Before the immobilization, the membrane discs (0.785 cm<sup>2</sup>) were equilibrated in PBS (pH 7) or HEPES buffer (pH 8) and then transferred into the protein solutions. After that, protein-immobilized membranes were washed several times with the buffer to remove any loosely bound protein.

#### 3.2.4.1 Reduction step optimization

After proteins immobilization, a reduction step was performed in order to stabilize the covalent linkage and to convert the unreacted aldehyde groups into the original hydroxyl groups (figure 3.2). Thus, the bio-functionalized membranes were treated with 50 mM sodium borohydride (NaBH<sub>4</sub>) in NaOH at 4°C. Different contact times (1, 5, 10, 15, 60 min) between the membrane and the reducing agent solution have been investigated as well. The conversion degree was measured directly with BCA test (as it can be also used for aldehyde groups determination), as described in the following, and was calculated as the absorbance value decreased, due to reduction, at 562 nm. The irreversibility of the binding between the membrane and the proteins was tested by performing desorption tests at acidic (PBS pH5.5) and basic (TRIS HCl pH 8.5) conditions, respectively.

#### 3.2.4.2 Effect of proteins concentration and contact time

The effect of contact time and proteins concentration on the immobilized amount of proteins was studied. For the kinetic studies, 1 mL of protein solution at different initial concentrations (0.1, 0.25, 0.5, 1 g/L for BSA and Protein G; 0.1, 0.25, 1 g/L for lipase and 0.1 g/L for Sso-3M ) was put in contact with a membrane surface of 0.785 cm<sup>2</sup> for different times.



### 3.2.4.3 Determination of the amount of immobilized biomolecules

The amount of immobilized protein was measured directly by using the BCA protein assay, as described by Stich [16]. The bio-functionalized membrane was incubated in the BCA working solution for 30 min at 37°C and then cooled down at room temperature. After 3 minutes the membrane was taken out and the absorbance of the solution was measured at 562 nm. RC functionalized membranes, reduced with NaBH<sub>4</sub>, without protein were used as blank. The protein loading was defined as the amount of protein (mg) per grams of membrane.

### 3.2.5 Membrane morphology

The topography of membranes was detected before and after functionalization and proteins immobilization by using Atomic Force Microscopy (AFM), Nanoscope III (Digital Instruments, VEECO Metrology Group). Tapping Mode TM AFM was operated by scanning a tip attached to the end of an oscillating cantilever across 8 to 25 μm<sup>2</sup> of samples surface for 512 points at a rate of 2.54 Hz.

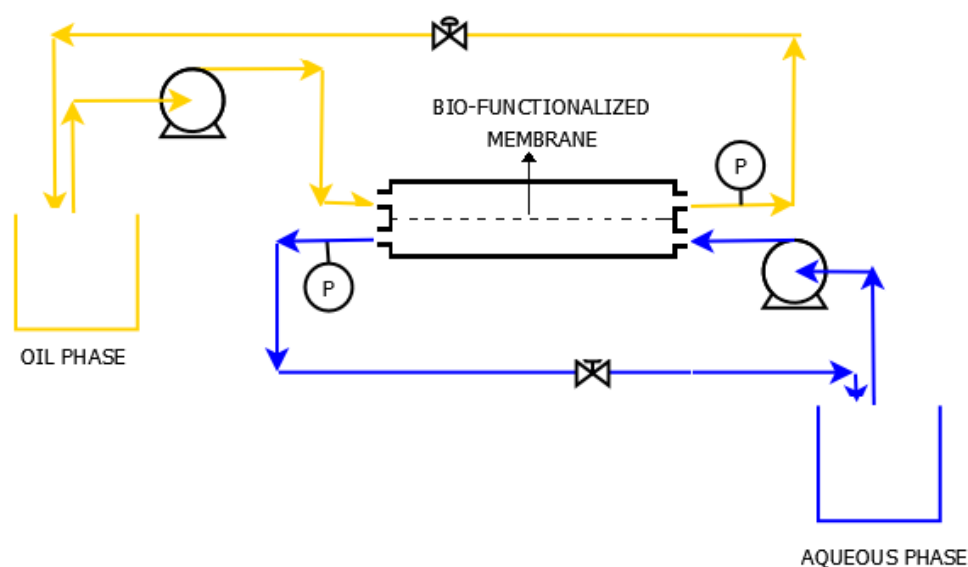
### 3.2.6 Performances of free and immobilized proteins

- Lipase from *C. Rugosa* activity assay

The activity of free lipase was determined by olive oil hydrolysis in a batch stirred tank bioreactor. The amount of fatty acids produced by the hydrolysis of triglycerides was measured and monitored by automatic titration using a MettlerDL21 titrator and 20 mM NaOH solution. The reaction mixture was formed by 19 mL PBS 50 m (pH 7), 1 mL of olive oil and 1 mL of enzyme solution. The mixture was stirred at 500 rpm by a magnetic stirrer to produce an oil–water interface and the temperature was kept constant at 30 °C. Specific activity was defined as units/mg enzyme (one unit (U) is defined as rate of production of 1 μmol of fatty acid per minute).

The activity of immobilized lipase as well, was monitored by titration of fatty acid extracted into the aqueous phase in a biphasic membrane bioreactor depicted in figure 3.4. It consisted of two compartments with an arrangement for holding the lipase-immobilized membrane between them (the effective surface area of the membrane was 9.1 cm<sup>2</sup>). A 150 ml of the substrate (olive oil) was circulated in the compartment facing the bio-functionalized membrane side, while in the other compartment a 150 ml of the aqueous

phase (PBS 50 mM, pH 7) was circulated with peristaltic pumps to control the flow rate of the two phases. The flow rate of oil phase was 25 mL/min, while the flow rate of aqueous phase was 270 mL/min. A low flow rate was used for the oil phase in order to increase the contact time between the substrate and the immobilized biocatalyst, on the other hand, a higher flow rate was used for the aqueous phase in order to increase the mass transport rate of the fatty acid from the reaction microenvironment to the aqueous phase bulk [17]. A blank run without enzyme on the membrane was performed as well. The activity retention value was calculated as the ratio of the specific activity of immobilized lipase with the respect to the free one.



**Figure 3.4** Schematic representation of the biphasic lipase-immobilized membrane bioreactor.

- Phosphotriesterase (Sso 3M) activity assay

The activity of the enzyme phosphotriesterase was determined by using the pesticide paraoxon, at concentration  $10^{-3}$  M, as substrate. The appearance of the reaction product 4-nitrophenol was monitored and was measured at 405 nm, in 1-cm path-length cell of 3 ml with a spectrophotometer equipped with a thermo-jacketed cell holder at 25 °C. The molar absorption coefficient used for 4-nitrophenol, estimated at 25 °C, was  $19920 \text{ M}^{-1}\text{cm}^{-1}$ . Specific activity was defined as units/mg enzyme (one unit (U) of enzyme activity is

defined as the amount of enzyme which liberates 1  $\mu\text{mol}$  of 4-nitrophenol per minute under assay conditions).

Immobilized Sso-3M was assayed in a similar manner. A strip of Sso-3M-immobilized membrane ( $4\text{ cm}^2$ ) was placed in a cell containing 3 mL of  $10^{-3}\text{ M}$  paraoxon in HEPES buffer and the absorbance at 405 nm was recorded. The activity retention value was also calculated.

- Protein G binding capacity

The performances of immobilized protein G were evaluated by using human IgG (hIgG) as model ligand. The binding capacity of the protein to hIgG was measured in static conditions by incubating the protein G-bound membrane with 1 g/L hIgG solution in 25 mM PBS, pH 5.8, containing NaCl (150 mM) for 6 hours with gentle mixing at room temperature. Using the BCA protein assay, the amount of bound IgG was calculated from the difference between the initial amount of IgG added in the reaction mixture and that in the final and wash solutions. The binding capacity of the membrane was defined as amount of IgG adsorbed (mg) per grams of membrane. The utilization efficiency of the binding domain of the attached protein G on the membrane was also evaluated.

### 3.3 Results and discussions

#### 3.3.1 Functionalized membranes characterization

The surface of commercial regenerated cellulose membrane was functionalized before immobilizing biomolecules through the three steps of reaction:

- 1) oxidation reaction by means of a  $\text{NaIO}_4$  solution, (RC-OX);
- 2) spacer introduction (EDA) resulting in a Schiff base formation (RC-OX-EDA);
- 3) activation by GA (RC-OX-EDA-GA).

According to scheme 3.2, in the first step, sodium periodate converts the secondary hydroxyl groups on the membrane surface into more reactive aldehyde groups that can be further employed as a binding site for covalent proteins immobilization. Results obtained by using different  $\text{NaIO}_4$  concentrations in aqueous solutions (0.02, 0.2, 2.0 wt.%) indicated that a higher oxidant concentration (2.0 wt.%) causes the damage of the membrane in terms of mechanical resistance. The lowest periodate contents (0.02 and 0.2

wt %) allow to avoid this drawback. However, only the FTIR-ATR spectrum collected on the cellulose membrane treated with the 0.2 wt.% solution shows a new peak at  $1733\text{ cm}^{-1}$  (figure 3.5-red) characteristic of aldehyde groups. Thus, this concentration was selected for subsequent studies.

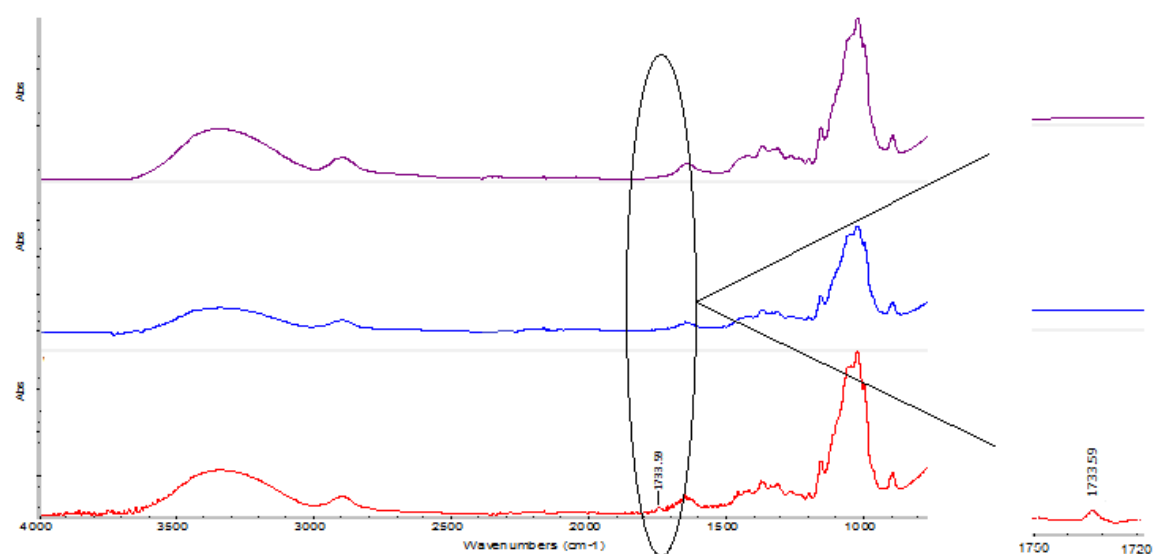
In the second step, the RC-OX membrane was modified with EDA to introduce the diamine spacer on the membrane surface by Schiff base formation. ATR-FTIR spectrum of RC-OX-EDA membrane (figure 3.6) confirms the replacement of the aldehyde groups with the amino groups of the spacer. In particular, the characteristic adsorption band attributed to the vibration of the aldehyde C=O groups disappears, while a new peak at  $1637\text{ cm}^{-1}$ , which can be attributed to the C=N stretching of the imine groups of the Schiff base, can be visualized.

Further confirmation of the presence of amino groups on the membrane was obtained by ninhydrin test as shown in figure 3.7. The ninhydrin reacted with the amino groups introduced on the membrane surface forming the characteristic purple-colored compound in solution. The calculated amino groups density was  $5.8 \cdot 10^{-2}\text{ }\mu\text{mol/cm}^2$ .

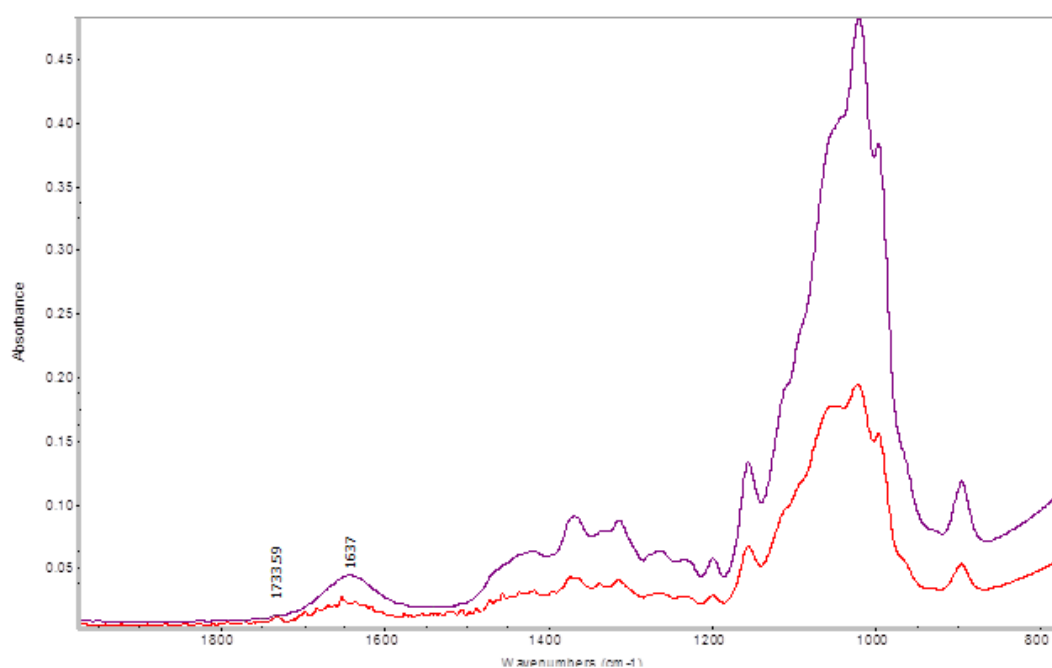
In the third step, the amino groups, previously introduced on the membrane surface, were activated with GA for the covalent attachment of the proteins. Even in this case, ninhydrin test was used to check the coupling of amino groups with GA. The colorless solution obtained clearly indicated the absence of free amino groups (figure 3.7).

In order to evaluate the membranes performance after chemical treatment, the functionalized membranes were characterized by water permeance measurement. As can be seen from figure 3.8, the water permeance did not significantly change after each step of functionalization confirming that this selected chemical treatment didn't alter the membrane quality and performance. A slight reduction is probably due to the introduction of less hydrophilic groups (CHO, NH<sub>2</sub>) respect to the O-H groups of the pristine membrane.

The membrane surface morphology, before and after the introduction of the spacer, was also evaluated. Figure 3.9 shows evident changes from pristine (A) to RC-OX-EDA-GA (B) membrane surface showing a surface roughness which increases from 7 to 180 nm after chemical functionalization with the spacer. After functionalization, RC-OX-EDA-GA surface appears spongier.



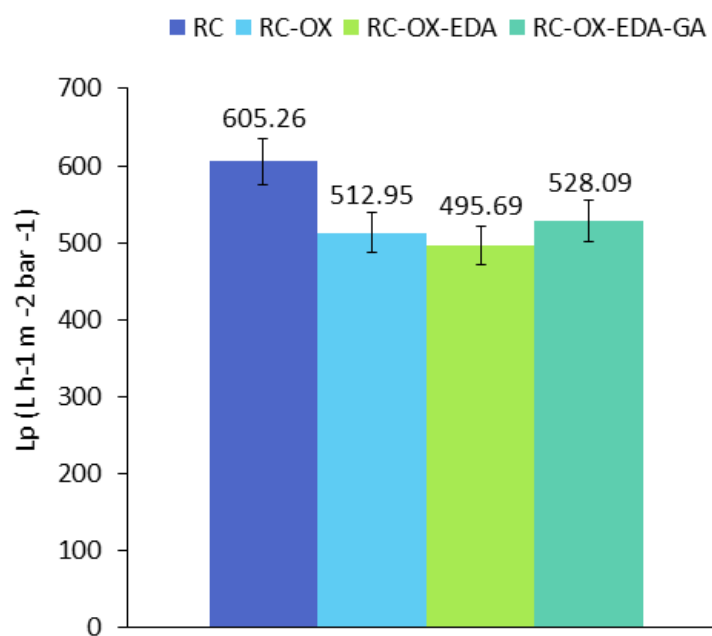
**Figure 3.5** ATR-FTIR spectra of pristine (violet) and oxidized membranes with  $\text{NaIO}_4$  0.02 wt% (blue) and 0.2 wt % (red). A magnification for the marked circle is depicted on the right representing the range from 1750 to 1720  $\text{cm}^{-1}$ .



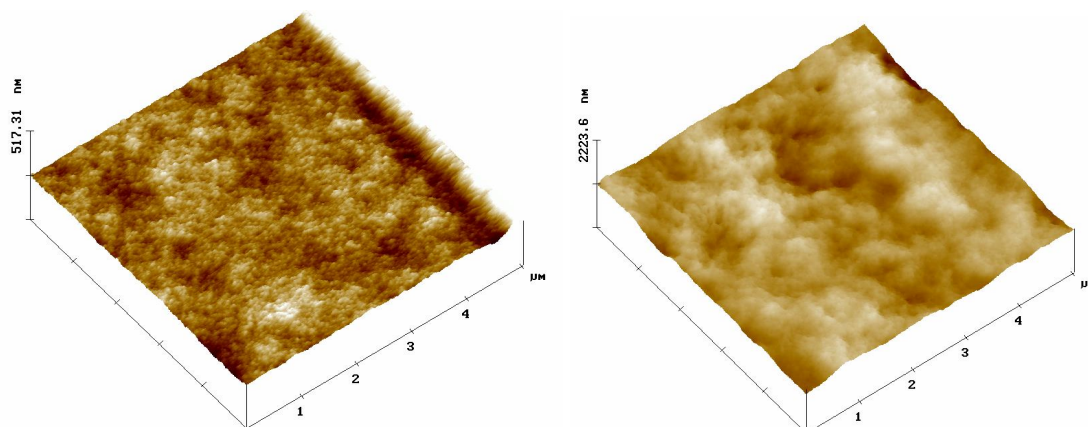
**Figure 3.6** ATR-FTIR spectra of oxidized (red) and aminated (violet) membranes



**Figure 3.7** Ninhydrin test of RC-OX-EDA (left) and RC-OX-EDA-GA (right) membranes



**Figure 3.8** Membrane water permeance after each step of functionalization



**Figure 3.9** 3D AFM images of pristine RC membrane (left) and RC-OX-EDA-GA functionalized membrane (right).

### 3.3.2 Biomolecules characterization

Before proteins immobilization on the functionalized membrane surface, BSA, protein G, lipase and phosphotriesterase were characterized by DLS and electrophoresis measurements. These measurements were mandatory to understand the aggregation phenomena which take place at the solid-liquid interface during the immobilization step. Different reports in literature describe aggregation phenomena in relation to several bulk properties, such as protein concentration, ionic strength, pH and temperature [18]. Herein, the possible aggregation phenomena were studied in relation to biomolecules concentration and their particle size distribution under the operating conditions used during the immobilization step. Therefore, in the case of BSA, protein G and lipase, the pH, the ionic strength and the temperature were fixed at 7, 0.11 M and 25 °C, respectively, to carry out the immobilization reaction in mild conditions. In the case of phosphotriesterase a different buffer at pH 8 was selected on the basis of the optimal parameters for the enzyme. Data obtained from DLS and Electrophoresis measurements for all the proteins and concentrations studied are summarized in table 3.2.

For all the proteins analyzed, the particle size distribution was not influenced by the bulk concentration according to the results reported by B. Jachimska *et al.* [19]. Indeed the same particle size distribution was obtained by varying the biomolecules concentration from 0.1 g/L to 1 g/L (figures 3.10-A, 3.11-A and 3.12-A). DLS measurements of BSA solutions indicate a wide particle size distribution with an average diameter value of around 10-11

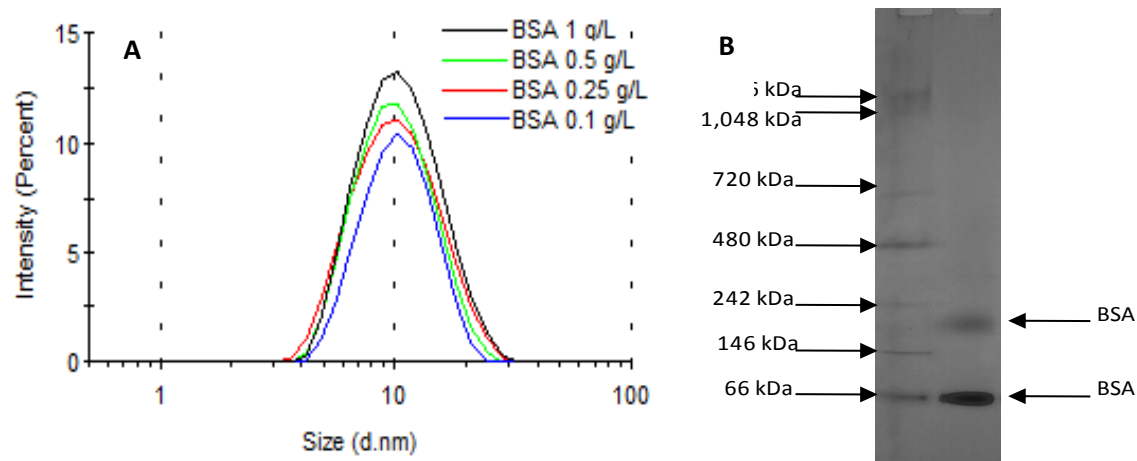
nm (figure 3.10-A), whereas, the reported hydrodynamic diameter of a BSA monomer is approximately 7 nm [20]. Results demonstrate that the protein is present in different forms in the used experimental conditions. Electrophoresis results (Figure 3.10-B), carried out in native conditions, suggest that the protein is mainly present as monomer (~65 kDa) with some trimers (~193 kDa). The stability of the protein in solution was also evaluated by following changes in the hydrodynamic diameter up to 6 h. There were no significant changes in the protein profile, indicating that the protein is also stable over time.

Even for the protein G, the diameter size distribution (Figure 3.11-A) suggests an association of protein molecules, most probably forming compact dimers at each concentration (average diameter size of about 7 nm). Indeed, based on crystal structure and hydrodynamic studies reported in literature [15, 21], the estimated hydrodynamic radius of recombinant protein G is less than 3 nm. This was confirmed by the native gel electrophoresis results (Figure 3.11-B) showing an apparent molecular weight of ~47 kDa that is twice the molecular weight of a monomer.

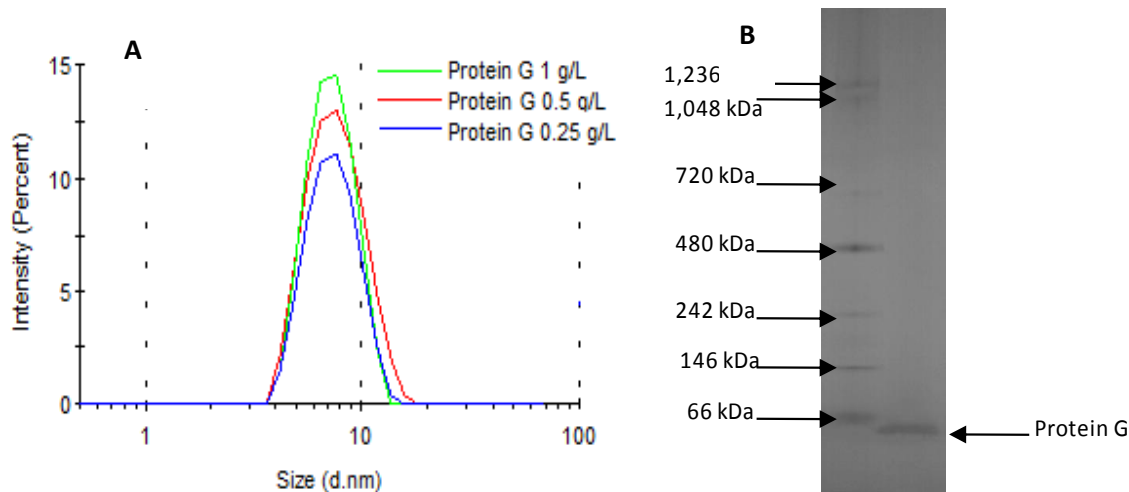
For lipase, a bimodal diameter size distribution was obtained (Figure 3.12-A) with high diameter size values, indicating the presence of larger aggregates. Moreover, the profile of the protein changed upon time indicating a continuous interaction of the particles. The high aggregation behavior of lipase was clearly demonstrated by Native gel electrophoresis (Figure 3.12-B) from which it is possible to see an apparent molecular weight >1200 kDa and only a small fraction of ~72 kDa. Even in the case of phosphotriesterase, a bimodal size distribution was obtained (figure 3.13-A) indicating the presence of large aggregates. This was confirmed by the native gel electrophoresis results (Figure 3.13-B) showing two different bands with apparent molecular weight values of ~90 and ~300 kDa that are significantly higher than the molecular weight of a monomer.

The analysis of the aggregation behavior of the proteins indicated that in the investigated conditions, BSA and protein G exhibit a not significant aggregation, while lipase and phosphotriesterase strongly tends to aggregate.

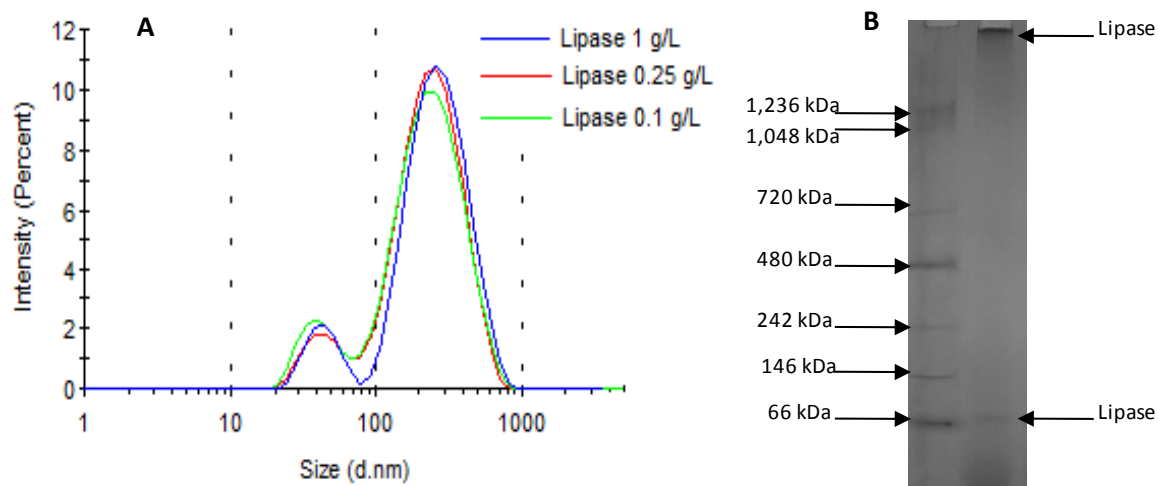




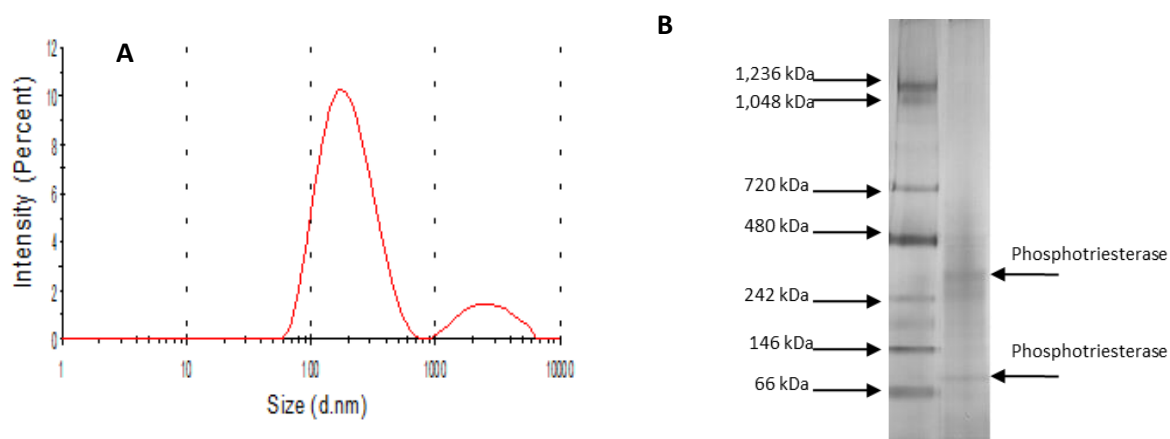
**Figure 3.10** Particle size distribution (A) and Electrophoresis in native conditions (B) of BSA



**Figure 3.11** Particle size distribution (A) and Electrophoresis in native conditions (B) of protein G



**Figure 3.12** Particle size distribution (A) and Electrophoresis in native conditions (B) of lipase



**Figure 3.13** Particle size distribution (A) and Electrophoresis in native conditions of phosphotriesterase (B)

**Table 3.2** Summary of results obtained from DLS and Electrophoresis measurements for all concentrations tested of each protein

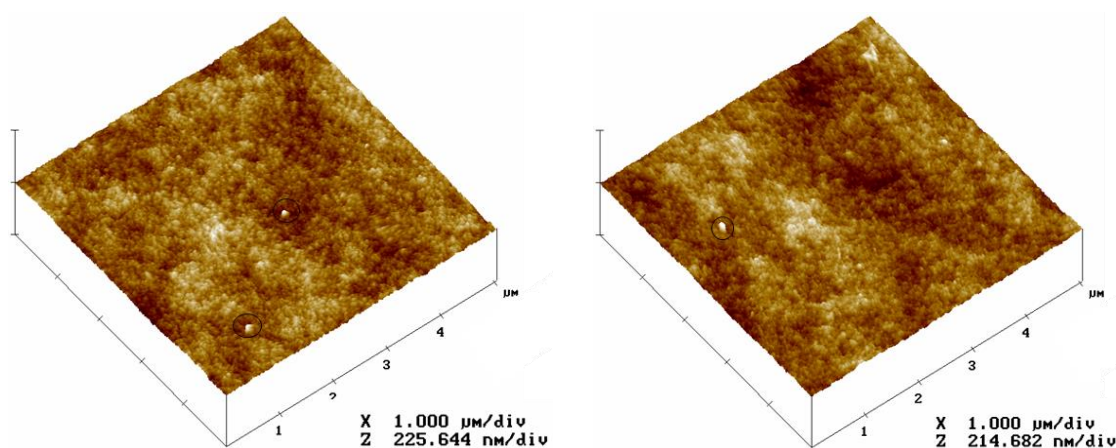
Protein	Concentration (g/L)	Average diameter (nm)	Pd (%)	~Apparent molecular weight (kDa)
BSA	1	11.05 ± 4.3	39	65 – 193
	0.5	10.5 ± 3.8	36.6	
	0.25	10.07 ± 3.4	34.4	
	0.1	10.4 ± 3.4	32.7	
Protein G	1	7.3 ± 1.7	24.2	47
	0.25	7.8 ± 2.2	27.9	
	0.1	7.4 ± 1.9	25.8	
Lipase from <i>C. Rugosa</i>	1	44.2 ± 11.67	26.4	72 – > 1200
		288.9 ± 128.4	44.4	
	0.25	43.9 ± 12.4	28.4	
		258.3 ± 120	46.4	
	0.1	42.08 ± 12.3	29.2	
		259.1 ± 126.4	48.8	
Phosphotriesterase	0.1	210.6 ± 102.9	48.9	90 – 317
		2781 ± 1173	42.2	

### 3.3.3 Biomolecules immobilization

#### 3.3.3.1 Adsorption tests

Before immobilizing the biomolecules on the activated membranes, adsorption tests were carried out on the RC pristine membrane. Results evidenced that no biomolecules adsorption occurred on the membrane surface at the operating conditions described in the section 3.2.4, confirming that RC has a negligible proteins adsorption capacity. This was

also confirmed by the AFM results. As can be noted from figure 3.14, the membrane morphology, after lipase and BSA adsorption, remains unchanged if compared to the pristine membrane (figure 3.9). Only a negligible deposition of some small cluster is evidenced. Therefore, only the formation of covalent bond is responsible of the protein immobilization on the membrane according the procedure described in section 3.2.4.

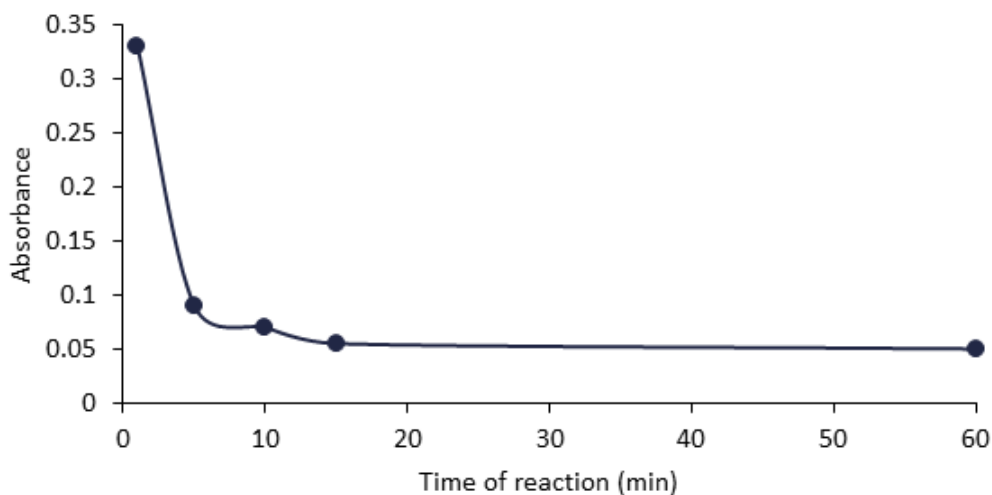


**Figure 3.14** AFM images of lipase (I) and BSA (II) adsorbed on RC virgin membrane

### 3.3.3.2 Reduction step optimization

The reduction step with  $\text{NaBH}_4$  was carried out in order to stabilize the covalent linkage between the membrane and the proteins and to convert the unreacted aldehyde groups into the original hydroxyl groups according to figure 3.2. Therefore, before studying the proteins immobilization trend on the functionalized membranes, the reduction step was optimized. BCA test was used to determine the conversion degree as explained in section 3.2.4.1. Thus, RC-OX and RC-OX-EDA-GA membranes were put in contact with a  $\text{NaBH}_4$  solution for different times (1, 5, 10, 15, 60 min) and the absorbance of the solution, after reaction with the BCA reagent, was recorded at 562 nm. Results for RC-OX membrane are shown in figure 3.15. As can be noted, by increasing the reaction time, the absorbance value decreases, indicating the reduction of aldehyde groups to hydroxyl groups. After 15 minutes of reaction, no further absorbance decrease was evidenced indicating that all the free aldehyde groups, and consequently also the imino groups, were

converted. Indeed, it is known that  $\text{NaBH}_4$  reduces in a non-selective way both aldehyde (to hydroxyl groups) and imino unstable groups (to N-C stable bond). Thus, a reduction time of 15 minutes was selected for subsequent experiments.



**Figure 3.15** Absorbance value as a function of reaction time with  $\text{NaBH}_4$  to optimize the reduction step ( $\lambda = 562$  nm)

### 3.3.3.3 Biomolecules immobilization trend

The effect of biomolecules concentration and contact time between biomolecules solution and RC-OX and RC-OX-EDA-GA membranes on the covalent immobilization rate was investigated. In particular, for BSA immobilization, the functionalized membranes were put in contact with four solutions at different concentrations (0.1, 0.25, 0.5, 1 g/L) for different times under static conditions. Results in terms of amount of immobilized BSA on RC-OX and RC-OX-EDA-GA over the time are shown in figure 3.16. The amount of immobilized BSA increases with time until reaching a plateau  $2.40 \pm 0.07$  mg/g. At low concentration ( $< 0.25$  g/L) more time is required to reach the surface saturation coverage (more than 24h for RC-OX). These results permit to conclude that the saturation coverage does not depend on the BSA concentration. On the contrary, the initial immobilization rate depends on the biomolecules concentration until 0.2 g/L, after this value it becomes independent. The lowest rate at lower concentration is due to the mass transport limitation effects of the protein molecules from the bulk to the membrane surface.

It also should be noted that the kinetics of immobilization on the functionalized membranes is faster when the spacer is present, making the aldehyde groups more accessible. According to literature, the immobilization of biomolecules on aminated supports activated with glutaraldehyde occurs through a double mechanism, consisting of protein adsorption in a first step, followed by covalent immobilization in a second step [22]. The contribution of ionic groups (protonated amino groups of EDA) to the immobilization rate has to be considered as well. Actually, ionic groups at particular pH values impart a certain degree of anionic exchange ability to the membrane. For this reason, at low ionic strength, protein immobilization occurs via a first rapid ionic interaction of the protein with the protonated amino groups, followed by the covalent reaction [23]. Taking into the account that all the tested proteins are negatively charged at the pH used for the immobilization (isoelectric point in the range of 4.5–4.8), the quickest immobilization rate obtained in this work can be ascribed to the action of both the ionic and covalent mechanisms.

In the case of Protein G (figure 3.17), the initial immobilization rate increases with increasing biomolecule concentration and, even in this case, the saturation coverage is concentration independent.

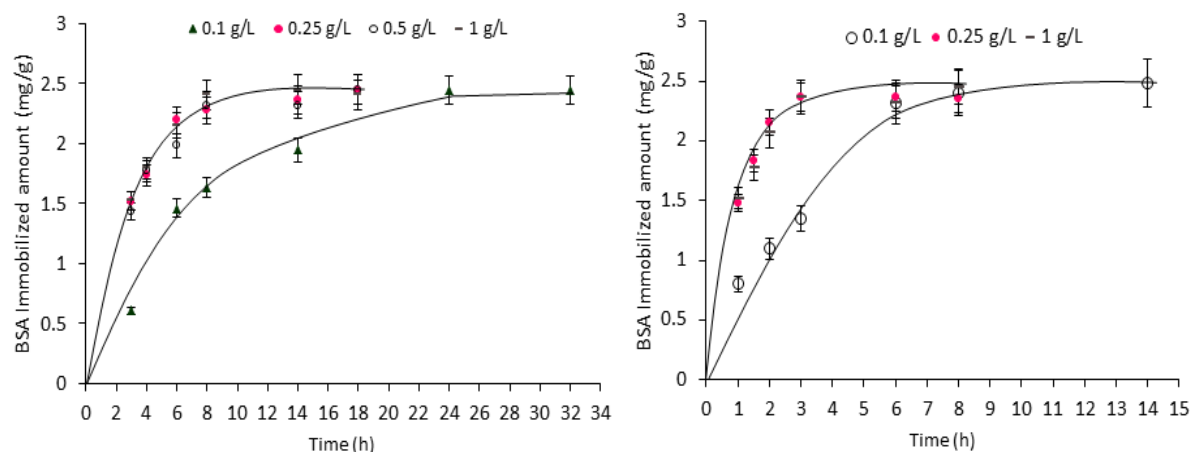
It is worthy to remark that BSA and protein G immobilization is an irreversible phenomenon. Indeed, as shown in figure 3.18, the binding isotherms are both parallel to the concentration axis over the entire concentration range from 0.1 to 1 g/L, as expected in the case of non-equilibrium irreversible process.

Desorption tests, performed to evaluate the irreversibility of the binding between the biomolecules and the functionalized membranes confirmed that no proteins desorption occurs after the immobilization. This result undoubtedly proves that the proteins are covalently anchored to the membrane surface.

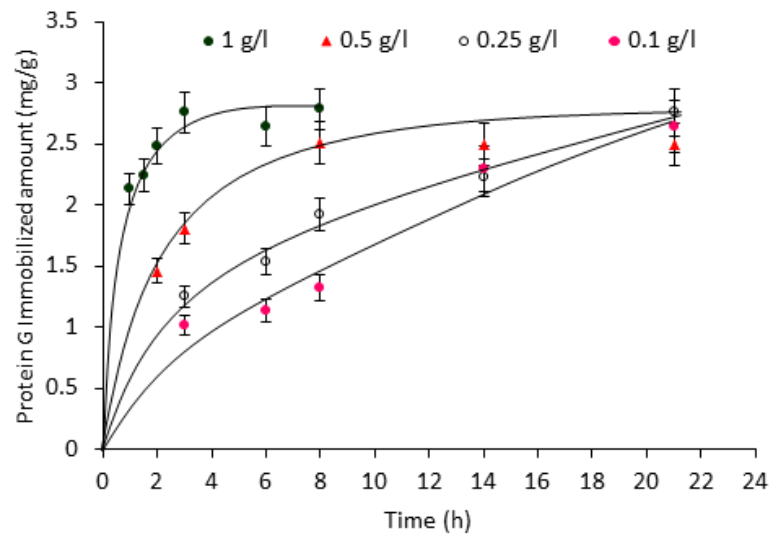
The process irreversibility and the shape of the binding kinetics curves for BSA and Protein G, suggest that the saturation surface is constituted by a protein monolayer.

A different behavior was found for the enzymes lipase and phosphotriesterase. As can be seen from figure 3.19, for the enzyme lipase, the surface coverage does not reach saturation even after 18h (experiments were conducted also for 48h without reaching the plateau) and the trend observed for the binding kinetic curve of the enzyme suggests the formation of a multilayer, with a high amount of immobilized protein. This hypothesis is in agreement with the DLS results that evidence the presence of high protein aggregates, which increase over time. The high aggregation of the protein at each examined

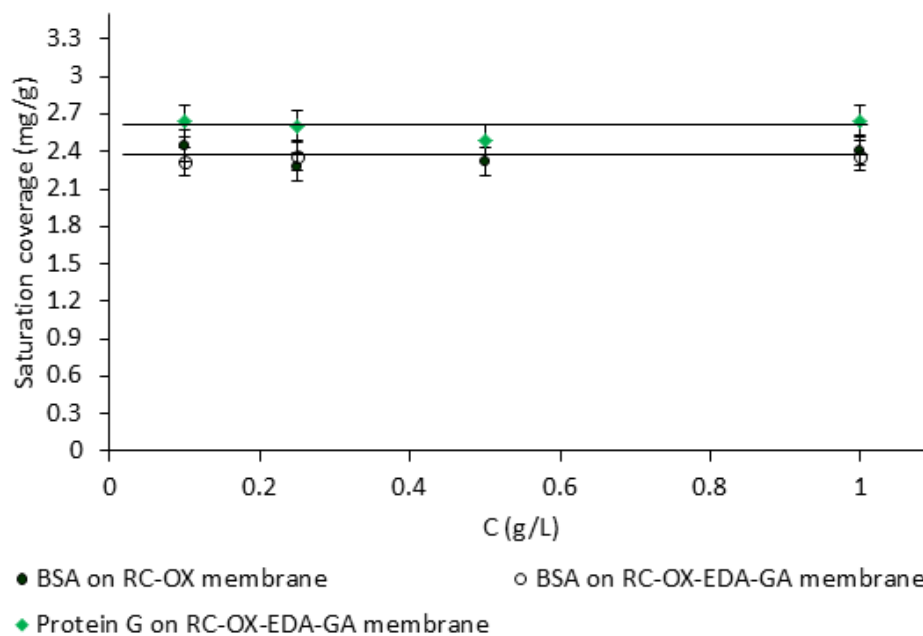
concentration may explain the unusual trend of the binding kinetic curve, further confirming the formation of multilayers on the membrane surface. A similar trend is shown for the enzyme phosphotriesterase (figure 3.20). Also in this case, the unusual binding kinetic curve can be explained by the possible formation of multilayers due to protein aggregation phenomena evidenced by DLS results.



**Figure 3.16** Effect of contact time and initial protein concentration on BSA immobilization onto RC-OX (left) and RC-OX-EDA-GA (right).

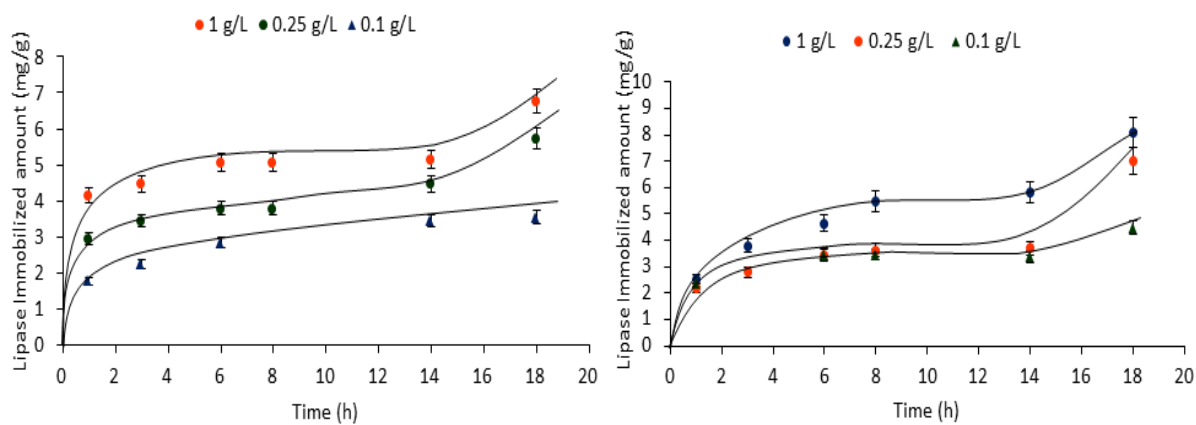


**Figure 3.17** Effect of contact time and initial protein concentration on protein G immobilization onto RC-OX-EDA-GA.

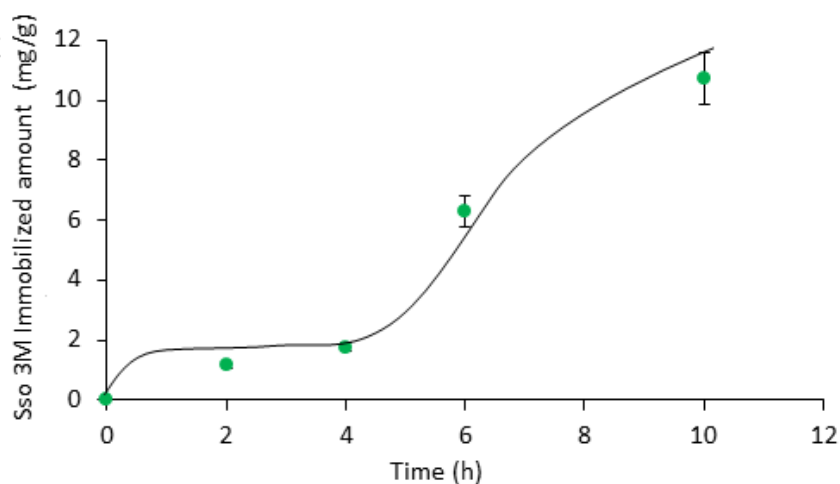


**Figure 3.18** Irreversible binding isotherm





**Figure 3.19** Effect of contact time and initial protein concentration on lipase immobilization onto RC-OX (left) and RC-OX-EDA-GA (right).



**Figure 3.20** Effect of contact time on phosphotriesterase immobilization onto RC-OX-EDA-GA

### 3.3.4 Kinetics of immobilization

Predicting the rate at which the immobilization takes places in a given solid system is one of the most crucial factors for the effective immobilization design. Numerous kinetic models have been proposed to predict the behavior of the experimental data that take in the accounts combined effects such as transport, diffusion and adsorption/desorption of the solute molecules. Kinetic models that assume the “surface reaction” as the controlling step of overall sorption rate are based on the pseudo-first order, pseudo-second order and Elovich equations [24]. The pseudo-first and Elovich equation are restricted to the initial times of immobilization process, and then are not suitable for the description of the slow immobilization kinetics observed in this study. The rate equation which better describes the behavior of the obtained experimental results is the pseudo-second order kinetic model:

$$\frac{dq_t}{dt} = (q_e - q_t)^2 \quad (4)$$

It can be integrated with the boundary condition  $q(t = 0) = 0$  and rearranged to obtain a linear form:

$$\frac{t}{q_t} = \frac{1}{kq_e^2} + \frac{t}{q_e} \quad (5)$$

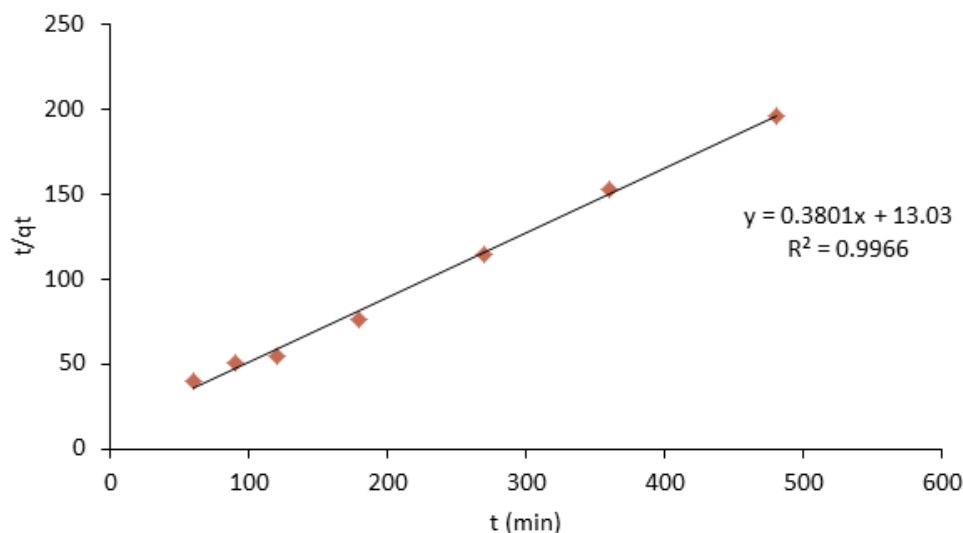
where  $k$  is the equilibrium constant rate,  $q_e$  and  $q_t$  are the amount (mg/g) of immobilized biomolecules on the membrane surface at equilibrium (saturation) and at time  $t$ , respectively.

The  $q_e$  and  $k$  parameters were determined directly from the slope and the intercept of the  $t/q(t)$  against  $t$  linear plot. Furthermore, the initial immobilization rate can be calculated from:

$$h = kq_e^2 \quad (6)$$

An example of linear plot for BSA (1 g/L concentration) immobilization kinetics on RC-OX-EDA-GA is shown in figure 3.21. In table 3.3 are reported all the kinetic parameters for BSA and protein G immobilization on RC-OX and RC-OX-EDA-GA with the correlation coefficients. The correlation coefficients were found to be in the range 0.995-0.998 indicating a well agreement with the experimental data. Results derived from

applying the pseudo-second order model confirmed the surface reaction is the controlling step of immobilization kinetics.



**Figure 3.21** Linear plot of pseudo-second order rate for BSA (1 g/L concentration) immobilization on RC-OX-EDA-GA

**Table 3.3** Kinetic parameters for immobilization of BSA and protein G molecules on RC-OX and RC-OX-EDA-GA.

Protein	Concentration (mg/ml)	Parameters				
		$R^2$	$K$ (g/mg min)	$h$ (mg/g min)	$Q_e$ (mg/g)	
					$q_{e_{exp}}$	$q_{e_{calc}}$
BSA on RC-OX	0.1	0.998	$9.21 \cdot 10^{-4}$	$7.92 \cdot 10^{-3}$	2.45	2.93
	0.25	0.996	$3.19 \cdot 10^{-3}$	$2.37 \cdot 10^{-2}$	2.41	2.72
	0.5	0.996	$3.16 \cdot 10^{-3}$	$2.24 \cdot 10^{-2}$	2.38	2.66
	1.0	0.995	$3.33 \cdot 10^{-3}$	$2.41 \cdot 10^{-2}$	2.42	2.70
BSA on RC-OX-EDA-GA	0.1	0.995	$3.25 \cdot 10^{-3}$	$2.53 \cdot 10^{-2}$	2.40	2.79
	0.25	0.996	$1.35 \cdot 10^{-2}$	$8.78 \cdot 10^{-2}$	2.35	2.55

	1.0	0.997	$1.11 \cdot 10^{-2}$	$7.68 \cdot 10^{-2}$	2.38	2.63
	0.1	0.996	$8.33 \cdot 10^{-4}$	$9.18 \cdot 10^{-3}$	2.62	3.32
Protein G on RC-	0.25	0.996	$1.06 \cdot 10^{-3}$	$1.03 \cdot 10^{-2}$	2.68	3.12
OX-EDA-GA	0.5	0.996	$3.71 \cdot 10^{-3}$	$2.91 \cdot 10^{-2}$	2.57	2.80
	1.0	0.998	$1.76 \cdot 10^{-2}$	$1.47 \cdot 10^{-1}$	2.73	2.89

### 3.3.5 Bio-functionalized membranes surface morphology

Morphological analyses were performed by AFM on the bio-functionalized membranes, in order to check the membrane surface coverage and protein rearrangement after covalent immobilization.

Taking into account the immobilization kinetics, the bio-functionalized membranes with BSA and protein G were investigated at the saturation state, whereas lipase-functionalized membranes were screened after 1 h and 20 h of contact time.

AFM topographies clearly showed that the proteins covalently anchored to the membrane surface form both discrete clusters and cord-like supra-molecular structures (figure 3.22). Specifically, immobilized BSA assumes an almost linear structure reaching a depth of around 15 nm and some cluster structures of 50 nm. The latter can be ascribed to occasional deposition of some oligomers just formed in solution, as suggested by DLS and electrophoresis experiments.

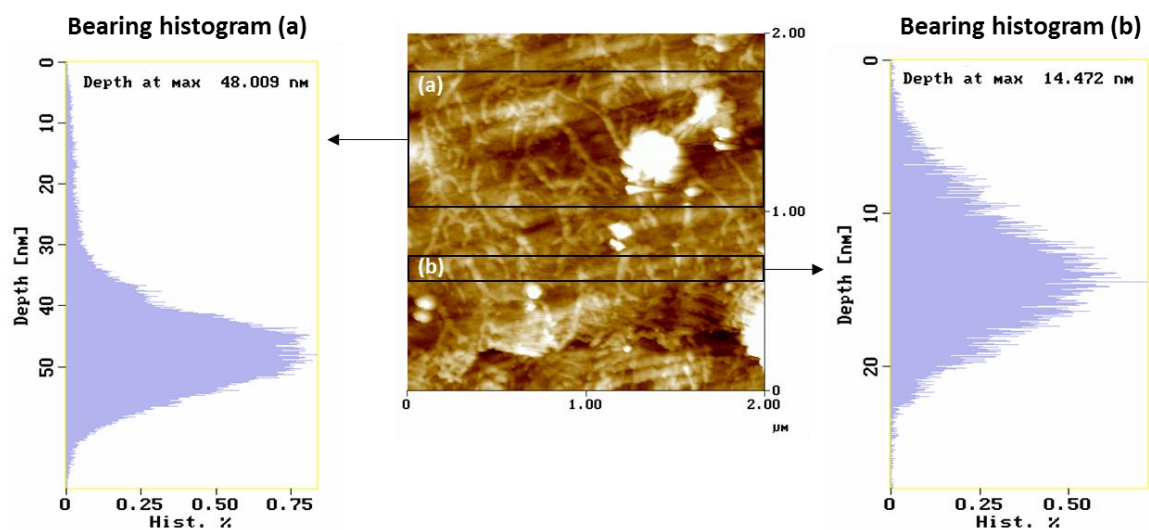
A tortuous texture can be also observed for covalently immobilized protein G on RC-OX-EDA-GA membranes (figure 3.23). No significant globular protein aggregates are detectable in agreement with what observed in solution. Protein filaments depth ranges from 6 to 9 nm for the thinnest filaments comparable to dimers in solutions and from 10 to 20 nm for the thickest ones.

For both BSA and protein G, the experimental evidences yield indication about the formation of a monolayer onto the membrane surface.

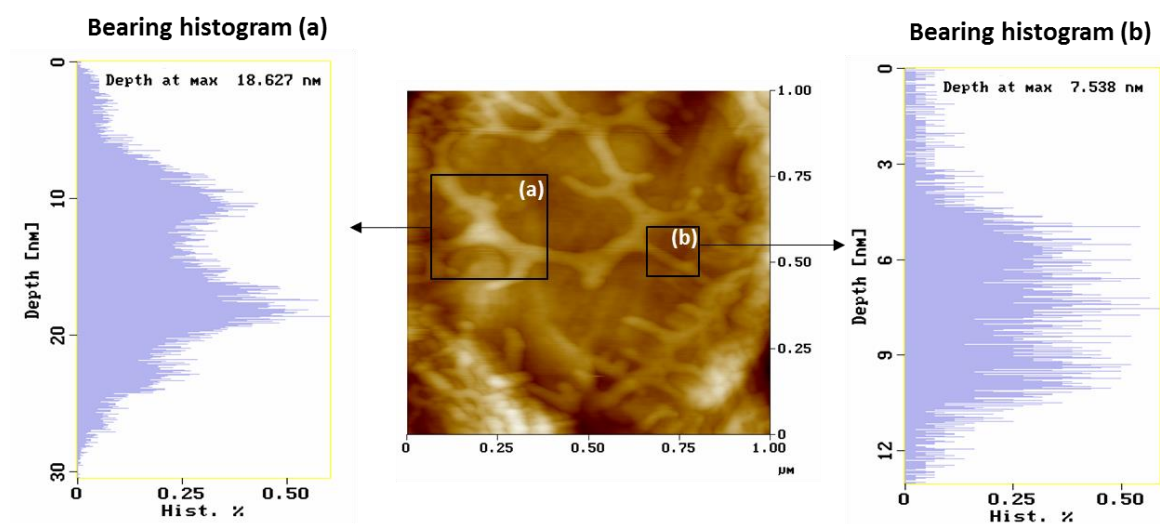
Lipase AFM micrographs (figure 3.24) yield indication about the different behavior of lipase confirming the multilayer formation as already hypothesized considering protein size distribution and immobilization kinetic trends (figure 3.19). Small lipase globular aggregates can be already detected after 1 h of contact between membrane and protein solution with a depth at 14 nm, thus leading to a full coverage of the surface with

formation of a massive loading protein that preserves its native globular structure forming a multilayer, with a maximum peak to valley height of 60 nm.

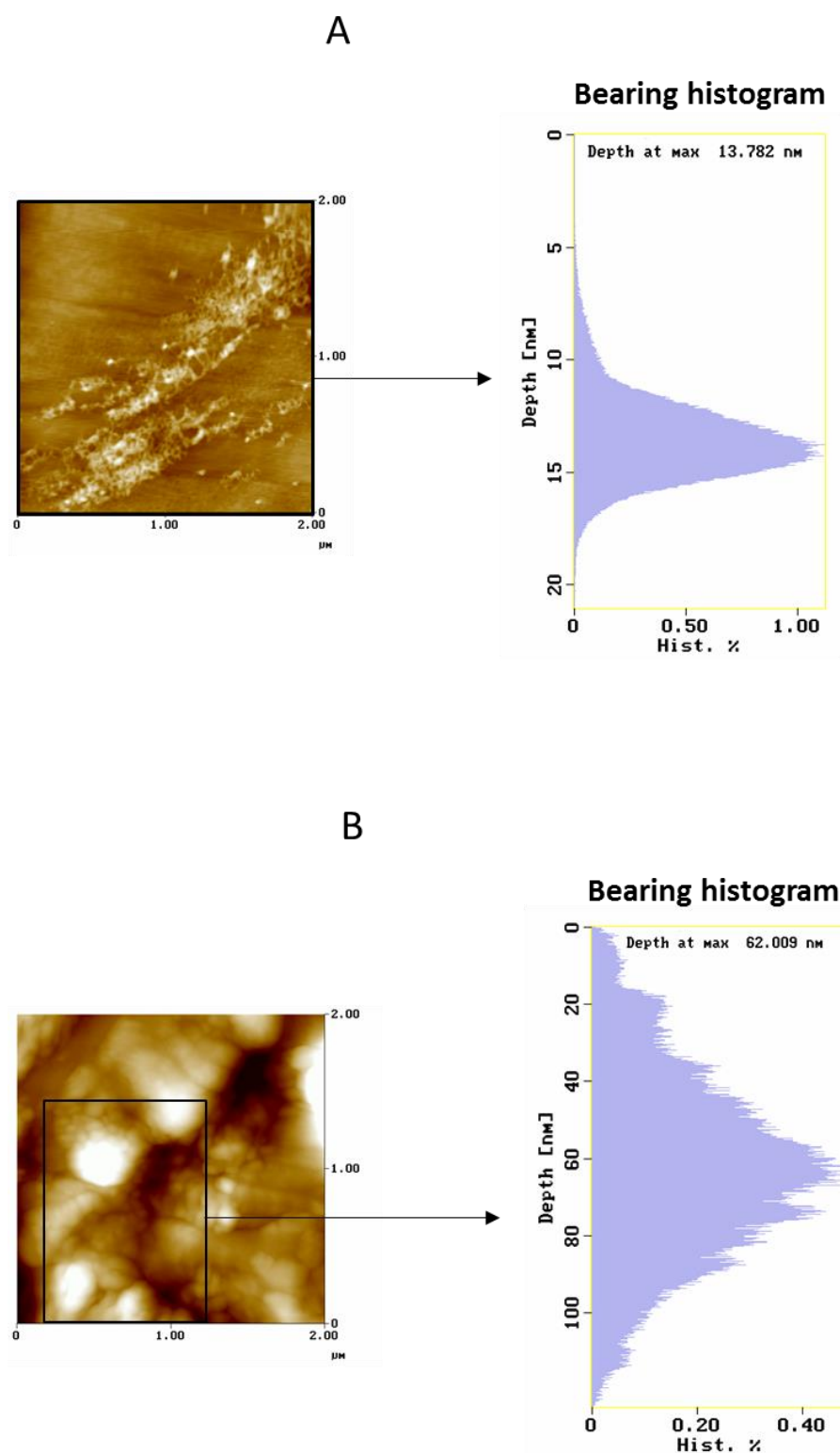
AFM results of immobilized BSA and protein G confirm that the protein-membrane surface interactions are due to the formation of covalent bonds promoted by membrane surface functionalization with suitable pendant groups. Protein organization on membrane surface exactly reflects their behavior in solution, leading to the formation of monolayers. On the other hand, lipase organization on the membrane surface suggests that protein-membrane surface and protein-protein interactions are both present until the complete surface coverage. This latter promote multilayer formation on the bio-functionalized membrane surface by means of protein-protein interactions. Undoubtedly, the establishment of covalent bonds has the advantage of preserving the immobilized proteins from leaching or denaturation over time, even if it restrains protein molecules decreasing their degrees of freedom. However, it does not necessarily imply a loss of bioactivity, as confirmed by activity tests hereafter reported.



**Figure 3.22** AFM image of RC-OX-EDA-GA membranes with covalently immobilized BSA after 4 h of incubation. The bearing histograms for the marked squares (a and b) are depicted respectively. (a) Some cluster structures with a depth of around 50 nm and (b) protein filament depth of around 15 nm.



**Figure 3.23** AFM image of RC-OX-EDA-GA membranes with covalently immobilized protein G after 4 h of incubation. The bearing histograms of the marked squares (a and b) are depicted respectively. Protein filaments depth ranges from 6 to 9 nm for the thinnest filaments (b) and from 10 to 20 nm for the thickest ones (a).



**Figure 3.24** AFM images of RC-OX-EDA-GA membranes with covalently immobilized lipase after 1 h (A) and 20 h (B) of incubation. The bearing histograms for the marked squares are depicted for both A and B. Small lipase globular aggregates can be detected after 1 h of incubation with a depth at around 14 nm (A), while large aggregates are detected after 20 h of incubation with a maximum peak to valley height of around 60 nm.

### 3.3.6 Performances of free and immobilized proteins

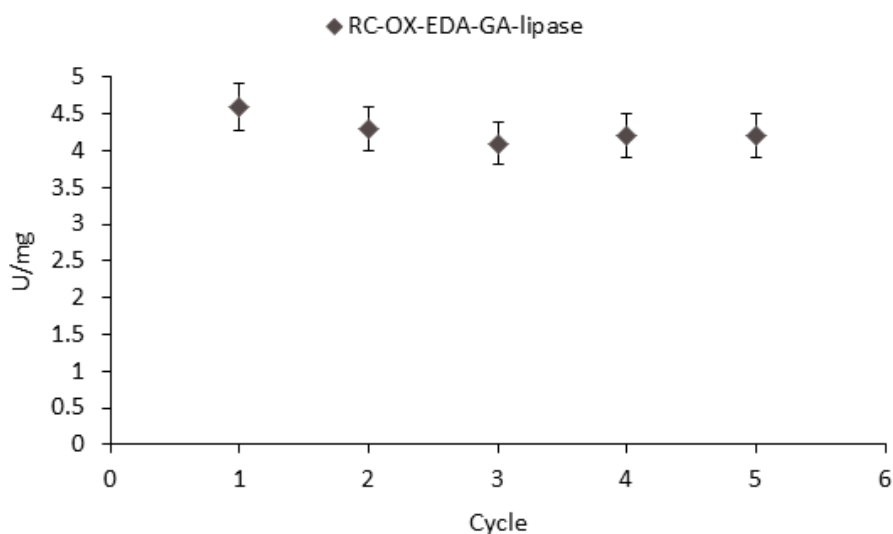
After the covalent immobilization on the functionalized RC membranes, the performances of lipase, phosphotriesterase and protein G were evaluated.

Lipase activity was measured after 20 h of immobilization both on RC-OX and RC-OX-EDA-GA.

The specific activity and activity retention of the immobilized lipase were compared to the free system. Results are summarized in table 3.4. Good results were obtained for lipase immobilized on RC-OX-EDA-GA with higher activity retention of 65 % and with constant performance after five reaction cycles of six hours each (figure 3.25).

**Table 3.4** Hydrolytic activity for free and immobilized lipase

Sample	Specific activity (U/mg)	Activity retention (%)
Free lipase	$7.2 \pm 0.21$	100
Immobilized lipase on RC-OX	$1.3 \pm 0.04$	18
Immobilized lipase on RC-OX-EDA-GA	$4.7 \pm 0.17$	65

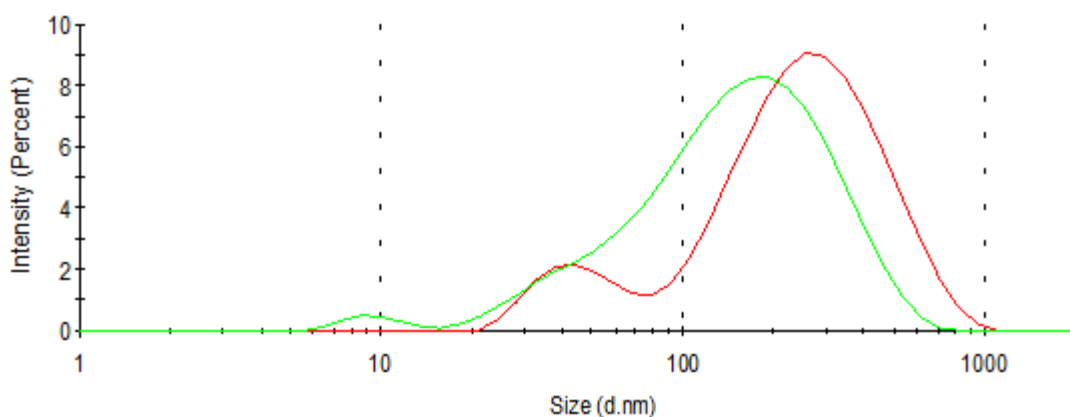


**Figure 3.25** Immobilized lipase stability



The spacer offers higher degrees of freedom, resulting in a positive effect on the rate of hydrolysis; indeed, the enzyme is allowed stretching flexibly and catching the substrate more easily.

Moreover, the aggregation behavior of lipase, which was evidenced both in solution and on the membrane surface, plays an important role on its activity. Indeed, it is reported in literature that the specific activity of aggregated *Candida rugosa* lipase is higher than that of the monomer indicating that the aggregation process may help the interfacial binding with the substrate [25]. This evidence was further investigated by evaluating the specific activity of free lipase after disaggregation. A lipase solution at 1 g/L concentration was filtered by using a 0.2  $\mu\text{m}$  cellulose acetate syringe filter. The applied mechanical pressure partially induced the protein disaggregation determining a reduction of its molecular size as confirmed by DLS results (figure 3.26). The specific activity of lipase before and after filtration was compared and results are reported in table 3.5. As can be noted, after a partial disaggregation, the specific activity of the enzyme is significantly reduced, confirming that the aggregation behavior of lipase has a positive effect on its performances.

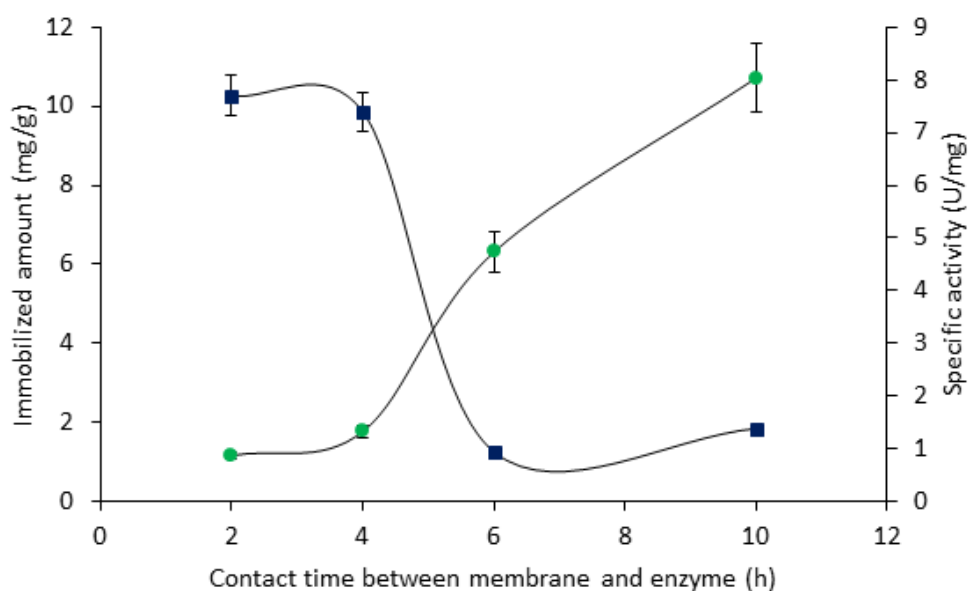


**Figure 3.26** Size distribution of lipase (1 g/l concentration) before (red) and after disaggregation (green).

**Table 3.5** Comparison between lipase activity before and after filtration.

Sample	Diameter size (nm)	Specific activity (U/mg)
Lipase before filtration	$48 \pm 15$ ; $298 \pm 155$	$7.2 \pm 0.21$
Lipase after filtration	$9.8 \pm 2.4$ ; $178.4 \pm 114.6$	$4.7 \pm 0.2$

The enzyme phosphotriesterase showed a behavior similar to lipase as the immobilization trend suggested the formation of multilayers on the membrane surface due to protein aggregation. The specific activity of immobilized phosphotriesterase on RC-OX-EDA-GA membrane was evaluated after different contact time between the membrane and the enzyme (figure 3.27). By increasing the contact time, and then the amount of immobilized enzyme, the specific activity decreased. In this case, the aggregation behavior of the protein and then the multilayer formation on the membrane surface had a negative effect on the enzyme performances. While, good results were obtained after 2 and 4 h of immobilization with an activity retention of 74 and 71 % respectively.



**Figure 3.27** Effect of multilayers formation on the specific activity of immobilized phosphotriesterase.

The performances of the immobilized protein G on RC-OX-EDA-GA membrane were evaluated with respect to the binding to human IgG. The antibody binding capacity of the protein G-immobilized membrane was  $40.2 \pm 3.6$  mg/g. Considering every protein G has three binding domains (the protein G immobilized amount was  $2.65 \pm 0.07$  mg/g), it can be known that every 1.14 binding domains captures one IgG molecule. Thus, after immobilization, the protein G binding capacity was preserved.

### 3.4 Conclusions

An understanding of the irreversible immobilization is important to tune appropriate immobilization conditions for the fabrication of bio-functional surfaces. Herein, the covalent immobilization of four different model proteins (bovine serum albumin, lipase from *Candida rugosa*, phosphotriesterase and protein G) on differently functionalized regenerated cellulose membranes was performed. The aggregation behavior of the proteins in solutions as a function of concentration was studied and it was correlated to the behavior of the proteins during immobilization. Based on the results obtained and discussed, several observations and conclusions can be made.

- For BSA and protein G, that didn't show aggregation phenomena in solution, the immobilization kinetic trends indicated that the saturation coverage was concentration independent. Moreover, their binding isotherms, parallel to the concentration axis over the concentration range studied, suggested a non-equilibrium irreversible process.
- AFM micrographs of BSA and protein G functionalized membranes give indication about the formation of monolayer, which reflect the oligomers formed in solution.
- In the case of lipase and phosphotriesterase, a high aggregation behavior in solution was observed and the membrane saturation coverage was not reached showing an unusual kinetics trend that suggested the formation of multilayer on the membrane surface.
- AFM micrographs of lipase functionalized membranes confirmed the presence of large aggregates that growth over time forming multilayer structure.

- Concluding: the aggregation behavior of proteins in solution has a significant influence on the protein layer formation on the RC surface.
- Finally, the bio-functionalized membranes preserved the biomolecules functional properties showing good performances with promising applications in biotechnology fields such as biocatalytic membrane reactor, biosensors, bio-hybrid systems and bio-separation.

---

**References**

- [1] Carter DC and He XM, Structure of human serum albumin, *Science* 249 (1990) 302-303
- [2] Tamara Topolai, Andreea Bodoki, Luminita Oprean, Radu Oprean, Bovine serum albumin interaction with metal complexes, *Clujul Medical* 87 (2014) 215-219
- [3] Swarup Roy, Review on Interaction of Serum Albumin with Drug Molecules, *Research and Reviews: Journal of Pharmacology and Toxicological Studies* 4 (2016) 7-16
- [4] Wojciech Bal, John Christodoulou, Peter J. Sadler, Alan Tucker, Multi-metal binding site of serum albumin, *Journal of Inorganic Biochemistry* 70 (1998) 33-39
- [5] Jian Yin, Wanzhi Wei, Xiaoying Liu, Bo Kong, Ling Wu, Shuguo Gong, Immobilization of bovine serum albumin as a sensitive biosensor for the detection of trace lead ion in solution by piezoelectric quartz crystal impedance, *Analytical Biochemistry* 360 (2007) 99–104
- [6] Zou, H. Luo, Qu., Zhou D, Affinity membrane chromatography for the analysis and purification of proteins, *J. Biochem. Bioph. Meth.*, 49 (2001) 199–240
- [7] Kochan J, Wu Y, Etzel M. Purification of bovine immunoglobulin G via protein G affinity membranes. *Ind Eng Chem Res* 35 (1996) 1150–5
- [8] Asta Makaraviciute, Almira Ramanaviciene, Site-directed antibody immobilization techniques for immunosensors, *Biosensors and Bioelectronics* 50 (2013) 460-471
- [9] S. Gupta, A. Bhattacharya, C.N. Murthy, Tune to immobilize lipases on Polymer Membranes:  
Techniques, Factors and Prospects, *Biocatalysis and Agricultural Biotechnology* 2 (2013) 171-190
- [10] L. Giorno, E. D'Amore, E. Drioli, R. Cassano, N. Picci. Influence of –OR ester group length on the catalytic activity and enantioselectivity of free lipase and immobilized in membrane used for the kinetic resolution of naproxen esters. *J. Catal.* 247 (2007) 194–200

- [11] Funda Kartal, Ali Kilinç, Suna Timur, Lipase biosensor for tributyrin and pesticide detection, *International Journal of Environmental Analytical Chemistry* 87 (2007) 715–722
- [12] Sarah D. Aubert, Yingchun Li, Frank M. Raushel, Mechanism for the Hydrolysis of Organophosphates by the Bacterial Phosphotriesterase, *Biochemistry* 43 (2004) 5707–5715
- [13] G. Vitola, R. Mazzei, E. Fontananova, E. Porzio, G. Manco, S.N. Gaeta, L. Giorno, Polymeric biocatalytic membranes with immobilized thermostable phosphotriesterase, *Journal of Membrane Science* 516 (2016) 144-151
- [14] Eman Ghanem, Frank M. Raushel, Detoxification of organophosphate nerve agents by bacterial phosphotriesterase, *Toxicology and Applied Pharmacology* 207 (2005) 459-470
- [15] B. Akerstrom, L. Bjorck, A physiological study of protein G, a molecule with unique immunoglobulin G-binding properties, *J. Biol. Chem.* 261 (1986) 10240-10247.
- [16] T. M. Stich, Determination of protein covalently bound to agarose supports using bicinchoninic acid, *Anal. Biochem.* 191 (1990) 343-346.
- [17] Peng-Cheng Chen, Xiao-Jun Huang, Zhi-Kang Xu, Utilization of a biphasic oil/aqueous cellulose nanofiber membrane bioreactor with immobilized lipase for continuous hydrolysis of olive oil, *Cellulose* (2014), 21, 407-416
- [18] E.Y. Chi, S. Krishnan, T.W. Randolph, J.F. Carpenter, Physical Stability of Proteins in Aqueous Solution: Mechanism and Driving Forces in Nonnative Protein Aggregation, *Pharm. Res.*, 20 (2003) 1325-1336.
- [19] B. Jachimska, M. Wasilewska, Z. Adamczyk, Characterization of Globular Protein Solutions by Dynamic Light Scattering, Electrophoretic Mobility, and Viscosity Measurements, *Langmuir* 24 (2008) 6866-6872.
- [20] G. Yohannes, S.K. Wiedmer, M. Elomaa, M. Jussila, V. Aseyev, M.L. Riekkola, Thermal aggregation of bovine serum albumin studied by asymmetrical flow field-flow fractionation, *Anal. Chim. Acta.* 675 (2010) 191-198

- [21] J.P. Derrick, D.B. Wigley, Crystal structure of a streptococcal protein G domain bound to an Fab fragment, *Nature* 359 (1992) 752-754.
- [22] R. Fernandez-Lafuente, C.M. Rosell, V. Rodriguez, C. Santana, G. Soler, A. Bastida, J.M. Guisán, Preparation of activated supports containing low pK amino groups. A new tool for protein immobilization via the carboxyl coupling method, *EnzymeMicrob. Tech.* 15 (1993) 546–550.
- [23] L. Betancor, F. Lopez-Gallego, A. Hidalgo, N. Alonzo-Morales, G. Dellamora-Ortiz Cesar Mateo, R. Fernandez-Lafuente, J.M. Guisan, Different mechanisms of protein immobilization on glutaraldehyde activated supports: Effect of support activation and immobilization conditions, *EnzymeMicrob. Tech.* 39 (2006) 877–882.
- [24] W. Plazinski, W. Rudzinski, A. Plazinska, Theoretical models of sorption kinetics including a surface reaction mechanism: A review, *Adv. Colloid Interfac.* 152 (2009) 2-13.
- [25] Y.C. Liou, A.G. Marangoni, R.Y. Yada, Aggregation behavior of *Candida rugosa* lipase, *Food Res. Int.*, 31(1998) 243-248.

**Chapter 4**

**Development of immuno-selective membranes for targeted interleukin-6 antigen capture, concentration and detection**



This chapter deals the development of immuno-selective membranes with immobilized specific antibody for the capture, recognition, concentration and subsequent detection of target interleukin analyte.

In particular, two strategies were developed for the realization of an immuno-affinity membrane with the aim to ensure some of the essential requirements of a bio-hybrid surface for immunosensor applications:

- The preservation of the biological activity of the bio-recognition element;
- The stabilization of the bio-element;
- The possibility of regeneration and reuse of the bio-element;
- A limited non-specific binding capacity.

The immuno-affinity can be exploited to isolate and capture specific target analytes taking advantages from one of nature's most optimized molecular recognition mechanisms, namely, the interaction between an antigen and its specific antibody [1], thus allowing a reliable and sensitive analysis [2], [3].

Interleukins are signaling cytokines that play a key role in regulating immune response but have also been implicated in the development and progression of numerous diseases including Alzheimer's [4], [5], dementia [6], and cancer [7]. They represent challenging analytes due to their low concentration in biological fluids or tissues [8], [9].

In this work, interleukin-6 (IL-6) was selected as model analyte to be captured as it plays an important role on inflammatory processes [10]. IL-6 is a multifunctional cytokine which acts on inflammation, acute-phase reaction, growth regulation and differentiation of various cell types [11]. An overexpression of IL-6 causes several diseases including inflammatory and autoimmune disorders, coronary artery disease, neurological disease, and gestational problems [12]. Elevated IL-6 levels have been observed in most types of cancer [13]. In healthy individuals, IL-6 is present at a very low concentration  $\leq 6 \text{ pg mL}^{-1}$  [14-16], making the earlier diagnosis of diseases a rather challenging task [17-19].

Because of its excellent properties such as biocompatibility, high hydrophilicity and low non-specific adsorption of proteins, commercial regenerated cellulose (RC) membrane was used for anti IL-6 antibody immobilization. The membrane was functionalized following the same protocol described in chapter 3 to allow protein G covalent binding. Then, the protein G-coupled membrane was used for the site-specific anti-IL 6 antibody immobilization taking advantages from the ability of protein G to bind Fc portion of

antibodies with high affinity and spatial orientation. The immuno-affinity membrane as produced was used for IL-6 capturing. In a second strategy, after binding to protein G, the anti IL-6 antibody was cross-linked with glutaraldehyde (GA). The capture efficiency to IL-6 of both immuno-affinity membranes was compared and the possibility of antibody regeneration and reuse was evaluated. Moreover, a quenching step with glycine was performed on the immuno-affinity membranes and it was optimized to minimize the non-specific analyte binding on the membrane surface.

Finally, the immuno-affinity membrane cross-linked with GA was integrated with an electrochemical detection system, based on organic electrochemical transistors (OECTs), and it was used for a pre-concentration step of targeted IL-6 with the aim to increase the sensitivity of the system. In the last few years, OECTs are gaining increasing interest for applications in biosensing since they can be operated at low voltage in aqueous environment, enabling the transmission of signals between biological systems and electronics [20], [21]. Moreover, simple processing and versatile geometry facilitate OECTs integration into lab-on-a-chip devices [22], however, in some cases, they suffer from sensitivity and selectivity.

#### 4.1 Materials and chemicals

Flat sheet ultrafiltration regenerated cellulose membranes (RC) were used as matrix for antibody immobilization and they were purchased from Millipore (Italy).

Recombinant protein G from *Streptococcus sp.* expressed in *E. Coli* was used for oriented antibody immobilization and it was purchased from BioVision (Vinci-Biochem, Italy). The protein retains only IgG binding domains and lacks the albumin, cell wall and cell membrane binding regions ensuring the maximum IgG binding capacity.

Human IgG, sodium periodate  $\geq 99.8$  %, ethylenediamine, glutaraldehyde, and glycine were obtained from the Sigma-Aldrich Chemical Co (Italy).

Sodium borohydride  $> 98$  %, Pierce™ BCA Protein Assay Kit, NuPAGE™ Novex® Bis-Tris Gel System, Mark12™ Unstained Standard protein were obtained from Thermo Fischer Scientific. SilverQuest™ Staining Kit was obtained from Invitrogen.

Anti Interleukin-6 (IL-6) mouse monoclonal Antibody (mAb, 6B4 IGH 54) was purchased from Enzo Life Science (3V Chimica S.r.l., Italy). Anti IL-6 polyclonal antibody (FITC conjugated) was obtained from Biorbyt (D.B.A. S.r.l., Italy). Cymax™ Mouse IL-6 ELISA kit with sensitivity  $< 1.138$  pg/ml was obtained from AbFrontier (Vinci-Biochem, Italy).

## 4.2 Experimental procedures

### 4.2.1 Protein G immobilization

RC membranes were functionalized by wet chemical treatment in order to introduce aldehyde reactive groups and, after that, the protein G was covalently immobilized on the membrane surface by means of a spacer as described in chapter 3. Briefly, the RC membrane (diameter 47 mm) was cut into discs of 1 cm diameter and reacted with a 0.2 % w/w sodium periodate solution for 7h. Then, the spacer was introduced by means of a reaction with a 5 % w/w ethylenediamine solution for 15 h and subsequent activation with a 5 % w/w glutaraldehyde solution for 2 h.

The functionalized membrane discs were equilibrated in a 50 mM phosphate buffer solution (PBS) pH 7 and incubated with a 1 mg/ml protein G solution. The discs were allowed to react up to 3 h in order to reach the surface saturation coverage of the membrane. Finally, the bio-functionalized membranes were treated with 50 mM sodium borohydride in NaOH at 4°C for 15 minutes, in order to stabilize the covalent linkage. The bio-functionalization procedure has been described in more detail in chapter 3.

#### 4.2.1.1 Binding capacity of immobilized protein G

Adsorption isotherm for protein G-coupled membrane (RC-PG) was carried out using commercial human IgG (hIgG) as model ligand. The adsorption experiments were conducted in static condition by immersing the protein G-coupled membrane in the antibody solutions. The hIgG was reconstituted in PBS solution (25 mM, pH 5.8) containing 150 mM NaCl. The membrane discs (0.785 cm<sup>2</sup>) were equilibrated in the same buffer and put in contact with 1 ml of hIgG solution at different initial concentration (0.1, 0.2, 0.5 and 1.0 g/L). The hIgG solution was allowed to react with the membrane up to 7 h under mild stirring to determine the equilibrium binding capacity. Then the membranes were washed with 25 mM PBS pH 5.8 containing 150 mM NaCl in order to remove the unbounded hIgG and the samples of wash were collected.

The amount of bounded hIgG was calculated from the mass balance between the initial, final and washing solutions according to equation 1:

$$C_i V_i = C_f V_f + C_{ws} V_{ws} + m \quad (1)$$

Where,  $m$  is the mass of immobilized protein,  $C$  and  $V$  are the concentration and volume, respectively; the subscripts  $i$ ,  $f$  and  $ws$  refer to the initial, final, and washing solutions, respectively. The protein concentration was determined by using the BCA assay based on a standard curve constructed by using pure hIgG. The binding capacity of the membrane was defined as amount of hIgG adsorbed ( $\mu\text{g}$ ) per surface area ( $\text{cm}^2$ ) of membrane.

Moreover, based on the assumption that each protein G has three binding sites for IgG [23], the efficiency of protein G - hIgG binding was also determined as the percentage of the number of hIgG molecules bounded to protein G binding sites relative to the total number of molecules of hIgG binding sites available according to equation 2:

$$\text{hIgG binding efficiency} = \frac{\text{molecules of hIgG bounded}}{\text{total number of molecules of hIgG binding sites}} \times 100 \quad (2)$$

#### 4.2.1.2 Analysis of the equilibrium adsorption data

The hIgG adsorption isotherm on the protein G-coupled membrane was studied based on the Langmuir isotherm equation (3). It is generally used to describe sorption of small solutes from liquid solutions, however it has been also extensively used for the interpretation of experimental data related to the binding behavior of biomolecules in affinity adsorbents due to its usefulness in the determination of the maximum capacity of the adsorbent [24], [25]. It mainly assumes that the adsorption sites on the surface are homogeneous and independents (monovalent binding) and a monolayer of adsorbed proteins is formed:

$$q = \frac{Q_{max} C}{k_D + C} \quad (3)$$

where  $q$  is the amount of bounded IgG ( $\mu\text{g}$ ) per surface area ( $\text{cm}^2$ ) of membrane,  $C$  is the concentration of hIgG in solution at the equilibrium (M),  $k_D$  represents the dissociation constant of the system (M),  $Q_{max}$  corresponds to the maximum binding capacity of the protein G – coupled membrane ( $\mu\text{g}/\text{cm}^2$ ).

$Q_{max}$  and  $k_D$  can be determined from a linearized form of Eq. (3), represented by Eq. (4):

$$\frac{1}{q} = \left( \frac{k_D}{Q_{max}} \right) \frac{1}{C} + \frac{1}{Q_{max}} \quad (4)$$

It will have a straight line with a slope of  $k_D/Q_{\max}$  and an intercept of  $1/Q_{\max}$  when  $1/q$  is plotted against  $1/c$ .

#### 4.2.2 Strategies for anti IL-6 antibody bioaffinity immobilization

Two different strategies were used to immobilize the anti IL-6 antibody, with and without antibody stabilization, as illustrated in figure 4.1. The procedure is described below.

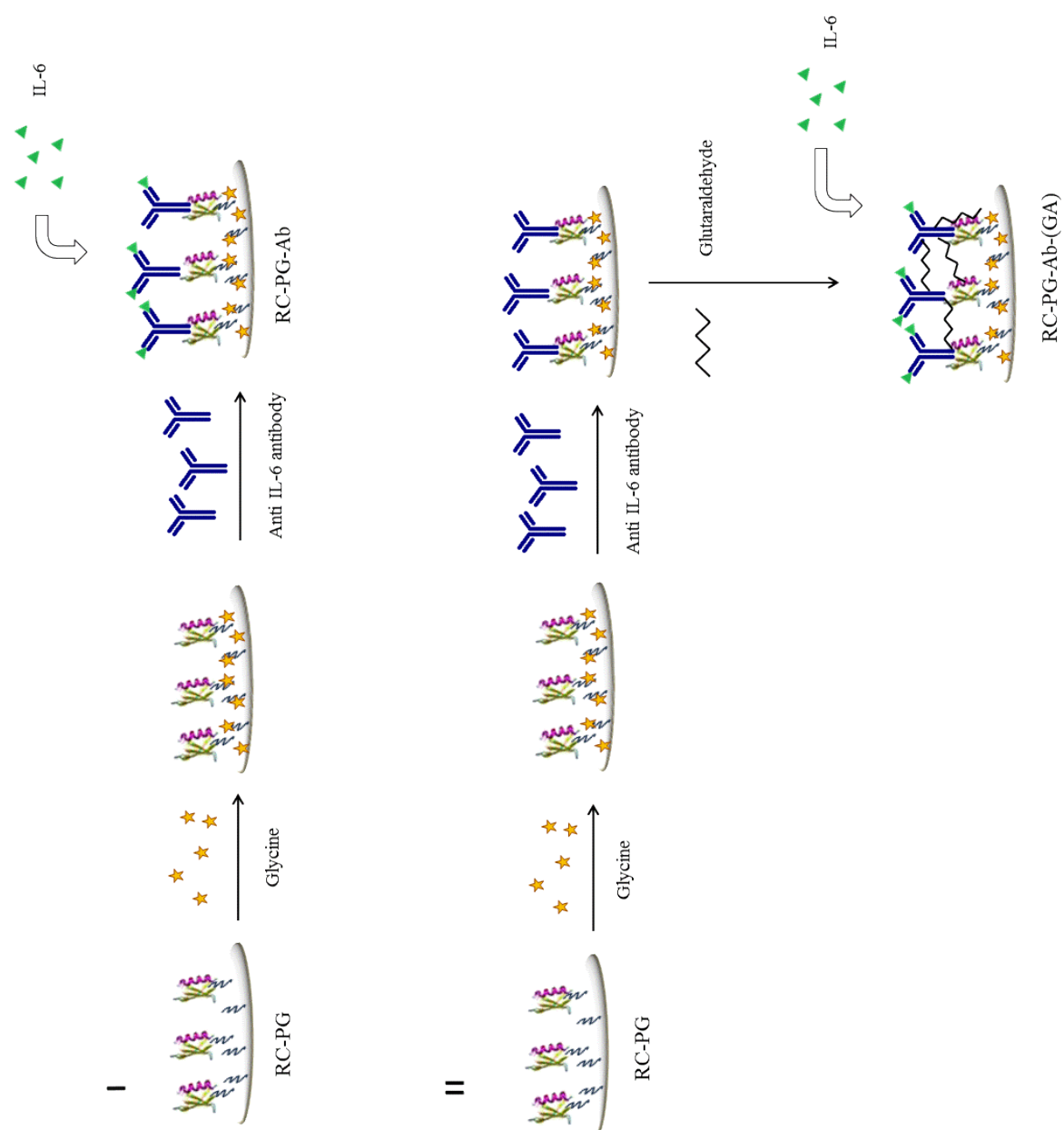
The RC membrane was cut into discs of diameter 6 mm using a paper punch and bio-functionalized with protein G as described before. The RC-PG discs were placed into a multiwall plastic plate and incubated with a 1 M glycine solution prepared in a 50 mM PBS pH 7.0, in order to quench the unreacted aldehyde groups, minimizing the IL-6 non-specific binding. After the quenching step, discs were washed with 50 mM PBS pH 7.0 and then they were equilibrated in PBS (25 mM, pH 5.8) containing 150 mM NaCl before antibody binding. Thereafter, 100  $\mu$ l of anti IL-6 antibody diluted in 25 mM phosphate buffer pH 5.8 containing 150 mM NaCl as 0.5 mg/ml was loaded on the membrane at 4 °C overnight. After incubation, the resulting immuno-affinity membranes named RC-PG-Ab were washed thrice with PBS and stored at 4 °C for the subsequent IL-6 capture (figure 4.1-I).

In the second strategy, the anti IL-6 antibody, after its immobilization, was stabilized by means of a glutaraldehyde (GA) cross linker (figure 4.1-II). The membrane discs were reacted with a 2 % v/v glutaraldehyde solution for 2 h at room temperature and then washed thoroughly with distilled water to remove the excess of reagent. Thereafter, the membranes were treated with 50 mM sodium borohydride in NaOH at 4°C for 15 min, in order to stabilize the linkage. The discs were washed with distilled water and stored in PBS at 4 °C for further usage. The immuno-affinity membranes obtained were named RC-PC-Ab-(GA).

##### 4.2.2.1 Quenching step optimization

The glycine quenching procedure was optimized in order to eliminate the IL-6 non-specific binding on the membrane surface. The RC-PG membrane discs were reacted with the same concentrated glycine solution (1 M) by varying the incubation time (2 h, 5 h and 14 h). After quenching, the membranes were washed with PBS and incubated with IL-6 solutions at similar concentrations that would have been used for the capturing test (31,

250, 500 pg/ml). The amount of non-specifically bounded IL-6 was determined indirectly by using the ELISA test as explained in the following section.

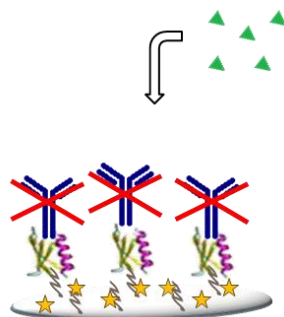


**Figure 4.1** Schematic representation of the two strategies used for anti IL-6 antibody bioaffinity immobilization without chemical cross-link I) and with glutaraldehyde cross-link II)

### 4.2.3 Evaluation of IL-6 capturing by the immuno-affinity membranes

The immuno-affinity membranes (RC-PG-Ab and RC-PG-Ab-(GA)) were used as capture matrix for the targeted IL-6 antigen. Besides, the RC-PG membrane blocked with glycine was used as blank to evaluate the specificity of the antigen binding (figure 4.2). All the experiments were conducted in static conditions by simply immersing the membrane in the protein solutions. The RC-PG-Ab and RC-PG-Ab-(GA) membranes as well as the blank were incubated with 250  $\mu$ l of IL-6 antigen at different initial concentrations (31, 250, 500 pg/ml) for 2 h at room temperature (pH 7). After incubation, membrane discs were rinsed three times with PBS (pH 7). All the solutions were collected for quantitative analysis.

The specificity of RC-PG-Ab and RC-PG-Ab-(GA) membranes towards the targeted IL-6 antigen was further assessed by using BSA as unrelated protein. The immuno-affinity membranes were incubated with a BSA solution (4  $\mu$ g/ml) for 2 h. The membranes were rinsed with 50 mM PBS, pH 7 and then they were immersed into a desorption buffer (0.1 M glycine HCl buffer pH 2.5). The original and final BSA solutions (after incubation with the membranes) and the solutions of desorption were analyzed by SDS-PAGE under reducing conditions using the same procedure described in section 4.2.4.



**Figure 4.2** Schematic representation of the membrane used as blank to evaluate the specificity of IL-6 binding

#### 4.2.3.1 ELISA tests

The antigen concentration in the initial, final and washing solutions was measured by immunoenzymatic ELISA method. The amount of captured IL-6 was determined by the mass balance between the solutions (Eq. 1) and it was defined as pg of IL-6 per  $\text{cm}^2$  of membrane. The IL-6 used for binding experiments was a mouse recombinant IL-6 standard

provided by the kit and also used for the construction of the standard curve. Experiments were performed in triplicate and the SD was calculated. The capture efficiency (CE %) was calculated according to the following equation:

$$CE = \frac{\text{Amount of captured IL-6}}{\text{Amount of IL-6 in initial solution}} \times 100 \quad (5)$$

#### 4.2.3.2 Confocal analysis

The RC-PG-Ab-(GA) membrane discs, after incubation with IL-6 antigen solutions (30, 250 and 500 pg/ml) were washed with PBS and further incubated overnight at 4°C with anti IL-6 antibody FITC-conjugated (1:200 dilution in 50 mM PBS, pH 7) to form a sandwich complex (RC-PG-Ab-(GA)-Ag-Ab-FITC) on the membrane surface. As negative controls, RC virgin membrane, without bio-functionalization, and RC-PG-Ab-(GA) membrane (without the incubation step with IL-6) were simultaneously treated with anti IL-6 antibody FITC-conjugated. After the incubation, all the samples were vigorously washed with PBS to remove unbound antibody, mounted in microscope slides and observed with a Confocal Laser Scanning Microscope CLSM (Fluoview FV300, Olympus, Milan, Italy).

#### 4.2.4 Desorption tests and membrane reuse

Since antigen antibody-complexes are disrupted at low pH, the possibility of regenerating the immuno-affinity membranes after IL-6 capturing was evaluated. The experiments were conducted in static condition by immersing the membrane in the elution buffer and protein solutions.

The RC-PG-Ab-Ag and RC-PG-Ab-(GA)-Ag membrane discs were immersed and stirred into 250 µl of 0.1 M glycine HCl buffer pH 2.5 for two consecutive cycles of 30 minutes each at room temperature. Samples were collected and the pH was adjusted to 7.4 using 9 µl of 1 N NaOH. The composition of the solutions was analyzed by SDS-PAGE under reducing conditions carried out on a Mini-Cell System (X Cell Sure Lock™ Mini-Cell, Invitrogen), with 4% stacking and 12% resolving gel formula. After gel running, the gel was silver stained with the silver stain kit (sensitivity ~ 0.3 ng). The presence of IL-6 in the samples was checked by using ELISA test.



After IL-6 desorption, the RC-PG-Ab-(GA) membranes were used for a second IL-6 capturing cycle. The operating procedure and the method of quantification were the same described in the section 4.2.3.

#### *4.2.5 IL-6 pre-concentration and detection*

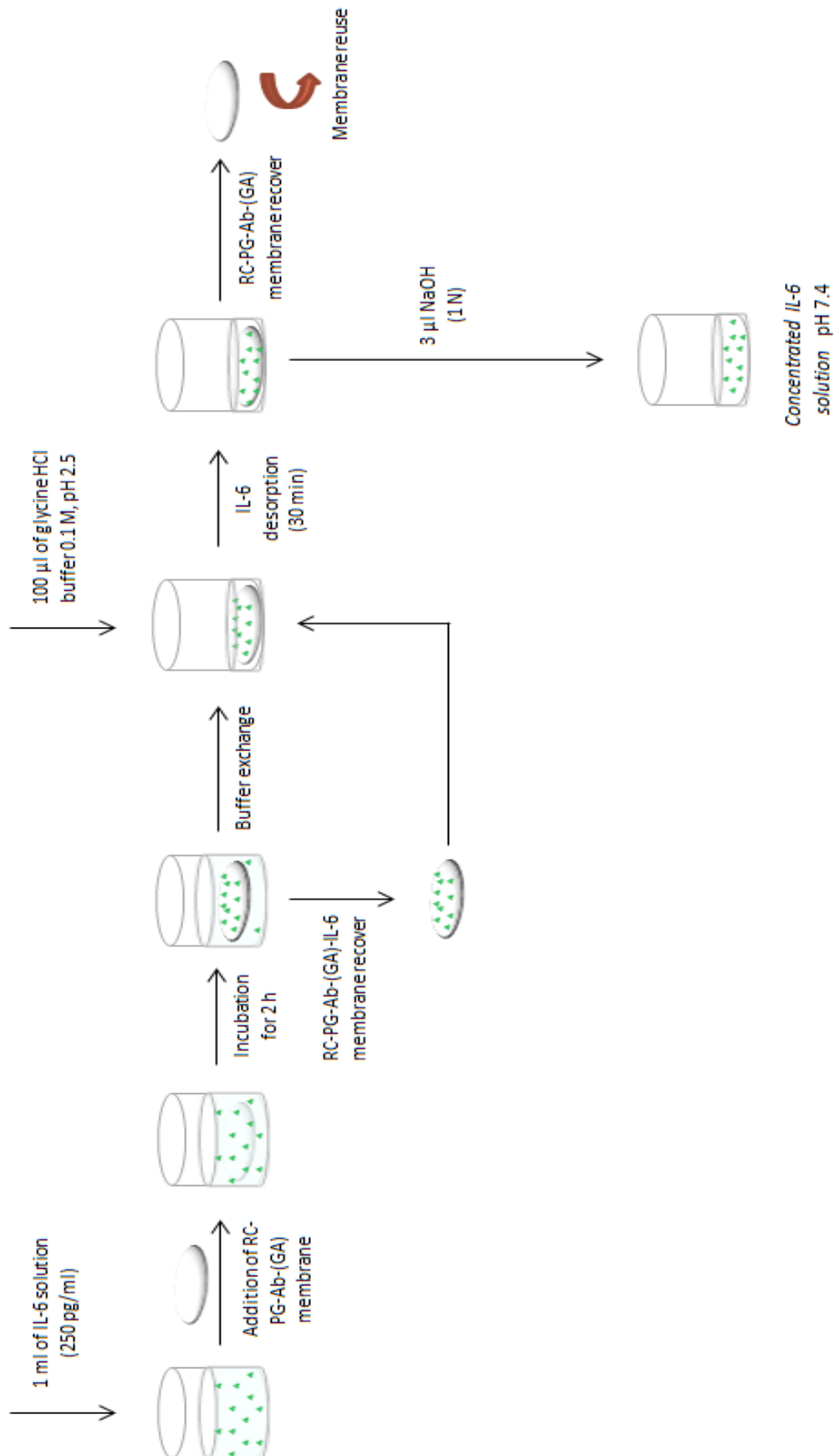
The RC-PG-Ab-(GA) membrane was integrated with a detection system based on organic electrochemical transistor (OECT) equipped with an electrode functionalized with specific anti IL-6 antibody. The membrane was used for a pre-concentration step of the targeted IL-6 with the aim to increase the detection sensitivity of the system. All the experiments were conducted in static conditions by simply immersing the membrane in the solutions. This part of the work was carried out in collaboration with the Institute of Materials for Electronics and Magnetism (CNR-IMEM, Parma-Italy) and the Institute for the Study of Nanostructured Materials (CNR-ISMN, Bologna-Italy) that have been involved on the development of the detection system and electrical measurements.

##### *4.2.5.1 Method for IL-6 pre-concentration*

The method used for IL-6 pre-concentration consisted on the IL-6 capturing by the immuno-affinity membrane and the subsequent IL-6 desorption by using a smaller volume of buffer.

A schematization of the procedure is given in figure 4.3. The RC-PG-Ab-(GA) membrane (1 cm<sup>2</sup> surface area) was incubated with 1 ml of IL-6 solution at the initial concentration of 250 pg/ml for 2 h. After IL-6 capturing, the RC-PG-Ab-(GA)-IL-6 membrane was recovered and rinsed with 50 mM PBS, pH 7. Then, the membrane was transferred into 100 µl of glycine HCl buffer, pH 2.5 for 30 minutes for IL-6 desorption and concentration. Assuming that all the IL-6 antigen has been captured and desorbed, the concentration factor can be obtained from the ratio between the volume of the initial IL-6 solution and the volume of the desorption solution. In this case, a theoretical concentration factor of 10 is expected.

The IL-6 concentrated solution was subsequently used for the IL-6 electrochemical detection as described below, while the RC-PG-Ab-(GA) membrane was stored for further reus



**Figure 4.3** Schematic representation of the method used for IL-6 pre-concentration by using the immuno-affinity membrane

#### 4.2.5.2 Organic Electrochemical Transistor (OECT) for IL-6 detection

After the pre-concentration step, the IL-6 was electrochemically detected using a detection system based on organic electrochemical transistors (OECTs). An OECT consists of a conducting polymer channel, ion permeable, in contact with an electrolyte solution that has a gate electrode immersed in it (figure 4.4 – a). The conducting polymer is the poly (3, 4-ethylenedioxythiophene), doped with polystyrene sulfonate (PEDOT:PSS).

Based on a schematic representation proposed by Tarabella et al., [26], in figure 4.4 is reported the device structure (a) and working principle (b and c) of an OECT with a PEDOT:PSS active layer. The OECT channel is defined by the contact region between the electrolyte (an aqueous solution), confined into a polymethylsiloxane (PDMS) well, and the PEDOT:PSS film deposited on a substrate; the external part acts as source and drain electrodes. (figure 4.4 – a). The figure 4.5 shows the different components of the OECT used for the electrical measurements.

Being PEDOT:PSS a hole conductor, upon the application of a negative drain-source voltage ( $V_{ds}$ ) holes drift within the transistor channel generating a drain-source current ( $I_{ds}$ ) (*on* state, figure 4.4 – b). When a positive gate-source voltage ( $V_{gs}$ ) is applied (figure 4.4 – c), the electrolyte ions redistribute in solution and part of the cations ( $M^+$ ) of the electrolyte enter the PEDOT:PSS channel and de-dope it according to equation (6), thereby decreasing  $I_{ds}$  (*off* state), due to the smaller number of holes available for conduction [26]:



On the contrary, when  $V_{gs} = 0$  V is applied ion diffusion occurs from the PEDOT:PSS to the electrolyte, thus increasing the number of conducting holes. This is named as doping process, as in this case  $I_{ds}$  increases. As a consequence, the drain current  $I_{ds}$  decreases when  $V_{gs} > 0$  V is applied and increases when  $V_{gs}$  is set again to 0 V.

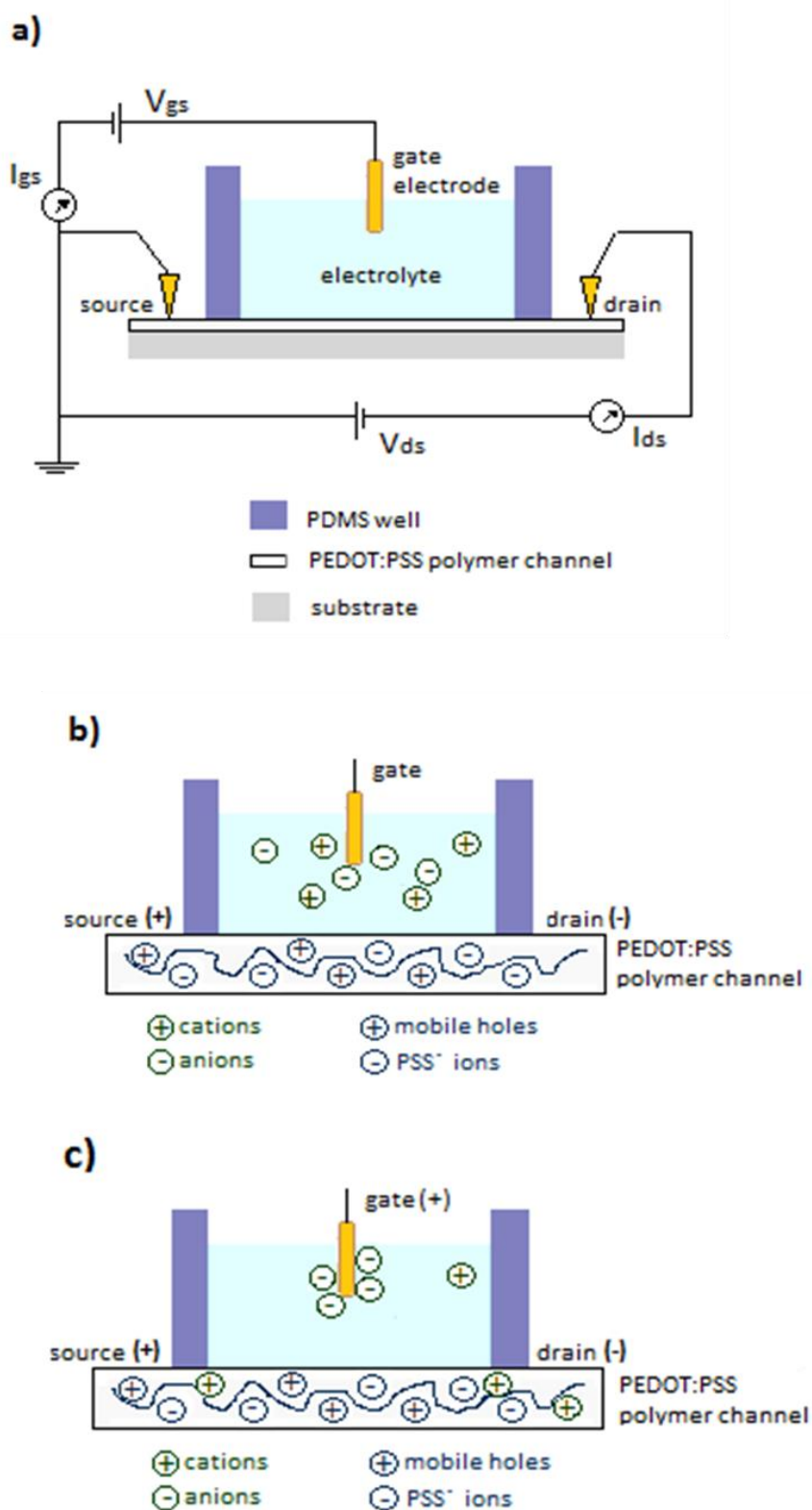
The OECT response is expressed as the current modulation:

$$\Delta I / I_0 = |I_{ds,off} - I_{ds,0} / I_{ds,0}| \quad (7)$$

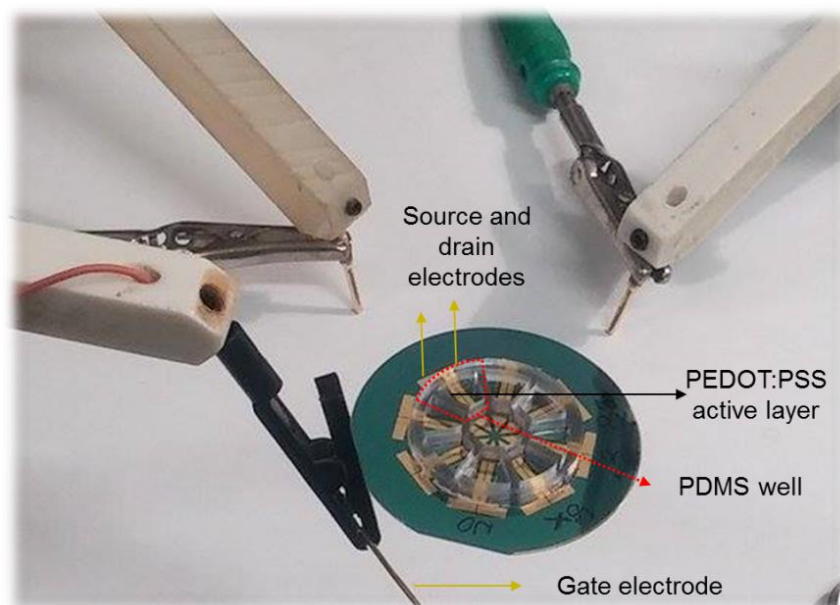
where  $I_{ds,off}$  is the *off* source-drain current (gate voltage,  $V_{gs} > 0$ ) and  $I_{ds,0}$  is the *on* drain-source current (gate voltage,  $V_{gs} = 0$ ).

In this study, a gold electrode functionalized with a specific anti IL-6 antibody was used as the gate electrode (Ab-gate electrode) in the OECT device. The Ab-gate electrode was

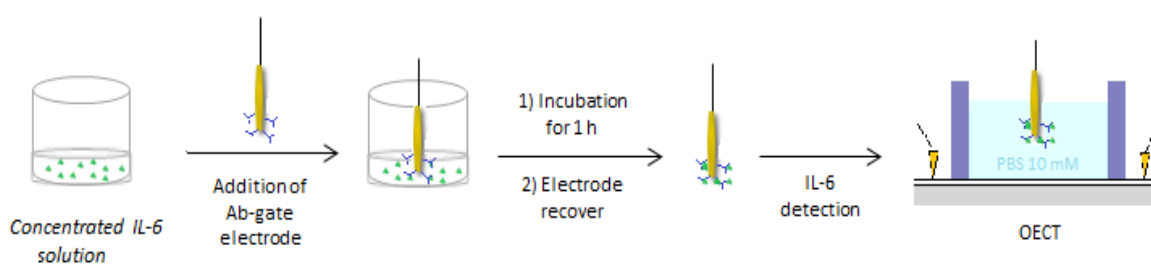
incubated with the concentrated IL-6 solution for 1 h in order to allow the antigen-antibody binding. Then, it e was immersed in the electrolyte solution (PBS 10 mM) and the OECT modulation was measured (figure 4.6) by varying  $V_{gs}$  between 0 and 0.4 V and keeping the drain-source voltage ( $V_{ds}$ ) constant at  $-0.1$  V. In order to make a comparison between the OETC response before and after IL-6 binding, a bare Au-gate electrode and an Ab-gate electrode were used as references and the OECT modulation was measured in the same operating conditions.



**Figure 4.4** (a) Device structure and electrical circuit of a PEDOT:PSS organic electrochemical transistor (OECT); (b) and (c) OECT working principle [26]



**Figure 4.5** Components of the OECT used for the electrical measurements



**Figure 4.6** Schematic of the procedure used for electrochemical IL-6 detection by using the antibody-functionalized gate electrode and the IL-6 concentrated solution.

### 4.3 Results and discussions

#### 4.3.1 Antibody binding capacity of protein G-coupled membrane

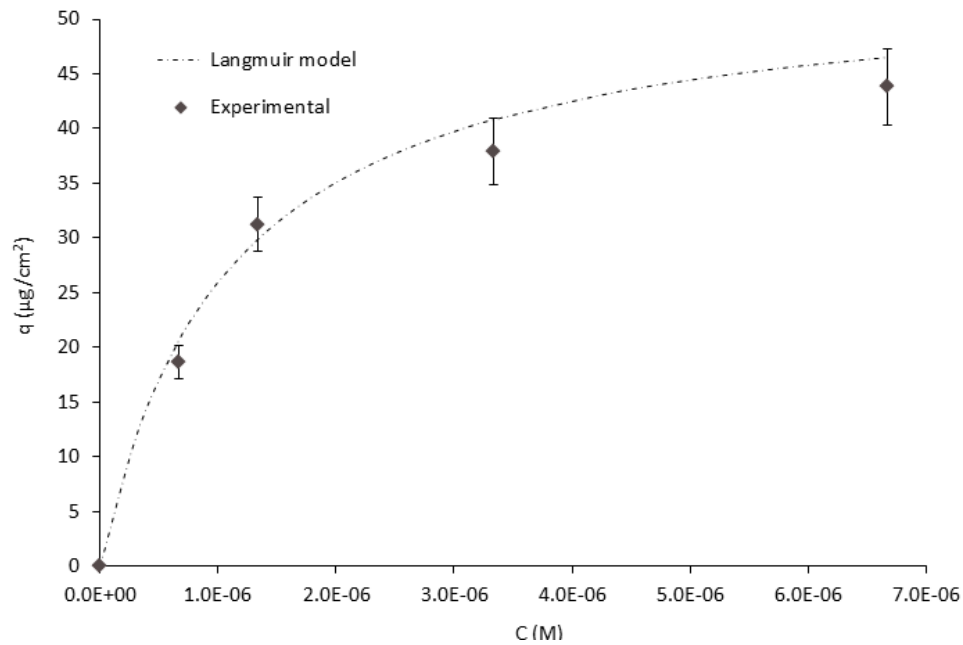
Protein G was reacted with the membrane until surface saturation coverage was achieved, then a stable monolayer of protein was covalently bounded as demonstrated in chapter 1 and [27]. The maximization of the protein G density on the membrane surface is

important for ensuring a high level of antibody binding resulting in improvement of the subsequent antigen capturing [28].

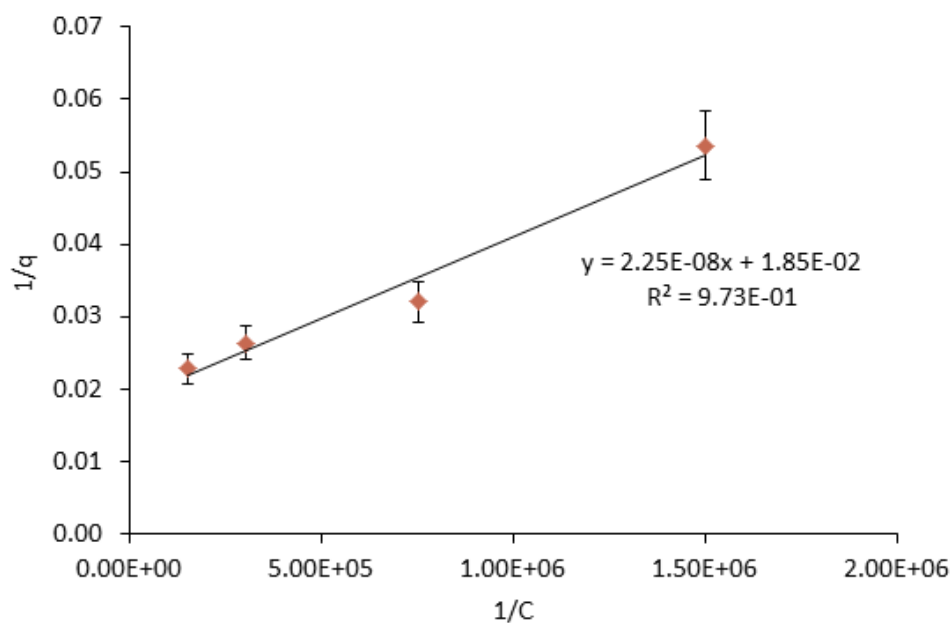
Before investigating the application of specific antibody for the capture of target antigen, the binding capacity of the protein G-coupled membrane was evaluated using a commercial human IgG as model ligand and adsorption isotherm was constructed.

The experimental results are reported in figure 4.7 and data were fitted in a Langmuir type isotherm. The binding capacity ( $Q_{\max}$ ) and the dissociation constant ( $k_D$ ) were determined from the plot of  $1/q$  versus  $1/C$  (figure 4.8), which corresponds to  $54.05 \mu\text{g}/\text{cm}^2$  and  $1.08 \times 10^{-6} \text{ M}$  (0.16 mg/ml), respectively, at the concentrations investigated. The binding capacity of the RC-PG membrane calculated by using Eq. (4) was closer to the experimental result ( $43.8 \pm 3 \mu\text{g}/\text{cm}^2$  at  $C = 1 \text{ mg/ml}$  in figure 4.7). As can be seen in figure 4.4, the plot of  $1/q$  versus  $1/C$  showed a linear isotherm over the entire concentration range studied with high  $R^2$  value (0.973) indicating that the adsorption behavior was consistent with the Langmuir adsorption model. Moreover, the validation of the applicability of Langmuir equation was verified by the Scatchard plot [29], by plotting  $q/C$  versus  $q$ . Results (figure 4.9) evidenced a linear dependence indicating a zero cooperativity (independent interaction) between the protein and the binding sites [24].

Moreover, the binding capacity of the RC-PG membrane was further analyzed to obtain information about the utilization efficiency of the binding domains of the covalent immobilized protein G. Considering the amount of immobilized protein G ( $2.9 \mu\text{g}/\text{cm}^2$ ), the calculated hIgG binding efficiency (Eq. (2)) was very high (88 %) indicating that almost all the protein G binding domains can be exploited for antibody binding.

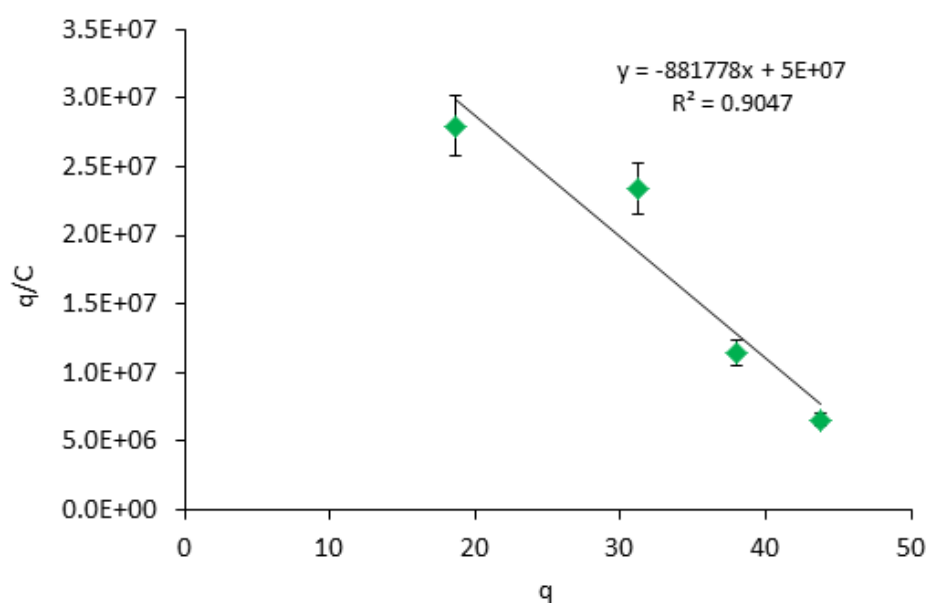


**Figure 4.7** Adsorption isotherm for commercial human IgG onto Protein G-coupled membrane



**Figure 4.8** Linear Langmuir isotherm for hIgG adsorption on protein G-coupled membrane





**Figure 4.9** Scatchard plot

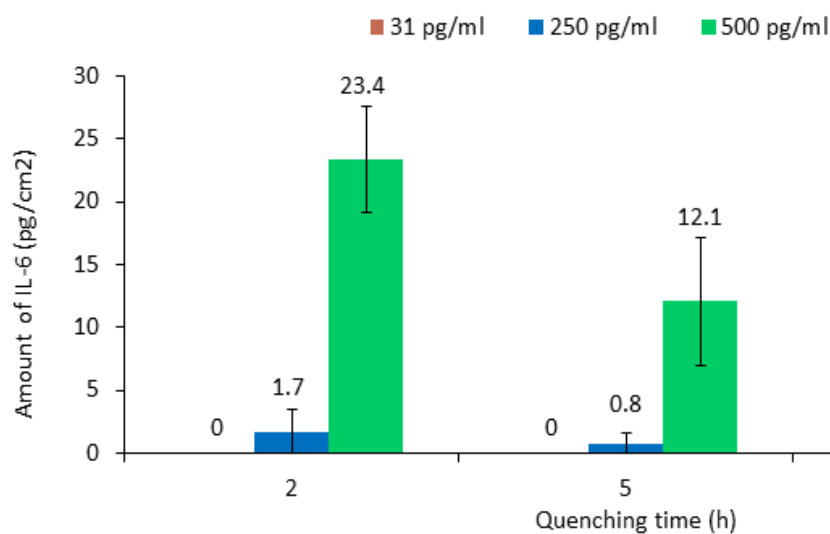
### 4.3.2 Immuno-affinity membranes preparation and IL-6 capturing

#### 4.3.2.1 Quenching step optimization

After the membrane chemical functionalization and the protein G immobilization, some unreacted aldehyde groups may remain free for binding with other molecules. Therefore, before using the immuno-affinity membranes for IL-6 capturing, the glycine quenching step was optimized in order to limit the non-specific binding of IL-6 on the membrane surface.

The RC-PG membranes were quenched with 1 M glycine solution for different times (2 h, 5 h and 14h). The results of the influence of quenching time on the amount of antigen non-specifically bounded at different antigen initial concentrations (31, 250 and 500 pg/ml) are shown in figure 4.10.

Results indicated that in order to eliminate the non-specific binding formation a quenching time of 14 hours was needed. Indeed, no IL-6 binding formation was detected for all initial concentrations of IL-6 used. This result may ensure the specificity of IL-6 capturing when anti IL-6 antibody is used even at high IL-6 concentration.

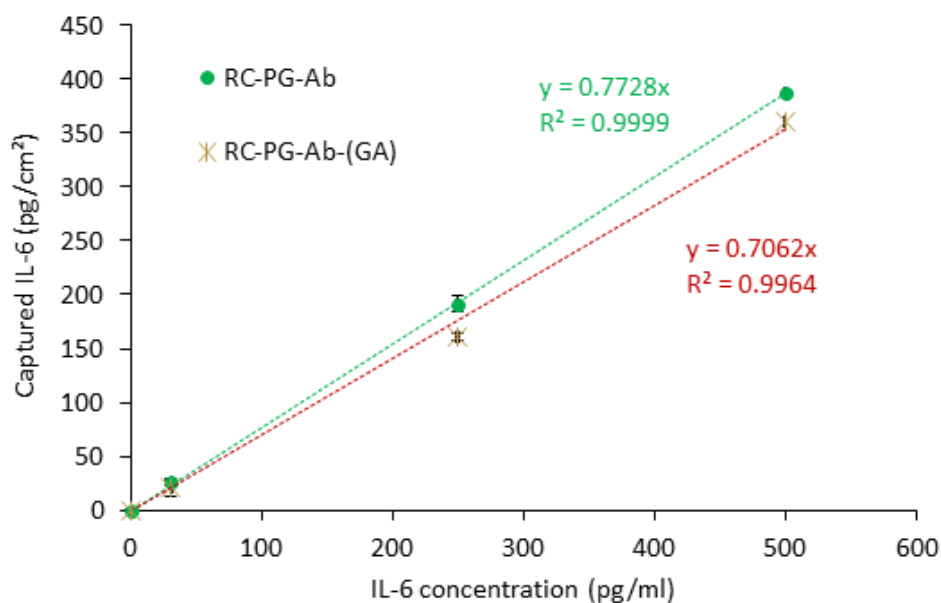


**Figure 4.10** Quenching step optimization. Influence of glycine quenching time on the amount of IL-6 ( $\text{pg}/\text{cm}^2$ ) non-specifically bounded on the membrane surface (RC-PG) at different IL-6 initial concentrations ( $\text{pg}/\text{ml}$ ).

#### 4.3.2.2 Quantification of IL-6 capturing

After the quenching step optimization, the anti IL-6 specific antibody was immobilized on the RC-PG membranes by the two strategies illustrated in figure 1. The RC-PG-Ab and the cross-linked RC-PG-Ab-(GA) membranes were used for IL-6 capturing and the amount of antigen captured from both surfaces was quantified and compared. Results are shown in figure 4.11 (a summary of mass balance results obtained from ELISA quantification experiments is also given in table 4.1). As can be seen from figure 4.6, for both membranes, the amount of captured IL-6 increased linearly as increasing the initial IL-6 concentration.

The amount of captured IL-6 by the RC-PG-Ab-(GA) membrane was slightly lower when compared to the RC-PG-Ab membrane probably due to the cross-linker (GA) that could binds the Fab regions of antibody and might affect the antibody capturing sites (for example, reducing the number of available capturing sites).

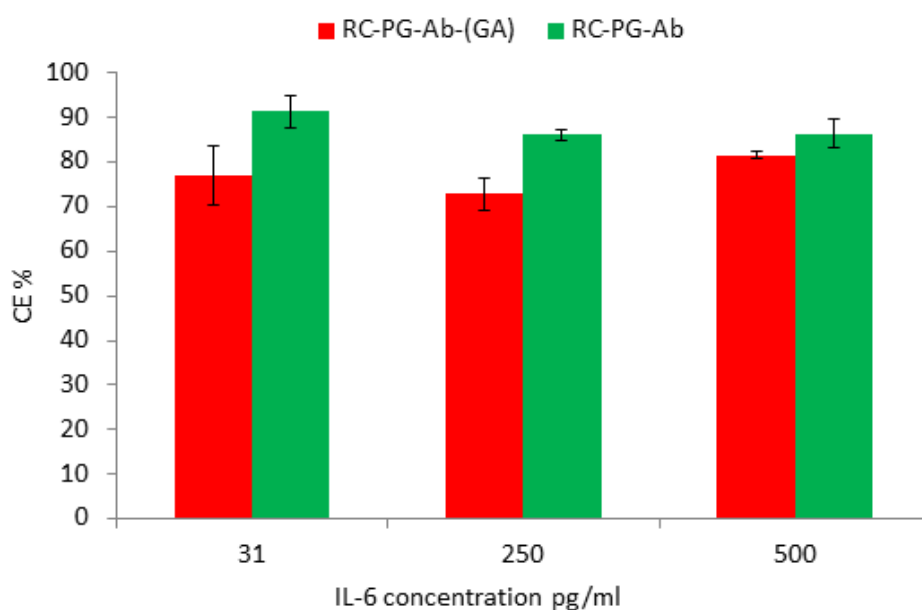


**Figure 4.11** Amount of IL-6 captured by the RC-PG-Ab and RC-PG-Ab-(GA) membranes as a function of initial IL-6 concentration

The possible reaction mechanism involves the reaction of aldehyde groups of GA with amino groups of antibody and protein G (generally lysine) to form imine bond between protein G-antibody and antibody-antibody molecules. An IgG molecule contains 83 lysine groups on its structure [30] and any of these groups can be involved on the reaction affecting the antigen recognition process. In this study the use of GA as cross linker permitted to preserve almost entirely the antibody capturing site. This is an interesting outcome also considering that different papers report high reduction of antigen binding using other commonly bifunctional cross-linkers as dimethylpimelimidate (DMP) and bis(sulfosuccinimidyl)suberate (BS3) to link Fc binding proteins (protein A, protein G) and antibody. In some cases, a substantially loss in antibody activity was noticed [28], [31] with lower antigen binding, even if maintaining the analytical performance (concentration range of detection) of the sensor surface [28].

Figure 4.12 shows the capture efficiency (CE%) of RC-PG-Ab-(GA) and RC-PG-Ab membranes with IL-6 solutions at different concentrations. The results indicated that the membranes had a high ability to bind the antigen also at very low concentration (31 pg/mL) permitting to bind up to 91% of IL-6 initial concentration. This very high capture efficiency of immuno-affinity membranes is a key factor to develop a detection technology in which the concentration of targeted molecules is very low. This membrane ability can be exploited for antigen pre-concentration (e.g. on integrated miniaturized systems) to

increase sensitivity and immunosensor performances when low abundant compound have to be detected (as demonstrated in the last section). Besides, as the local concentration of the antigen was maximized, showing a linearity in response to the variation of the initial concentration, the immuno-affinity membranes as prepared have a great potential to be used directly for solid-state analytical immunoassays and immunosensors giving also the possibility to avoid the use of signal amplification.



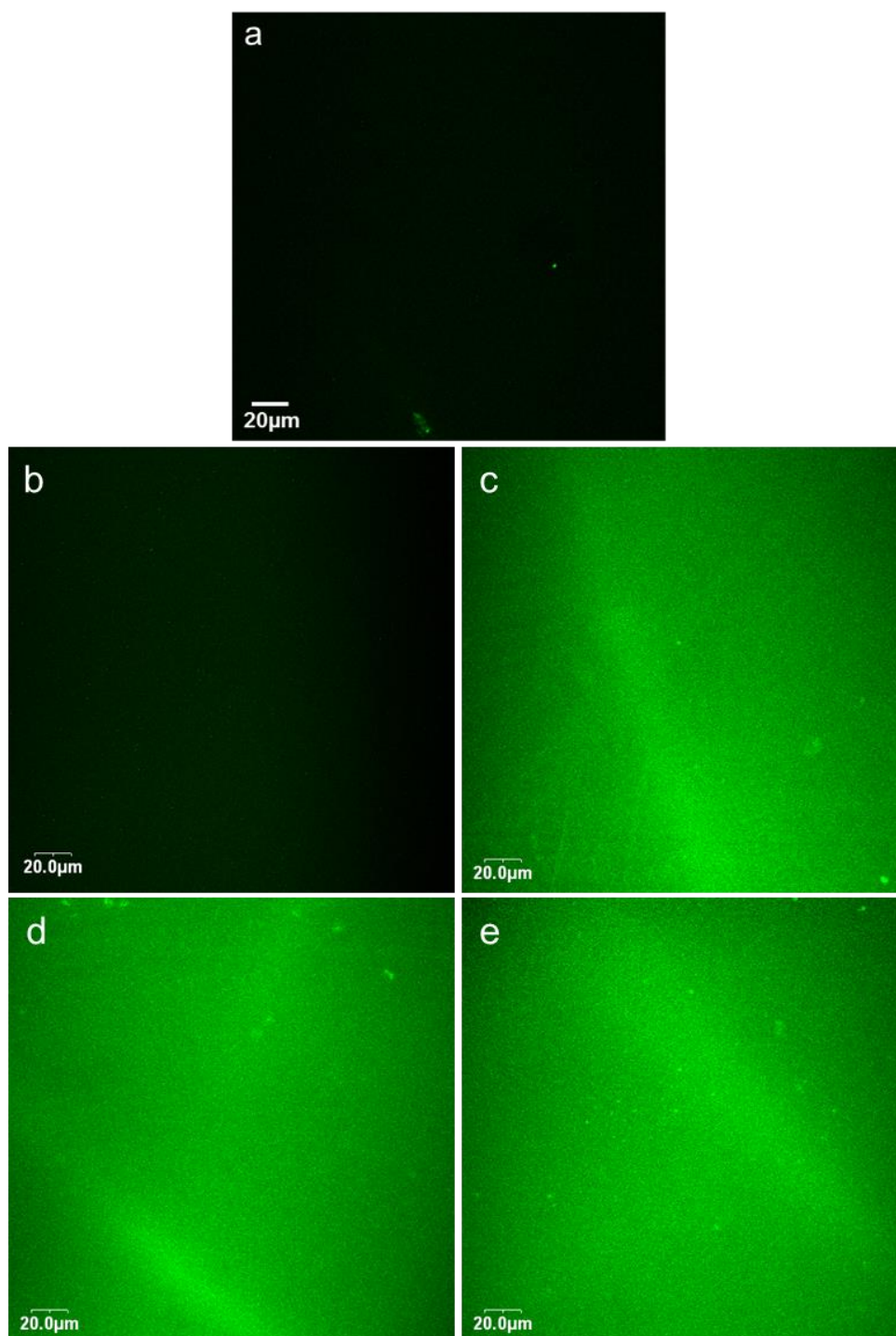
**Figure 4.12** Capture efficiency of RC-PG-Ab and RC-PG-Ab-(GA) membranes at different IL-6 initial concentrations.

#### 4.3.2.3 Visualization of IL-6 capturing

The IL-6 capturing by the RC-PG-Ab-(GA) membrane was also assessed by confocal laser scanning microscope after the incubation with the IL-6 solution at the concentrations of 31, 250 and pg/ml, and following a specific reaction with the anti-IL-6 antibody FITC conjugated. RC virgin membrane and RC-PG-Ab-(GA) membrane (without the incubation step with IL-6) were also treated and used as negative controls in order to evaluate the non-specific binding of the labeled antibody.

While a negligible fluorescence was detected on the control membranes (figure 4.13 (a) and (b)), a bright fluorescence was visualized on all the RC-PG-Ab-(GA)-Ag membranes

(figure 4.13 (c), (d) and (e)), confirming the efficient antigen capturing of the bio-functionalized membranes.



**Figure 4.13** Confocal laser scanning microscopy (CLSM) images of RC virgin membrane (a), RC-PG-Ab-(GA) membrane (b) and RC-PG-Ab-(GA)-Ag membranes incubated with IL-6 at 31 pg/ml (c), 250 pg/ml (d) and 500 pg/ml (e), all treated with anti IL-6 antibody FITC-conjugated.

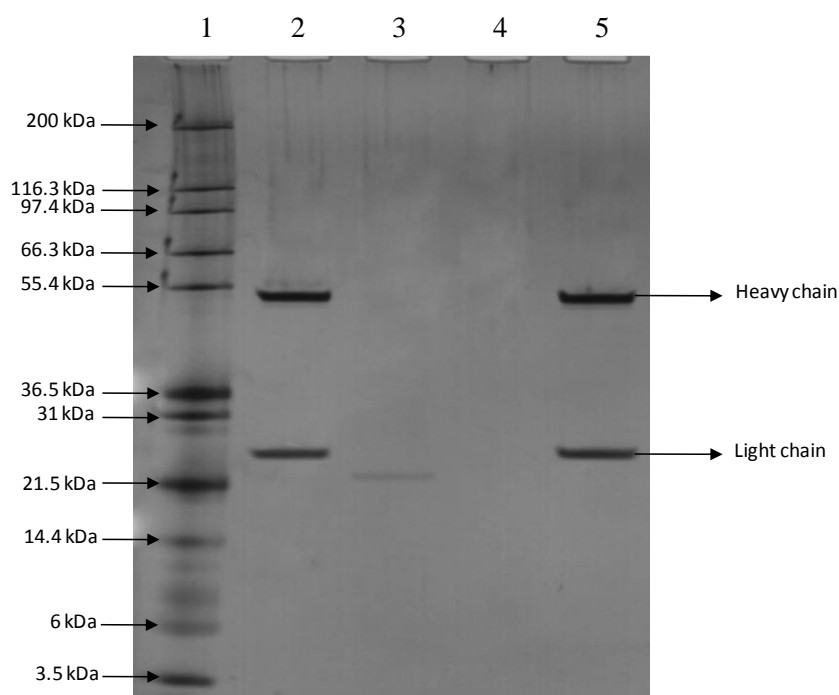
#### 4.3.2.4 Desorption tests and membrane reuse

One of the most important aspects on the development of immunosensors is the possibility of antibody regeneration to realize reusable diagnostic devices and to limit costs. For this purpose, the antibody regeneration and the immuno-affinity membranes reuse were evaluated by performing two cycles of acidic desorption on the RC-PG-Ab-Ag and RC-PG-Ab-(GA)-Ag membranes in order to remove the captured IL-6, and then a second IL-6 injection and capturing cycle. Samples of desorption solutions were analyzed by SDS-PAGE under reducing conditions and by ELISA test. SDS-PAGE results (figure 4.14) showed that after the first desorption cycle, the anti IL-6 specific antibody was released from the RC-PG-Ab-Ag membrane (fig. 5 – line 5), instead, no antibody release was observed from the RC-PG-Ab-(GA)-Ag membrane (fig. 5 – line 4). Since the amount of IL-6 captured is low ( $\sim 0.1$  ng at 500 pg/ml) and it is beyond the sensitivity of the staining method ( $\sim 0.3$  ng), the presence of IL-6 was not detected by the SDS-PAGE (figure 4.14) and it was checked by the ELISA test. Results indicated that, after the first desorption cycle, the IL-6 was fully removed from the membranes surface (table 4.1).

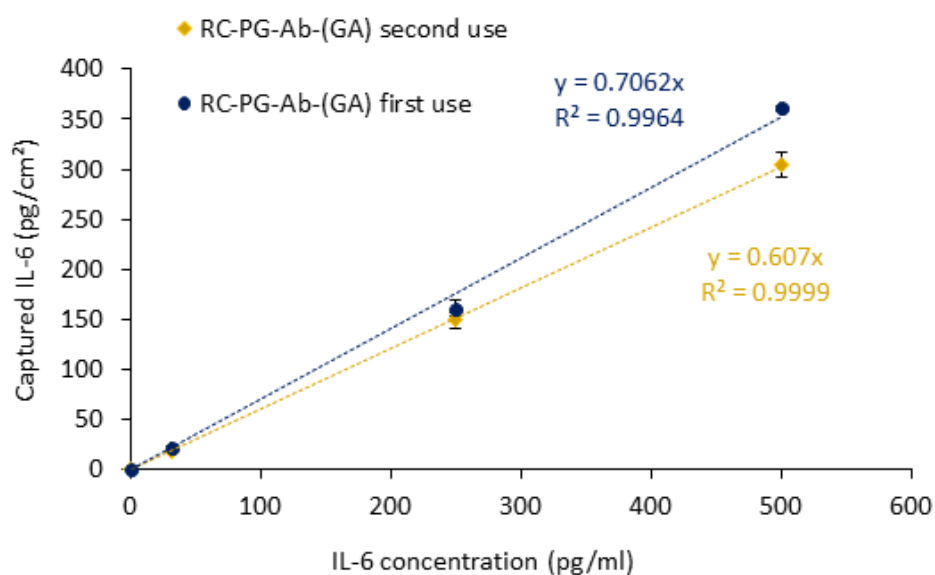
The antibody desorption from the RC-PG-Ab-Ag membrane can be explained by taking in to account the type of binding with protein G. Indeed, even if the affinity interaction is strong, in certain drastic conditions such as very low pH, the protein G-antibody complex can be also dissociated limiting the antibody multiple use. On the other hand, we found that after glutaraldehyde treatment the antibody layer became very stable and no dissociation was observed. In addition, it is important to point out that the reduction step with  $\text{NaBH}_4$ , after GA treatment, played an important role on the antibody stabilization. Indeed, bypassing this step, it was observed antibody release even if in low amount.

The RC-PG-Ab-(GA)-Ag membrane was then used for the second IL-6 capturing cycle and results are shown in figure 4.15. The amount of captured IL-6 increased linearly as increasing the IL-6 initial concentration and it was comparable to the first use, only a slightly reduction was observed. Also the capture efficiency was still high (figure 4.16) and similar to the one of the first use.

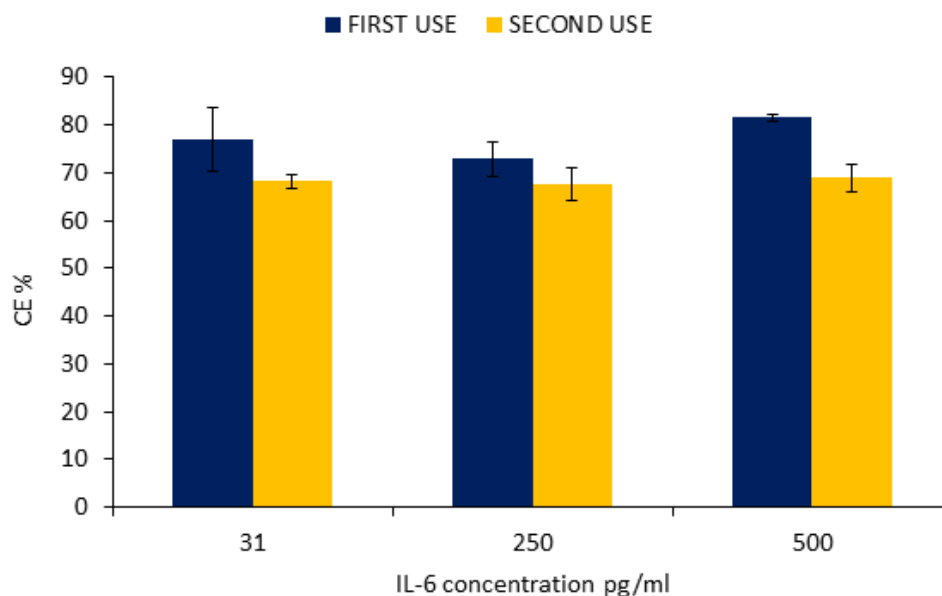
Form these results, it was concluded that the RC-PG-Ab membrane was not suitable for repeated use as the specific antibody was also removed. On the contrary, the cross-link method with GA allowed antibody stabilization and membrane reuse by also preserving the antibody binding capacity.



**Figure 4.14** SDS-PAGE under reducing condition of the samples after the first cycle of acid desorption. 1 – wide range molecular weight marker (1:20 dilution). 2 – anti IL-6 antibody used as standard (65 ng). 3 – mouse IL-6 used as standard (13 ng). 4 – RC-PG-Ab-(GA)-Ag desorption. 5 – RC-PG-Ab-Ag desorption.



**Figure 4.15** Amount of IL-6 captured by the RC-PG-Ab-(GA) membrane for repeated use as a function of initial IL-6 concentration



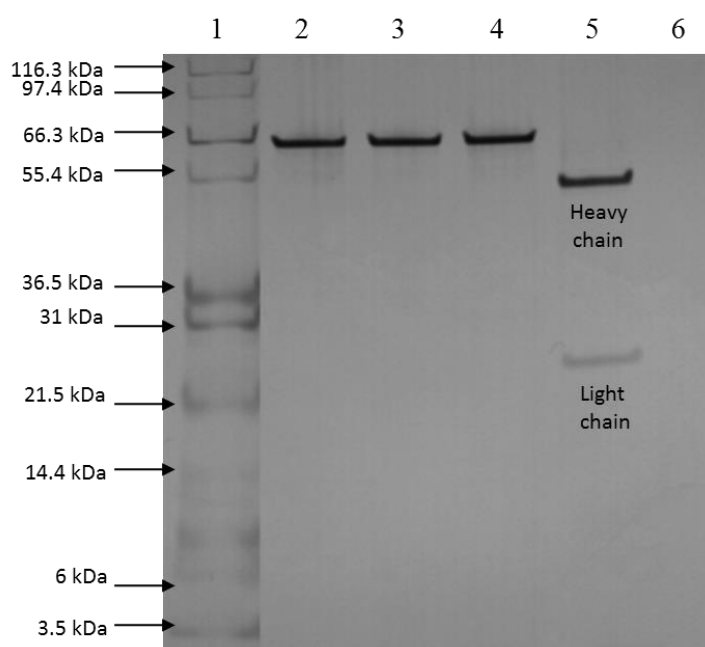
**Figure 4.16** Capture efficiency of RC-PG-Ab-(GA) membrane for repeated use, at different IL-6 initial concentration.

**Table 4.1** Summary of mass balance results obtained from ELISA quantification experiments

Immuno-affinity membrane	IL-6 initial concentration (pg/ml)	IL-6 captured amount (pg)	Amount of IL-6 desorbed - I cycle (pg)	Amount of IL-6 desorbed - II cycle (pg)
RC-PG-Ab-(GA)_FIRST USE	31	6.0 ± 0.5	5.7 ± 0.2	ND
	250	45.5 ± 2.2	45.0 ± 1.2	ND
	500	102.0 ± 0.9	100.1 ± 1.7	ND
RC-PG-Ab-(GA)_SECOND USE	31	5.3 ± 0.1		
	250	42.2 ± 2.1		
	500	86.1 ± 3.7		
RC-PG-Ab	31	7.3 ± 0.2		
	250	54.1 ± 0.4		
	500	109.4 ± 2.2		



Finally, the specificity of RC-PG-Ab and RC-PG-Ab-(GA) membranes towards the targeted IL-6 antigen was further demonstrated by using BSA as unrelated protein. Results are shown in figure 4.17. The BSA band of the original and final solutions (after incubation with the immuno-affinity membranes) showed the same intensity (line 2, 3 and 4). Moreover, the BSA band was not detected in the desorption solutions (line 5 and 6). Results indicated that neither specific nor non-specific binding between the BSA and IgG occurred, further confirming the specificity of the developed immuno-affinity membranes to the targeted IL-6 antigen.



**Figure 4.17** SDS-PAGE under reducing condition of the samples after BSA non-specific adsorption tests on RC-PG-Ab and RC-PG-Ab-(GA) membranes. 1 – wide range molecular weight marker (1:20 dilution). 2 – BSA initial solution. 3 – BSA final solution after incubation with RC-PG-Ab membrane. 4 – BSA final solution after incubation with RC-PG-Ab-(GA) membrane. 5 – RC-PG-Ab\_BSA desorption. 6 – RC-PG-Ab-(GA)\_BSA desorption.

### 4.3.3 Preliminary results on IL-6 detection

The RC-PG-Ab-(GA) membrane showed both a high antigen capture ability and the possibility of selective IL-6 desorption. Thus, it was used as concentrator for IL-6 and it was integrated with a detection system based on OECT in order to increase the detection sensitivity. Indeed, previous studies, conducted at the CNR-IMEM, showed a limit of sensitivity, for IL-6 detection, in the concentration order of  $\sim 2$  ng/ml, that is out of the physiologically-relevant range ( $\sim 3$ -300 pg/ml [14],[32]).

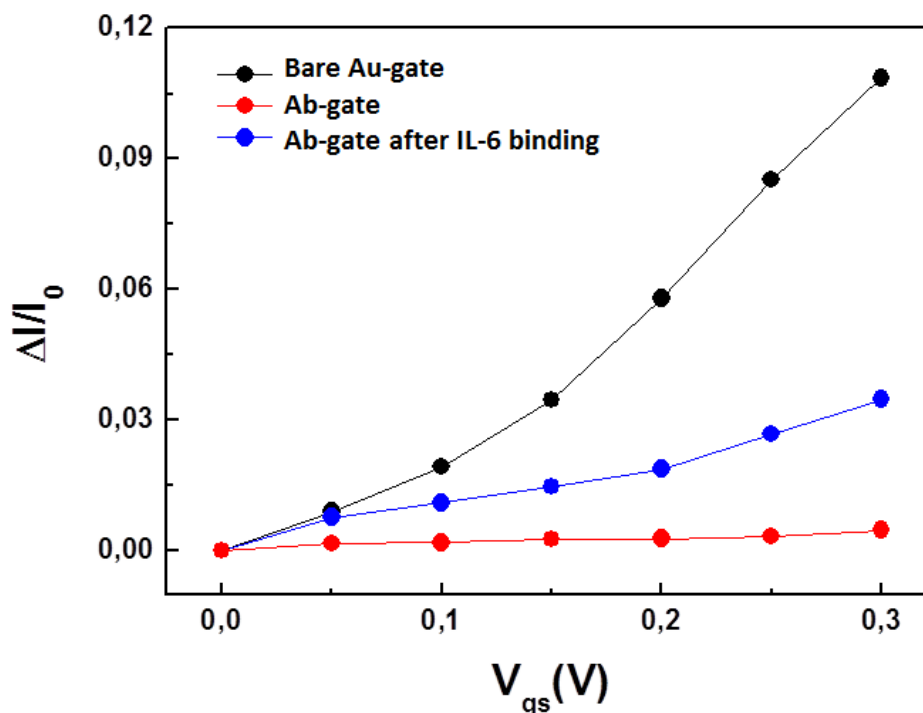
The concentration of the antigen was obtained by the IL-6 capturing by the RC-PG-Ab-(GA) membrane and the subsequent IL-6 desorption in a smaller volume of buffer, for a theoretical concentration factor of 10 (as described in section 4.2.5). The concentrated IL-6 solution was incubated with the gate electrode (Ab-gate) for allowing antibody-antigen binding and the electrode was immersed in the electrolyte solution for the electrochemical IL-6 detection (figure 4.6). Moreover, in order to have a comparison between the OECT response before and after IL-6 binding, a bare Au-gate electrode was used as a reference (blank) to check the effect of the antibody on the OECT response, and an Ab-gate electrode was used as a reference to check the OECT response after IL-6 binding.

The figure 4.18 shows the source-drain current modulations of the OECT using the three gate electrodes in the temporal order:

1. Bare Au-gate
2. Au-gate with immobilized antibody (Ab-gate)
3. Ab-gate after IL-6 binding.

The bare Au-gate electrode displays a higher modulation throughout the  $V_{gs}$  range used. While, the Ab-gate electrode displays the lower modulation and the Ab-gate electrode after IL-6 binding displays a modulation that is between the two reference electrodes. The lower modulation of the Ab-gate electrode can be expected due to the presence of the antibody layer that shields the potential applied to the electrode, resulting in a gate bias drop at the electrode-electrolyte interface. On the other hand, after IL-6 binding the OECT response increases. It could be due to a charge exchange between the antibody and the antigen that decreases the gate bias drop at the electrode-electrolyte interface. Thus, a substantial difference of the OECT response with and without the targeted IL-6 was obtained.

These preliminary results demonstrated the possibility of using the immuno-affinity membrane developed for IL-6 pre-concentration to improve the sensitivity of the OECT system of around one order of magnitude.



**Figure 4.18** OECT response. Comparison between OECT modulation ( $\Delta I/I_0$ ), as a function of gate voltage ( $V_{gs}$ ), using bare Au-gate electrode (black), Ab-gate electrode (red) and Ab-gate electrode after IL-6 binding (blue).

#### 4.4 Conclusions and general considerations

This work aimed to develop RC immuno-affinity membranes with the characteristics of selectivity, stability and reusability to be used for the specific capture and recognition of target antigen. A detailed characterization of the membranes developed was performed and they were tested, in static conditions, as immuno-selective interfaces for the capture, recognition, concentration and subsequent detection of IL-6 antigen. Two different strategies were used for the development of the immuno-affinity membranes. The RC membranes were bio-functionalized with protein G and the resulting bio-hybrid membranes were characterized in terms of antibody binding capacity. The protein G-coupled membranes were quenched with glycine (in order to minimize non-specific binding), and they were successfully used for the specific anti IL-6 antibody oriented

immobilization. In the second strategy, the immobilized specific antibody was cross-linked with glutaraldehyde. The antigen capture ability of both immuno-affinity membranes was evaluated and compared. Moreover, the cross-linked membrane was used as IL-6 concentrator and it was integrated with an OECT for IL-6 electrochemical detection. Based on the results obtained and discussed, several observations and conclusions can be made:

- The membrane bio-functionalized with the protein G showed a high antibody binding efficiency of 88 % with a maximum binding capacity of 43.8  $\mu\text{g}/\text{cm}^2$ .
- The immuno-affinity membranes, prepared by the two different strategies, efficiently captured the IL-6 antigen even at very low IL-6 concentration (31 pg/ml) with a CE up to 91 %. They also revealed a linear relationship between the amount of the captured IL-6 and the initial IL-6 concentration.
- The optimization of glycine quenching step allowed to eliminate the antigen non-specific binding on the membrane surface.
- Interestingly, the cross-link method with GA did not affect the antigen binding capacity and it promoted the antibody stabilization and the membrane reuse with comparable performances to the first use.
- Finally, the immuno-affinity membrane cross-linked with GA was integrated with an electrochemical detection system and was used to increase the sensitivity of detection by an IL-6 pre-concentration step showing promising results.

In conclusion, the developed immuno-affinity membranes fulfill the key requirements for a bio-functional interface on biosensing application, demonstrating the possibility of a reliable application for immunosensors and immunoassays. Moreover, the high capture efficiency of both protein G-coupled membrane and immuno-affinity membranes could be also exploited in affinity separation processes (for antibody and/or antigen separation and purification). In this case, the use of membranes could represent an alternative to classical chromatographic column, taking advantages of combining the selectivity of affinity interactions with the high productivity of filtration membranes (shorter diffusion times, lower mass transfer resistance due to convective flow, rapid processing).

---

**References**

- [1] Mariuzza, R. A., Immunologie, D., Pasteur, I.; Cedex, P. The Structural Basis of AntigenAntibody Recognition. *Annu. Rev. Biophys. Biophys. Chem.*, 1987, 16
- [2] Phillips, T.M., Wellner, E., Detection of cerebral spinal fluid-associated chemokines in birth traumatized premature babies by chip-based immunoaffinity CE, *Electrophoresis*, 2013, 34
- [3] Sanchez, F.G., Diaz, A.N., Herrera, R.G., San Jose, L.P., Development and characterisation of an immunoaffinity chromatographic column for the on-line determination of the pesticide triclopyr, *Talanta*, 2007, 71
- [4] Sokolova, A., Hill, M. D., Rahimi, F., Warden, L. A., Halliday, G. M., Shepherd, C. E., Monocyte Chemoattractant Protein-1 Plays a Dominant Role in the Chronic Inflammation Observed in Alzheimer's Disease *Brain Pathol.* 2009, 19
- [5] Llano, D. A., Li, J. H., Waring, J. F., Ellis, T., Devanarayan, V., Witte, D. G., Lenz, R. A., Cerebrospinal Fluid Cytokine Dynamics Differ Between Alzheimer Disease Patients and Elderly Controls, *Alzheimer Dis. Assoc. Disord.* 2012, 26
- [6] Angelopoulos, P., Agouridaki, H., Vaiopoulos, H., Siskou, E., Doutsou, K., Costa, V., Baloyiannis, S. I., Cytokines in Alzheimer's Disease and Vascular Dementia, *Int. J. Neurosci.* 2008, 118
- [7] Allen, C., Duffy, S., Teknos, T., Islam, M., Chen, Z., Albert, P. S., Wolf, G., Van Wales, C. Clin., Nuclear Factor- $\kappa$ B-Related Serum Factors as Longitudinal Biomarkers of Response and Survival in Advanced Oropharyngeal Carcinoma, *Cancer Res.* 2007, 13
- [8] Anderson, N. L., Anderson, N. G., The Human Plasma Proteome History, Character, and Diagnostic Prospects *Mol. Cell. Proteomics* 2002, 1
- [9] Kindt J. T., Luchansky M. S., Qavi A. J., Lee S.H., Bailey R. C., Subpicogram Per Milliliter Detection of Interleukins Using Silicon Photonic Microring Resonators and an Enzymatic Signal Enhancement Strategy, *Anal. Chem.* 2013, 85

- 
- [10] Scheller J., Chalaris A., Schmidt-Arras D., Rose-John S., The pro- and anti-inflammatory properties of the cytokine interleukin-6, *Biochimica et biophysica acta*, 2011, 1813
- [11] Deckert F., Legay F., Development and validation of an IL-6 immuno-receptor assay based on surface plasmon resonance. *J Pharm Biomed Anal.*, 2000, 23
- [12] Hong D.S., Angelo L.S., Kurzrock R., Interleukin-6 and its receptor in cancer: implications for translational therapeutics, *Cancer* 2007, 110
- [13] Łukaszewicz M., Mroczko B., Szmitkowski M., Clinical significance of interleukin-6 (IL-6) as a prognostic factor of cancer disease, *Pol Arch Med Wewn* 2007, 117
- [14] Riedel F., Zaiss I., Herzog D., Gotte K., Naim R., Hormann K., Serum levels of interleukin-6 in patients with primary head and neck squamous cell carcinoma, *Anticancer Research*, 2005, 25
- [15] Malhotra R., Patel V., Vaque' J. P., Gutkind J. S., Rusling J. F., Ultrasensitive Electrochemical Immunosensor for Oral Cancer Biomarker IL-6 Using Carbon Nanotube Forest Electrodes and Multilabel Amplification, *Anal. Chem.* 2010, 82
- [16] Nousari H.C., Kimyai-Asadi A., Anhalt G.J., Elevated serum levels of interleukin-6 in paraneoplastic pemphigus, *Journal of Investigative Dermatology*, 1999, 112
- [17] Yanga T., Wanga S., Jin H., Baoa W., Huang S., Wang J., An electrochemical impedance sensor for the label-free ultrasensitive detection of interleukin-6 antigen, *Sens. Actuat. B*, 2013, 178
- [18] Chou T.H., Chuang C.Y., Wu C.M., Quantification of Interleukin-6 in cell culture medium using surface plasmon resonance biosensors, *Cytokine*, 2010, 51
- [19] Huang J., Harvey J., Derrick Fam W. H., Nimmoc M.A., Alfred Tok I.Y., Novel biosensor for Interleukin-6 detection, *Procedia Engineering* 2013, 60
- [20] Strakosas X., Bongo M., Owens R. M., The organic electrochemical transistor for biological applications, *J. Appl. Polym. Sci.*, 2015

- 
- [21] Owens R. M. and Malliaras G.G., Organic Electronics at the Interface with Biology, MRS Bull., 2010, 35
- [22] Yang S. Y., De Franco J. A., Sylvester Y. U., Gobert T. J., Macaya D. J., Owens R. M., Malliaras G. G., Integration of a surface-directed microfluidic system with an organic electrochemical transistor array for multi-analyte biosensors, Lab Chip, 2009, 9
- [23] Makaraviciute A., Ramanaviciene A., Site-directed antibody immobilization techniques for immunosensors, Biosens. Bioelectro., 2013, 50
- [24] Yang L., Chen P., Chitosan/coarse filter paper composite membrane for fast purification of IgG from human serum, J. Membrane Sci., 2002, 205
- [25] Wena Z., Niemeyer B., Evaluation of two different Concanavalin A affinity adsorbents for the adsorption of glucose oxidase, J. Chrom. B, 2007, 857
- [26] Tarabella G., Santato C., Yang S. Y., Iannotta S., Malliaras G. G., Cicoira F., Effect of the gate electrode on the response of organic electrochemical transistors, App. Phys. Lett., 2010, 97
- [27] Militano, F., Poerio, T., Mazzei, R., Piacentini, E., Gugliuzza, A., Giorno, L., Influence of protein bulk properties on membrane surface coverage during immobilization, Colloid Surface B, 2016, 143
- [28] Bergstrom G., Mandenius C.F., Orientation and capturing of antibody affinity ligands: Applications to surface plasmon resonance biochips, Sens. Actuat. B, 2011, 158
- [29] Adamson, A.W., Physical Chemistry of Surfaces, fifth ed. John Wiley and Sons, New York, 1990
- [30] Tan Y. H., Liu M., Nolting B., Go J. G., Gervay-Hague J., Liu G., A Nanoengineering Approach for Investigation and Regulation of Protein Immobilization, ACS NANO, 2008, 2
- [31] Song H.Y., Zhou X., Hobley J., Su X., Comparative Study of Random and Oriented Antibody Immobilization as Measured by Dual Polarization Interferometry and Surface Plasmon Resonance Spectroscopy, Langmuir, 2011, 28

[32] Huang J., Chen H., Niu W., Fam D. W. H., Palaniappan A., Larisika M., Faulkner S. H., Nowak C., Nimmo M. A., Liedberg B., Tok A. I. Y., Highly manufacturable graphene oxide biosensor for sensitive Interleukin-6 detection, *RSC Adv.*, 2015, 5



### *Overall conclusions*

The research work discussed in this dissertation was directed towards extensive experimental studies for development of bio-hybrid regenerated cellulose-based membranes, including detailed analysis of chemical interaction between the biomolecules and the membrane surface, development of multifunctional bio-active membranes, design of selective membranes with bio-recognition and bio-separation properties and their application in bio-sensing area.

In the first part of the work, regenerated cellulose (RC) membranes have been functionalized by chemical treatment in two different ways and they have been used for the covalent immobilization of biomolecules. The effect of proteins bulk properties (concentration, charge, size and aggregation phenomena) on the kinetics of binding, surface coverage, structural rearrangement and the proteins bio-activity after immobilization were investigated. Bovine serum albumin, protein G, the enzyme lipase form *Candida rugosa* and the enzyme phosphotriesterase have been used as model biomolecules to study the immobilization process.

Membranes with aldehyde reactive groups have been prepared and the biomolecules were immobilized *i)* directly on the membrane surface and *ii)* after the introduction of a spacer. The effective proteins size and aggregation phenomena have been determined by simulating the operating conditions (temperature, pH, ionic strength, and buffer composition) of the immobilization procedure. The immobilization behavior was investigated as a function of the initial proteins concentration and membrane type and it was correlated to the proteins properties in solution. The results showed that the aggregation behavior of a protein significantly influences the formation of the bio-layer on the membrane surface, including surface coverage, layer structure (protein structural rearrangement) and protein activity. In particular, for BSA and protein G, that did not show aggregation phenomena in solution a protein monolayer was obtained. This reflected the monomers and the small oligomers formed in solution (as demonstrated by the morphological analysis). Conversely, in the case of lipase and phosphotriesterase enzymes that strongly aggregated in solution, the monolayer saturation coverage was not reached resulting on the formation of multilayer structures. Moreover, in the case of lipase the aggregation behavior has proven to have a positive effect on the proteins activity whereas the opposite result was obtained for phosphotriesterase. Regarding to the type of

functionalized membrane, it was found that the use of the spacer, which had a proper length, positively affected the proteins activity, and also the rate of immobilization.

The overall results obtained contributed on understanding the behavior of a protein at the membrane interface during chemical immobilization. This is an important factor for developing strategies to manipulate and control the protein surface coverage, distribution and orientation and related bio-activity. Bio-hybrid membranes with different functional properties and different potential applications in bioprocesses were developed.

The bio-functional membrane with immobilized protein G was employed to design bio-hybrid systems able to selectively recognize target molecules of diagnostic interest, in particular interleukin-6 (IL-6), on the basis of immuno-affinity interactions. The main challenges on the development of a bio-active surface for bio-sensing application are: *i)* to preserve the functionality of the bio-recognition element after immobilization, *ii)* to minimize non-specific interactions and *iii)* the possibility to regenerate and reuse the bio-functional surface. Herein, two strategies were used in order to meet all these requirements exploiting the protein G-coupled membrane for the site-specific and oriented immobilization of the antibody to IL-6. In the first strategy, after the antibody immobilization, the immuno-affinity membrane was directly used for the IL-6 capturing and recognition. In the second strategy, the anti IL-6 antibody was stabilized by chemical cross-linking with glutaraldehyde. The antibody binding capacity of the protein G-coupled membrane was studied. A maximum binding capacity of  $43.8 \mu\text{g}/\text{cm}^2$  was obtained corresponding to a high binding efficiency of 88%. The bio-recognition properties of both immuno-affinity membranes, in terms of IL-6 capture ability and efficiency, were compared. Furthermore, the stability and selectivity of the antibody as well as the possibility of regeneration and reuse of the bio-hybrid membranes were evaluated. The specificity of the system was improved by using and optimizing a quenching procedure that permitted to completely eliminate non-specific interactions. Both strategies have proven to be useful for the development of selective and efficient systems: it was obtained a capture efficiency of the IL-6 up to 91 %. This very high capture efficiency is a key factor to develop a detection technology in which the concentration of targeted molecules is very low. Moreover, both membranes revealed a linear relationship between the amount of the captured IL-6 and the initial IL-6 concentration, demonstrating a great potential to be used directly for immuno-assays and immunosensors. While, thanks to the cross-linking, only the second strategy permitted the antibody linkage stabilization and thus, the regeneration and efficient reuse of the immuno-affinity system. Indeed, the cross-link

method with glutaraldehyde did not affect the antigen binding capacity permitting the membrane reuse with similar performances of the first use (70% capture efficiency). Immuno-selective membranes that fulfill the key requirements for a bio-functional interface for bio-sensing application were developed and for the first time they have been efficiently used for IL-6 capture and recognition.

The membrane with the cross-linked antibody was used as IL-6 concentrator and it was integrated with a detection system based on organic electrochemical transistor to successfully increase the detection sensitivity of the system of around one order of magnitude.

---

## Appendix

### Publications

- **F. Militano**, T. Poerio, R. Mazzei, S. Salerno, L. De Bartolo, L. Giorno. *Development of immuno-selective membranes for target antigen recognition*. *Biosensors and Bioelectronics*, 92 (2017) 54-60
- **F. Militano**, T. Poerio, R. Mazzei, E. Piacentini, A. Gugliuzza, L. Giorno. *Influence of proteins bulk properties on membrane surface coverage during immobilization*. *Colloids and Surfaces B: Biointerfaces*, 143 (2016) 309-317
- L. Giorno, G. Vitola, G. Ranieri, **F. Militano**, *Biocatalytic Membrane Reactors with Chemically Bound Enzyme*. *Encyclopedia of Membranes*, Springer (2016), pp. 194-200
- **F. Militano**, L. Giorno. *Affinity membranes*. *Encyclopedia of Membranes*, Springer (2016), pp. 15-19
- L. Giorno, **F. Militano**. *Mass of immobilized Enzymes*. *Encyclopedia of Membranes*, Springer (2016), pp. 1131-1132
- **F. Militano**, T. Poerio, R. Mazzei, L. Giorno. *Nanostructured membranes for biosensors development*. In “Nanostructured Materials Membranes”, E. Drioli, L. Giorno, A. Gugliuzza (Eds.), Pan Stanford Publishing, (accepted)
- *Pico-Molar Cytokines detection with an Antibody-Antigen Electrochemical Label-Free Sensing by Organic Devices* (in preparation)

### Proceedings

#### *Oral presentations*

- **F. Militano**, T. Poerio, R. Mazzei, E. Piacentini, A. Gugliuzza, L. Giorno. “Development of biofunctional membranes for oriented antibody immobilization”. International Conference on Membrane Processes, PERMEA & MELPRO, P6/SL 45, May 2016, Prague (Czech Republic)
- **F. Militano**, T. Poerio, R. Mazzei, E. Piacentini, A. Gugliuzza, L. Giorno. “Study of biomolecules covalent immobilization for bioactive cellulose membrane fabrication”. Early-stage and Experienced Researchers Seminars “ITM Seminar days”, November 2015, University of Calabria (Italy)

- **F. Militano**, E. Piacentini, T. Poerio, R. Mazzei, L. Giorno. “Lipase from *Candida Rugosa* immobilization on cellulose functionalized membrane”. XXV National Congress of the Italian Chemical Society, *BIO-019*, September 2014, University of Calabria (Italy)

*Poster presentations*

- **F. Militano**, R. Mazzei, G. Vitola, M.V. Marciandò, T. Poerio, E. Porzio, G. Manco, L. Giorno. “Biocatalytic regenerated cellulose membrane to detoxify organophosphate pesticides and nerve agents”. Early-stage and Experienced Researchers Seminars “ITM Seminar days”, November 2015, University of Calabria (Italy)
- **F. Militano**, T. poerio, R. Mazzei, L. Giorno. “Development of immuno-affinity membrane for the capture and detection of molecules involved in inflammatory processes”. Early-stage and Experienced Researchers Seminars “ITM Seminar days”, December 2014, Rende (Italy)
- **F. Militano**, E. Piacentini, T. Poerio, R. Mazzei, L. Giorno. "Enzymes immobilization on polymeric functionalized membranes for bio-catalytic processes". XXXI EMS Summer School on Innovative Membrane Systems, October 2014, Cetraro (Italy)