

# UNIVERSITA' DELLA CALABRIA

---

**Facolta di Scienze Matematiche Fisiche e Naturali**

**Dipartimento di Chimica**

**Scuola di Dottorato Bernardino Telesio – Scuola di Scienza e Tecnica**

**Ph.D Course on:  
Organic Materials of Pharmacological Interest  
(OMPI, XXV cycle)**

SSD CHIM/06 Organic chemistry

Thesis

**Recovery of molecules of pharmacological interest  
from blood orange juice by  
integrated membrane operations**

Supervisors

Prof. Bartolo GABRIELE

Prof. Giuseppe SALERNO

Dr. Alfredo CASSANO

Coordinator

Prof. Bartolo GABRIELE

School Director

Prof. Roberto BARTOLINO

PhD Student

Fitim DESTANI

---

Anno Accademico 2011-2012

*Alla mia famiglia*

# INDEX

<b>Introduction</b>	1
<b>Chapter I – Membrane processes</b>	
1.1 Introduction	5
1.2 Synthetic membranes and methods of preparation	7
1.3 Membranes with Symmetric and Asymmetric Structure	14
1.4 General terminology and definitions	16
1.5 Fluxes and driving forces in membrane separation processes	19
1.6 Membrane and module configuration	20
1.7 Membrane operations	27
References	39
<b>Chapter II – General properties of citrus fruits</b>	
2.1 Introduction	42
2.2 World production	43
2.3 Anatomorphology of citrus fruit	49
2.4 Prevention potential of Citrus	50
2.5 Citrus biocompounds	54
References	61
<b>Chapter III – Clarification of blood orange juice</b>	
3.1 Introduction	64
3.2 Material and methods	66
3.3 Results and discussion	72
References	80
<b>Chapter IV – Osmotic distillation of clarified blood orange juice</b>	
4.1 Introduction	83
4.2 Materials and methods	84
4.3 Results and discussion	87
References	94
<b>Chapter V - Analysis of anti-inflammatory activity of blood orange juice treated by membrane operations</b>	
5.1 Introduction	96
5.2 Materials and methods	99
5.3 Results and discussion	101
References	107
<b>Conclusions</b>	109

# Introduction

Fruits and vegetables play an important role in human nutrition. They are vital sources of essential minerals, vitamins, and dietary fiber, and supply complex carbohydrates, and proteins. They are good sources of calcium, phosphorus, iron, and magnesium and contribute over 90% of dietary vitamin C. Green and yellow fruits and vegetables are a rich source of vitamin A (b-carotene). Thiamine, niacin, and folic acid, which are required for normal functioning of the human body, are also present in significant quantities.

Recent developments in agriculture have contributed significantly to improved production of fruits throughout the world. Storage practices have been developed for each kind of fruit. Improved packages have been developed that protect the fruit and add impact on the health of the consumer. Foods characterised by protective and health-promoting potential, in addition to their nutritive value, are recognised as functional foods. The beneficial components in functional foods have been called by various terms such as phytochemicals, functional components and bioactive compounds.

Citrus fruits rank first in the world with respect to production among fruits. They are grown commercially in more than 50 countries around the world. In addition to oranges, mandarins, limes, lemons, pummelos, and grapefruits, other citrus fruits such as kumquats, Calamondins, citrons, Natsudaidais, Hassakus, and many other hybrids are also commercially important. Citrus fruit production recorded a handsome increase during the 1990s, and recently reached more than 150 million tons. Considering the therapeutic value of these fruits and the general health awareness among the public, citrus fruit are gaining importance worldwide, and fresh fruit consumption is likely to increase. Postharvest biology and technology has evolved into a branch of science that combines biology and engineering. It has evolved rapidly over the past four or five decades, although scattered research efforts in various aspects of this field have been made previously all over the world. Increased citrus production combined with concern about growing population accelerated research and stimulated the development of new technologies in basic and applied areas.

Epidemiological studies have consistently demonstrated that there is a clear significant positive association between the intake of fruit and vegetables and the reduced rate of

heart disease mortality, common cancers and other degenerative diseases as well as ageing. The protection that fruit and vegetables provide against these diseases has been attributed to various bioactive compounds.

In particular, most of the antioxidant capacity of fruit and vegetables can be attributed to polyphenolic compounds (such as flavonols, flavanols, anthocyanins and phenylpropanoids), other than vitamin C, vitamin E and  $\beta$ -carotene, which act as antioxidants or as agents of other mechanisms contributing to anticarcinogenic or cardioprotective action.

Citrus fruits are rich in flavonoids compounds, which have anticancer properties. Citrus fruit flavonoids have been shown to inhibit the growth of cancer cells and prevent the spread of tumors. Citrus flavonoids are also antioxidants that can neutralize free radicals and may protect against heart disease. Further they may improve blood flow through coronary arteries, reduce the ability of arteries to form blood clots and prevent the oxidation of LDL (“bad”) cholesterol, which is an initial step in the formation of artery plaques.

In addition to being rich sources of flavonoids, citrus fruits are high in vitamin C, and are good sources of folate and potassium. Vitamin C is a powerful antioxidant and protects the body from damaging free radicals. It is also required for the synthesis of collagen, which helps wounds heal and helps hold blood vessels, tendons, ligaments and bone together.

Conserving the peculiarity of fresh fruit as well as colour, aroma, nutritional value and structural characteristics as much as possible, the food industry has focused on the development of processed items with increased shelf-life. On the other hand, during the industrial transformation, a large part of the characteristics determining the quality of the fresh product undergoes a remarkable modification: the thermal damage and the chemical oxidation degrade the most sensitive components reducing the quality of fresh fruits.

In order to solve these problems and to better preserve the properties of fresh fruits, several new “mild” technological processes have been proposed in the last years.

Within the agro-food industry, membrane technologies can work as well or better than the existing technology regarding product quality, energy consumption and environmental issues. The use of membrane separation, clarification, purification and

concentration processes represents one of the most powerful tools for the agro-food industry to introduce innovative processes in order to pursue targets such as process intensification and reduction of production costs. In addition, membrane operations represent a valid alternative to thermal evaporation processes which cause the deterioration of heat sensitive compounds leading to a remarkable qualitative decline of the final product. On the other hand, current filtration of a wide variety of juices is performed by using fining agents such as gelatine, diatomaceous earth, bentonite and silica sol which cause problems of environmental impact due to their disposal.

Juice clarification, stabilisation, depectinization and concentration are typical steps where membrane processes such as microfiltration (MF), ultrafiltration (UF), nanofiltration (NF) and osmotic distillation (OD) have been successfully used and are today very efficient systems to preserve the nutritional and organoleptic properties of the fresh product owing to the possibility of operating at room temperature with low energy consumption and without chemical additives.

The aim of this work was to study the effect of an integrated membrane process in the separation, recovery and concentration of bioactive compounds in the blood orange juice.

In the first Chapter, a general introduction on membrane science and technologies, including their advantages over traditional separation processes, is reported. A description of the chemical composition of Citrus fruits and their bioactive compounds which are of interest for nutraceutical applications, is reported in Chapter II. The clarification of the blood orange juice and the effect of an UF membrane on the recovery of phenolic compounds from the depectinised blood orange juice are analysed and discussed in Chapter III. The concentration of the clarified juice by OD and the performance of the OD process in terms of productivity and quality of the concentrated juice are analysed in Chapter IV. Finally, Chapter V discusses the results obtained in the evaluation of the anti-inflammatory activity of clarified and concentrated juices produced through an integrated membrane process UF/OD.

The recovered fractions from the blood orange juice through the investigated membrane processes represent an ideal substrate for the formulation of new products with improved characteristics for food, pharmaceutical and nutraceutical applications.

These studies offer also interesting perspectives for the recovery and reuse of bioactive compounds from other citrus fruits and from by-products of the industrial transformation of fruit and vegetables.

## CHAPTER I

# MEMBRANE PROCESSES

### 1.1 Introduction

The term membrane most commonly refers to a thin, film-like structure that separates two fluids. It acts as a selective barrier, allowing some particles or chemicals to pass through, but not others. In some cases, especially in anatomy, membrane may refer to a thin film that is primarily a separating structure rather than a selective barrier.

The concept of a membrane has been known since the eighteenth century, but it remained as only a tool for physical / chemical theories development until the end of World War II, when drinking water supplies in Europe were compromised and membrane filters were used to test for water safety. However, due to the lack of reliability, slow operation, reduced selectivity and elevated costs, membranes were not widely exploited. Microfiltration (MF) and ultra-filtration (UF) represent the membranes first used on the large scale. Since the 1980's, these separation processes, along with electrodialysis, are employed in large plants and, today, a number of experienced companies serve the market. A membrane is a layer of material which serves as a selective barrier between two phases and remains impermeable to specific particles, molecules, or substances when exposed to the action of a driving force. Some components are allowed passage by the membrane into a permeate stream, whereas others are retained by it and accumulate in the retentate stream [1].

Membrane engineering has already provided interesting solutions to some of the major problems of our modern industrialized society. Membrane processes meet the requirements of process intensification because they have the potential to replace conventional energy-intensive techniques, to accomplish the selective and efficient transport of specific components, and to improve the performance of reactive processes. Membrane techniques are essential to a wide range of applications including the production of potable water, energy generation, tissue repair, pharmaceutical



production, food packaging and the separations needed for the manufacture of chemicals, electronics and a range of other products [2].

Membrane processes are today consolidated systems in various productive sectors for their capacity to operate at room temperature and with low energetic consumption [3].

Membrane science and technology has led to significant innovation in both processes and products over the last few decades, offering interesting opportunities in the design, rationalization, and optimization of innovative productions [4]. At the heart of every membrane process there is an interface clearly materialized by a nano-structured/functionalized thin barrier. It controls the exchange between two phases not only by external forces and under the effect of fluid properties, but also through the intrinsic characteristics of the membrane material itself [5]. The separation, concentration and purification of molecular mixtures are major problems in the chemical industries. Membrane processing is a technique that permits separation, purification, clarification and concentration without the use of heat. Particles are separated on the basis of their molecular size and shape with the use of pressure and specially designed semi-permeable membranes.

Membrane technology has already gained a huge importance in the last two decades and now is competing with other separation technologies in terms of energy efficiency, high separation capacity, selective separation and capital investments. In many areas of applications, the conventional separation processes have been replaced with the ones based on membranes. In water desalination, for example, conventional thermal based processes have been replaced with RO due to their less energy intensive nature combined with small foot print and safer operations [6].

Membrane filtration can be a very efficient and economical way of separating components that are suspended or dissolved in a liquid. Among the various types of membranes, composite membranes commonly consist of a porous support layer with a thin dense layer on top that forms the actual membrane [7].

Efficient separation processes are needed to obtain high-grade products in the food and pharmaceutical industries to supply communities and industry with high quality water and to remove or recover toxic or valuable components from industrial effluents. For this task a multitude of separation techniques such as distillation, precipitation, crystallization, extraction, adsorption, and ion-exchange are used today. More recently,

these conventional separation methods have been supplemented with a family of processes based on the use of semi-permeable membranes as separation barriers.

Membranes and membrane processes were first introduced as an analytical tool in chemical and biomedical laboratories; they developed very rapidly into industrial products and methods with significant technical and commercial impact. The basic properties of membrane operations make them ideal for industrial production: they are generally athermal and do not involve phase changes or chemical additives; they are simple in concept and operation, modular and easy to scale-up; furthermore, they are characterized by a low energy consumption permitting a rational utilization of raw materials and recovery and reuse of by-products. The membranes used in various applications differ widely in their structure, in their function and in the way they are operated. However, all membranes have several features in common that make them particularly attractive tools for the separation of molecular mixtures [8].

## 1.2 Synthetic membranes and methods of preparation

Synthetic membranes are fabricated in two main geometries:

1. Flat sheet—utilized in the construction of flat sheet, disc, spirally wound, plate, and frame modules.
2. Cylindrical—utilized in tubular and capillary, or hollow fiber modules.

Membranes can be prepared from both ceramic and polymeric materials. Ceramic materials have several advantages over polymeric materials, such as higher chemical and thermal stability. However, the market share of polymeric membranes is far greater than ceramic membranes as the polymeric materials are easier to process and less expensive. A handful of technical polymers are currently used as membrane materials for 95% of all practical applications [9]. Polymeric materials that are used to prepare separation membranes are mostly organic compounds. A number of different techniques are available to prepare synthetic membranes. In Table 1.2-1, a schematic representation of different materials used for preparation of membranes has been given.

Table 1.2-1 Schematic representation of different membrane materials

Material	Application					
	MF	UF	NF/RO	GS	PV	MD
Cellulose acetate	X	X	X	X	X	
Cellulose esters	X					
Cellulose nitrate	X					
Poly (vinyl alcohol)	X					
Polyacrylonitrile		X			X	
Poly (vinyl chloride)	X					
PVC copolymer	X	X				
Aromatic polyamide	X	X	X			
Aliphatic polyamide	X	X				
Polyimide	X	X	X	X		
Polysulfone	X	X				
Polyetheretherketone (PEEK)	X	X		X		
Polycarbonate	X					
Polyester	X					
Polypropylene	X				X	X
Polyethylene	X				X	X
Polytetrafluoroethylene (PTFE)	X	X			X	
Poly (vinylidene difluoride) (PVDF)	X	X			X	X
Polydimethylsiloxane (PDMS)				X	X	

MF Microfiltration  
 UF Ultrafiltration  
 NF Nanofiltration  
 RO Reverse osmosis  
 GS Gas separation  
 PV Pervaporation  
 MD Membrane distillation

Although synthetic membranes show a large variety in their physical structure and chemical nature, they can conveniently be classified in five basic groups:

- (1) microporous media;
- (2) homogeneous solid films;
- (3) asymmetric structures;
- (4) electrically charged barriers;
- (5) liquid films with selective carriers.

This classification, however, is rather arbitrary and there are many structures which would fit more than one of the abovementioned classes, e.g., a membrane maybe

microporous, asymmetric in structure, and carry electrical charges. Any other classification of synthetic membranes, e.g., according to their application or methods of preparation, would serve the same purpose of phenomenologically categorizing the various types of synthetic membranes [10].

- *Neutral microporous membranes*

Neutral, microporous films represent a very simple form of a membrane which closely resembles the conventional fiber filter as far as the mode of separation and the mass transport are concerned. These membranes consist of a solid matrix with defined holes or pores which have diameters ranging from less than 2 nm to more than 20  $\mu\text{m}$ . Separation of the various chemical components is achieved strictly by a sieving mechanism with the pore diameters and the particle sizes being the determining parameters. Microporous membranes can be made from various materials, such as ceramics, graphite, metal or metal oxides, and various polymers. Their structure may be symmetric, i.e., the pore diameters do not vary over the membrane cross section, or they can be asymmetrically structured, i.e., the pore diameters increase from one side of the membrane to the other by a factor of 10 to 1,000. The properties and areas of application of various microporous filters are summarized in Table 1.2-2.

Table 1.2-2 Microporous membranes: preparation and application

Membrane type	Membrane material	Pore size	Manufacturing process	Application
<b>Microporous membrane</b>	Ceramic, metal or polymer powder	0.1–20 $\mu\text{m}$	pressing and sintering of powder	Microfiltration
	Homogeneous polymer sheets (PE, PTFE)	0.5–10 $\mu\text{m}$	stretching of extruded polymer sheet.	Microfiltration, burn dressings, artificial blood vessels.
	Homogeneous polymer sheets (PC)	0.02–10 $\mu\text{m}$	track-etching	Microfiltration
	Polymer solution (CN, CA)	0.01– 5 $\mu\text{m}$ 2nm – 5 $\mu\text{m}$	phase inversion	Microfiltration, Ultrafiltration, Sterilization.

- *Symmetric microporous sintered membranes*

Sintered membranes are the simplest in their function and in the way they are prepared. The structure of a typical sintered membrane is shown in the scanning electron micrograph of Figure 1.2-1. This photograph shows a PTFE microporous membrane made by pressing a fine powder into a film or plate of 100 to 500  $\mu\text{m}$  thickness and then sintering the film at a temperature which is just below the melting point of the polymer. This process yields a microporous structure of relatively low porosity, in the range of 10 to 40% and a rather irregular pore structure with a very wide pore size distribution.

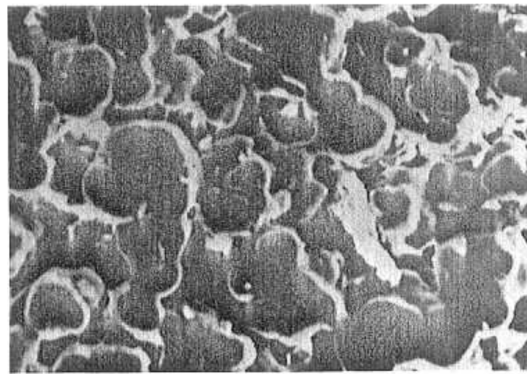

Figure 1.2-1 SEM of a microporous sintered membrane prepared from a PTFE powder.

Sintered membranes are made on a fairly large scale from ceramic materials, glass, graphite and metal powders such as stainless steel and tungsten. The particle size of the powder is the main parameter determining the pore sizes of the final membrane, which can be made in the form of discs, candles, or fine-bore tubes. Sintered membranes are used for the filtration of colloidal solutions and suspensions. This type of membrane is also marginally suitable for gas separation. It is widely used today for the separation of radioactive isotopes, especially uranium.

- *Stretched membranes*

A relatively simple procedure for preparing microporous membranes is the stretching of a homogeneous polymer film of partial crystallinity. This technique is mainly employed with films of polyethylene or PTFE which have been extruded from a polymer powder and then stretched perpendicular to the direction of extrusion [11, 12]. This leads to a partial fracture of the film and relatively uniform pores with diameters of 1 to 20  $\mu\text{m}$ . A

typical stretched membrane prepared from PTFE is shown in the scanning electron micrograph of Figure 1.2-2.

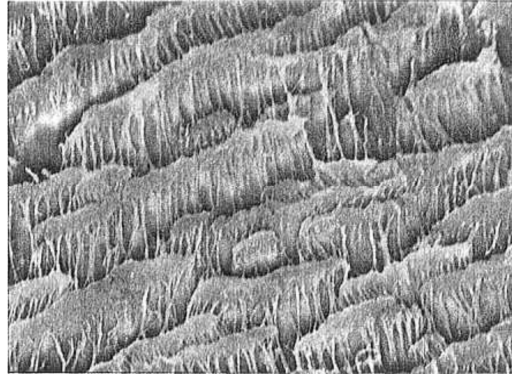

*Figure 1.2-2 SEM of a microporous membrane prepared by stretching an extruded PTFE film perpendicular to the direction of extrusion.*

These membranes, which have a very high porosity, up to 90%, and a fairly regular pore size are now widely used for microfiltration of acid and caustic solutions, organic solvents, and hot gases. They have to a large extent replaced the sintered materials used earlier in this application.

Stretched membranes can be produced as flat sheets as well as tubes and capillaries. The stretched membrane made out of PTFE is frequently used as a water repellent textile for clothing, such as parkas, tents, sleeping bags, etc. This membrane type has, because of its very high porosity, a high permeability for gases and vapors, but, because of the hydrophobic nature of the basic polymer, is up to a certain hydrostatic pressure completely impermeable to aqueous solutions. Thus, the membrane is repellent to rain water but permits the water vapor from the body to permeate. More recently, this membrane has also been used for a novel process, generally referred to as membrane distillation, i.e., to remove ethanol from fermentation broths or wine and beer to produce low alcohol products and for desalination of seawater. These membranes are also used for desalination of saline solutions and in medical applications such as burn dressings and artificial blood vessels [10].

- *Capillary pore membranes*

These membranes are made in a two step process. During the first step, a homogeneous 10 to 15  $\mu\text{m}$  thick polymer film is exposed to collimated, charged particles in a nuclear

reactor. As particles pass through the film, they leave sensitized tracks where the chemical bonds in the polymer backbone are broken. In the second step, the irradiated film is placed in an etching bath. In this bath, the damaged material along the tracks is preferentially etched forming uniform cylindrical pores. The pore density of a track-etched membrane is determined by the residence time in the irradiator, while the pore diameter is controlled by the residence time in the etching bath. The minimum pore diameter of these membranes is approximately  $0.01\ \mu\text{m}$ . The maximum pore size that can be achieved in track etched membranes is determined by the etching procedure. The polymer will not only be dissolved along the sensitized track left by the penetrating particle but also on both surfaces of the film. Thus, with exposure time in the etching medium the pore sizes increase and the thickness of the film is correspondingly reduced. The scanning electron micrograph in Figure 1.2-3 shows a typical track etched polycarbonate membrane.

Capillary pore membranes are prepared today mainly from polycarbonate and polyester films. The advantage of these polymers is that they are commercially available in very uniform films of 10 to 15  $\mu\text{m}$  thickness which is the maximum penetration depth of collimated particles obtained from a nuclear reactor which have an energy about 0.8 to 1 MeV. Particles with higher energy, up to 10 MeV, may be obtained in an accelerator. They are used today to irradiate thicker polymer films, up to 50  $\mu\text{m}$  thickness, or inorganic materials such as mica [13].

On an industrial scale, capillary pore membranes are used for the production of ultrapure water for the electronic industry. Here, they show certain advantages over other membrane products because of their short "rinse down" time and good long-term flux stability.

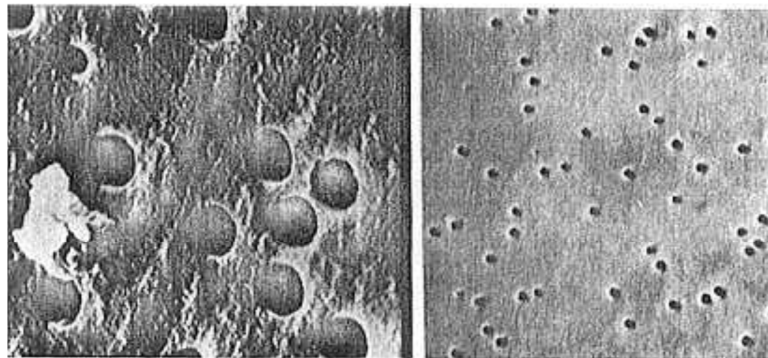

Figure 1.2-3 SEM of the surface of a capillary pore polycarbonate membrane.

Because of their surface filter characteristics, particles retained by the membranes can be further monitored by optical or scanning electron microscopy. Figure 1.2-4 shows a scanning electron micrograph of asbestos fibers accumulated on a capillary pore membrane in an air pollution control application.

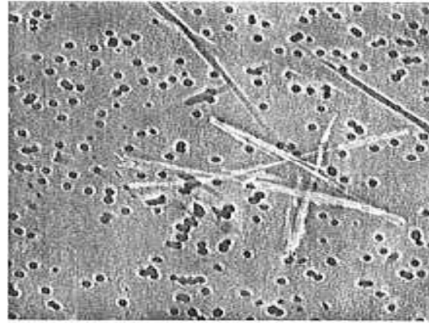

Figure 1.2-4 SEM of asbestos filter accumulated on the surface of a capillary pore membrane.

Depending on the application, different membrane morphologies will be used. In Figure 1.2-5 a schematic representation of different morphologies is given.

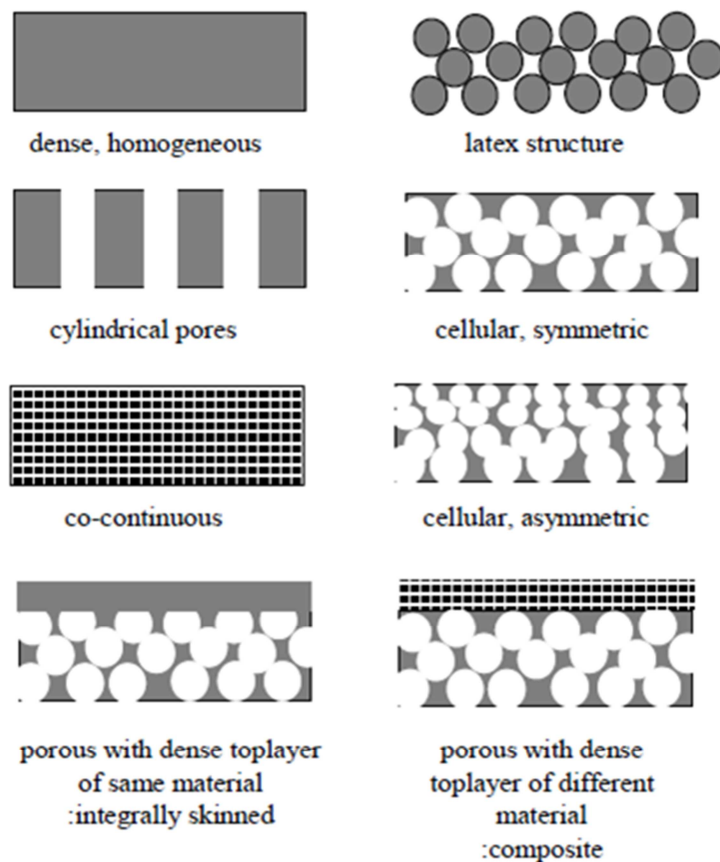

Figure 1.2-5 Schematic representation of different membrane morphologies.



The formation techniques of membranes and filters are shown in the Table 1.2-3.

Table 1.2-3 Formation techniques of membranes and filters

Fibers	Particles	Films
<ul style="list-style-type: none"> <li>wet-lay (many paper filters)</li> <li>dry-lay (spunbonded olefins)</li> <li>wound (glass filament cartridges)</li> <li>woven (polymeric and/or metal filter meshes)</li> </ul>	<ul style="list-style-type: none"> <li>sol-gel (ceramic ultrafilters)</li> <li>compression or sintering (metal and glass filters and frits)</li> <li>extruded (alumina microfilter monoliths)</li> </ul>	<ul style="list-style-type: none"> <li>extruded dense films (silicone films)</li> <li>extruded and stretched dense film (teflon and olefin microfilters)</li> <li>cast or extruded films with phase inversion step (cellulose acetate ultrafilters)</li> <li>nuclear-particle track etched (polycarbonate microfilters)</li> <li>electrochemical deposition (homoporous alumina microfilters)</li> </ul>

### 1.3 Membranes with Symmetric and Asymmetric Structure

#### 1.3.1 Symmetric structure

Although most of the practically useful membranes are asymmetric, as explained later, some of the membranes have symmetric structures. They are prepared in the following ways:

- Track etching - A sheet of polymeric film moves underneath a radiation source and is irradiated by high-energy particles. The spots that are subjected to bombardment of the particles are degraded or chemically altered during this process. Then, the film undergoes an etching process in an alkaline or hydrogen peroxide bath (depending on the material), where the polymer is etched along the path of high-energy particles.
- Precipitation from the vapor phase - A cast polymer solution that consists of polymer and solvent is brought into a nonsolvent vapor environment saturated with solvent vapor. The saturated solvent vapor suppresses the evaporation of solvent from the film; the nonsolvent molecules diffuse into the film causing polymer coagulation.

A schematic representation of the a symmetric structure is depicted in Figure 1.3-1.

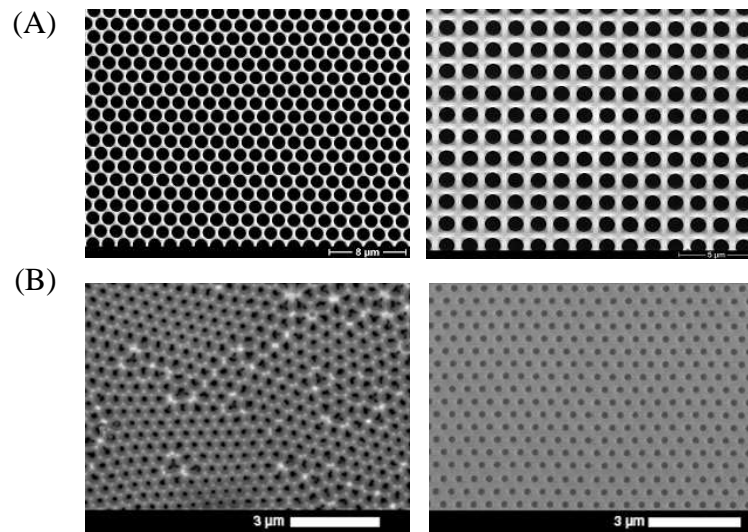

Figure 1.3-1 Schematic representation of symmetric structure.(a)Silicon Membranes;  
(b)Aluminum membranes morphologies

### 1.3.2 Aymmetric structure

Most membranes used in industries have an asymmetric structure. Figure 1.3-2 shows schematically a typical cross-sectional view of an asymmetric membrane. It consists of two layers: the top one is a very thin dense layer (also called the top skin layer), and the bottom one is a porous sub layer. The top dense layer governs the performance (permeation properties) of the membrane; the porous sub layer only provides mechanical strength to the membrane. The membranes of symmetric structures do not possess a top dense layer. In the asymmetric membrane, when the material of the top layer and porous sub layer are the same, the membrane is called "integrally skinned asymmetric membrane". On the other hand, if the polymer of the top skin layer is different from the polymer of the porous sub layer, the membrane is called "composite membrane". The advantage of the composite membrane over the integrally skinned asymmetric membrane is that the material for the top skin layer and the porous sub layer can be chosen separately to optimize the overall performance [9].

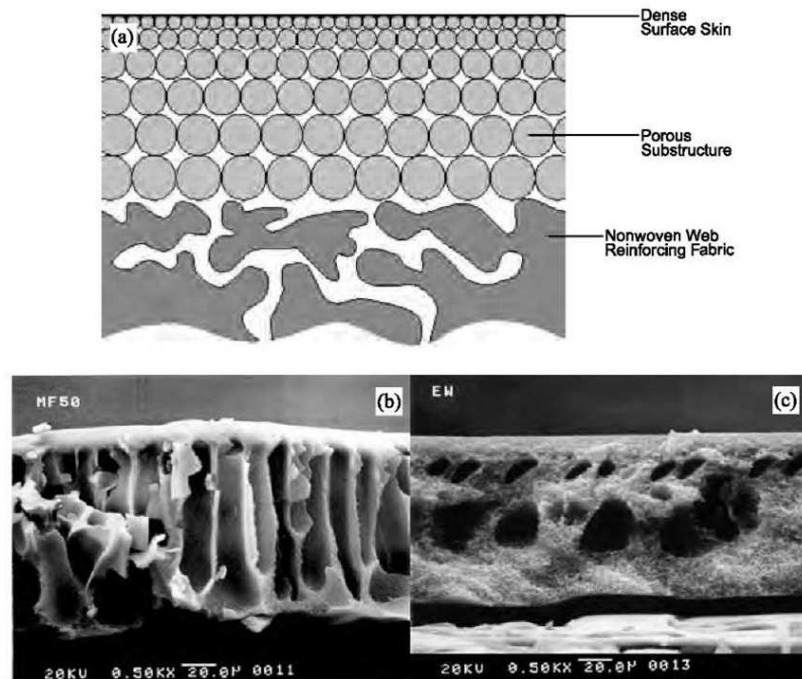

Figure 1.3-2 Schematic representation of asymmetric structure. Cross-section illustration of (a) an integrally skinned asymmetric membrane, plus SEM cross sections of dense-skinned (b) polyacrylonitrile and (c) polysulfone membranes manufactured by GE-Osmonics Inc.

#### 1.4 General terminology and definitions

Membrane filtration technology has developed a specialized terminology.

The definitions themselves provide a basis for discussing the equipment and operating principles.

- *Batch filtration:* A fixed volume of feed material is filtered and the retentate (the feed material not filtered) is recycled (or not removed) until a specific recovery of permeate is obtained. Thus the composition of the feed is continuously changing with time.
- *Cake:* The cake is whatever is left sitting on the membrane or filter's surface (or whatever builds up continuously during the filtration).
- *Concentration Polarization:* Accumulation of rejected solute on the feed side of the membrane or filter surface, excluding cake or adsorbed by layers.

Interrupting or stopping the filtration process allows the concentration polarization to dissipate.

- *Conductance*: The reciprocal of resistance. The flux of solvent(or solutes) through a membrane is often empirically described as being proportional to the product of a driving force and a conductance. Several layers with different thicknesses and specific conductances (conductance normalized by its thickness) may be combined to completely describe the membrane system under a variety of conditions.
- *Crossflow (tangential flow) filtration*: The main flow direction is across(tangential to) the membrane or filter surface. This operating mode will typically have a retentate.
- *Dead-end filtration*: The main flow direction is perpendicular to the membrane or filter's surface. This operating mode may or may not have a retentate.
- *Feed (or sample)*: The initial solution presented to the membrane or filter is called the feed. It can be a mixture of solvent, solutes, and particulates.
- *Fluid velocity (crossflow velocity)*: The average velocity in the feed channel in a flowing system or the average radial velocity across the membrane or filter's surface in a stirred system.
- *Flux*: The mass or volumetric flow through the filter/membrane per unit time per unit area.
- *Fouling*: Irreversible decline in flux due to adsorption, deposition, or other accumulation on the surface and/or in the pores of the membrane or filter. This can be caused by any combination of solutes, particulates, and precipitates.
- *Hydraulic pressure drop*: In a flowing system this is mechanical pressure required to move the feed through the device to become the retentate. It is mechanical energy required in addition to the average trans-membrane pressure (TMP). The viscosity of the feed solution and shape of the feed channel (including any inserts to increase mixing) will affect this energy requirement.
- *MWCO (molecular weight cut-off)*: The molecular mass of dissolved molecules for which a rejection of at least 90% will be observed based on the measurement technique and assumptions used by the manufacturer. A standard measurement technique does not exist.

- *Particulates*: These are species that are suspended in the primary solvent or continuous phase. Particulates can include colloids, cells (and cell fragments), viruses, spores, inorganic precipitates, dust, etc.
- *Permeability*: The permeance normalized for the thickness of the membrane or filter's separating layer.
- *Permeate (filtrate, product)*: Permeate refers to whatever passes through the membrane.
- *Pore size*: The diameter of the largest pore based on the measurement technique and assumptions used by the manufacturer. A standard measurement technique does not exist.
- *Permeance (pressure-normalized flux)*: The flux divided by the TMP.
- *Permselective*: A membrane is permselective towards a feed mixture if the concentrations in the permeate differ from the feed.
- *Recovery*: Percentage of the feed that permeates a single filtration stage. A stage may be an element, device, or module in which there is no interruption in the contact of the feed solution and the membrane or filter.
- *Rejection*: A measure of the fraction of solute or particulate retained by the membrane or filter. Several rejection quantities (e.g., true, observed, and average rejection, and sieving coefficient) are defined and used.
- *Retentate (concentrate, reject)*: Retentate is the fluid feed material that does not pass through the membrane or filter.
- *Solutes*: These are species that are dissolved in the primary solvent or continuous phase. Solutes can include salts and both small and large molecules of a variety of types.
- *Transmembrane pressure (TMP)*: The difference in absolute pressure across the thickness of the membrane or filter is called the transmembrane pressure. Depending upon the type of filtration operation this can change with position along the surface of the filter. Also it can result from a variety of sources, such as inert gas blanket, pumping, and centrifugal force [14].

### 1.5 Fluxes and driving forces in membrane separation processes

Separations in membrane processes are the result of differences in the transport rates of chemical species through the membrane interphase. The transport rate is determined by the driving force or forces acting on the individual components and their mobility and concentration within the interphase. The mobility is primarily determined by the solute's molecular size and the physical structure of the interphase material, while the concentration of the solute in the interphase is determined by chemical compatibility of the solute and the interphase material, the solute's size, and the membrane structure. The mobility and concentration of the solute within the interphase determine how large a flux is produced by a given driving force. In membrane separation processes there are three basic forms of mass transport. The simplest form is the so-called *passive transport*. Here, the membrane acts as a physical barrier through which all components are transported under the driving force of a gradient in their electrochemical potential. Gradients in the electrochemical potential of a component in the membrane interphase may be caused by differences in the hydrostatic pressure, the concentration, the temperature, or the electrical potential between the two phases separated by the membrane. The second form of mass transport through the membrane interphase is the so-called *facilitated transport*. Here, the driving force for the transport of the various components is again the gradient in their electrochemical potential across the membrane. The different components, however, are coupled to a specific carrier in the membrane phase. Facilitated transport, therefore, is a special form of the passive transport. Completely different, however, is the third form of mass transport through membranes. It is generally referred to as *active transport*. Here, various components may be transported against the gradient of their electrochemical potential. The driving force for the transport is provided by a chemical reaction within the membrane phase. Active transport is coupled with a carrier in the membrane interphase and is found mainly in the membranes of living cells [15]. It has, to date, no significance in synthetic membranes. The transport of mass in a membrane is a non equilibrium process and is conventionally described by phenomenological equations such as Fick's law which relates the fluxes of matter to the corresponding driving forces [16]:

$$J_i = -D_i \frac{dC_i}{dz}$$

$J$  = flux for species  $i$

$D_i$  = Diffusion coefficient for species  $i$

$\frac{dC_i}{dz}$  = Concentration gradient

Membrane systems, available in variety of separation capabilities have been introduced for their peculiarities in different fields. The removal of turbidity, precursors and disinfectant tolerant micro-organisms relating to both groundwater and surface water supplies, as well as tapping into new water supplies, such as brackish and seawater are some interesting applications [17]. The following table shows the membrane separation processes relative to contaminant size.

### 1.6 Membrane and module configuration

The practical equipment where the actual membrane based separation occurs is known as membrane module. The basic aim of development of membrane modules is to provide maximum membrane area in relatively smaller volume, so that the permeate flux i.e., the productivity of the system is maximum. These membrane modules are of five types: (i) plate and frame module, (ii) spiral wound, (iii) hollow fiber, (iv) capillary and (v) tubular.

#### 1.6.1 Membrane configuration

There are three different configurations in terms of the shape of membrane as shown below as shown in *Figure 1.6.1-1* [18].

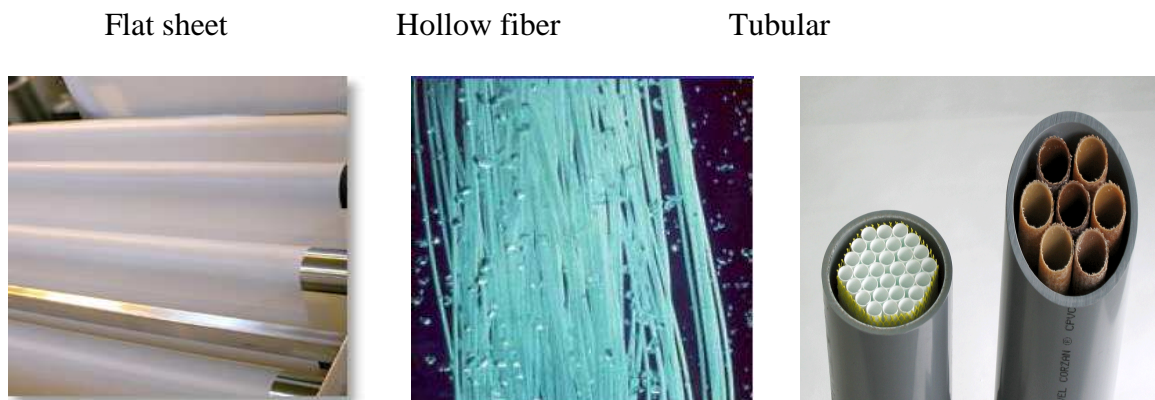

*Figure 1.6.1-1 Schematic representation of three different membrane configurations*

Different materials can be realized for pressure driven process like microfiltration (i.e., PVDF-MFB, MBR-200), ultrafiltration ( Polyacrylonitrile: PAN-50, PAN-200, PAN-350, PAN-400, PAN-400C/D, PAN-450; Polysulfone: PS-10, PS-20, PS-30, PS-35; Polyethersulfone: PES-2, PES-5, PES-10, PES-20, PES-900C/D; Poly(vinylidene fluoride): PVDF-4, PVDF-350, PVDF-400, PVDF-400B, PVDF-400R, PVDF-400HE, PVDF-400HB, PVDF-400HA), nanofiltration (NF-2A, NF-3A, NF-6) and reverse osmosis.

Packed in extreme high density, hollow fibres can range from smaller than a strand of human hair to bristles several hundred microns in diameter. Hollow fibre devices are used in both UF and RO applications. Fibres are produced by extrusion through annular dies. Thousands of strands are tightly bundled and bonded at the end into potting. The bundles are usually housed in PVC or stainless steel. When applied in a suitable application, hollow fibre membranes are more economical and cost effective than conventional separation methods.

When used properly, hollow fibre devices can function for years without replacement. These devices can be operated at high pressure, allowing them to desalt highly concentrated seawater. In special applications, they can be operated as high as 138 bar. Hollow fibre is a flexible membrane; it can carry out the filtration by either "inside-out" or "outside-in". Hollow fiber membranes have been successfully employed in industrial water, industrial wastewater, and beverage processing applications worldwide, and are particularly well suited to the high production demands of municipal drinking water and wastewater treatment plants. Regardless of flow pattern, hollow fiber membranes offer a compact, cost-effective solution for filtering large volumes of liquids utilizing minimal space and energy. Cross flow hollow fibre membrane also reduces fouling as the fluid flows from the inside of the hollow fibre and pass through to the outside of the membrane. Despite the size of the hollow fibre membrane being smaller than other types of membrane, its circular structure allows a higher surface area which in turn, yields a higher performance.

Tubular membranes can easily process solutions containing high suspended solids, and concentrate products proficiently and repeatedly to high end-point concentration levels without plugging, making them ideal for recovering wastewaters, and clarifying juices. Tubes can be used individually or grouped together in a package. Membranes are placed



inside a support porous tube, and these tubes are placed together in a cylindrical shell to form the unit module. Tubular devices are primarily used in MF and UF applications because of their ability to handle process streams with high solids and high viscosity properties, as well as for their relative ease of cleaning. Membrane area per unit volume is small and fouling is mainly eliminated by mechanical cleaning [19].

Tubular membranes have high durability due to their rugged construction and are extremely foulant-resistant. In cross-flow mode, the rugged large-diameter tubes allow for high velocity in the tubes even with very dirty process fluids. This maintains maximum “sweeping” action at the membrane surface and minimizes foulant build-up and clogging, even with high suspended solids [18].

### *1.6.2 Module configuration*

The Plate and frame (PF) configuration has been developed for relatively small scale applications that deal with high membrane fouling potential. The module structure is complex to seal the spaces among the membrane plates and pressure loss across the module is high due to the zigzag flow. Today, PF is primarily used for electro dialysis, leachate filtration, etc.

The heart of plate-frame module is the support plate that is sandwiched between two flat sheet membranes. The membranes are sealed to the plate, either gaskets with locking devices, glue or directly bonded. The plate is internally porous and provides a flow channel for the permeate which is collected from a tube on the side of the plate.

Ribs or grooves on the face of the plate provide a feed side flow channel. The feed channel can be a clear path with channel heights from 0.3 to 0.75 mm. The higher channel heights are necessary for high viscosity feeds; reduction in power consumption of 20 to 40% can be achieved by using a 0.6 mm channel compared to a 0.3 mm channel. Alternatively, retentate separator screens (20 or 50 mesh polypropylene) can be used. Commercial plate-frame units are usually horizontal with the membrane plates mounted vertically. They can be run with each plate in parallel plates in two or three series. Laboratory units are also available as preformed stacks up to 10 plates. A typical plate and frame module is shown in Figure 1.6.2-1.

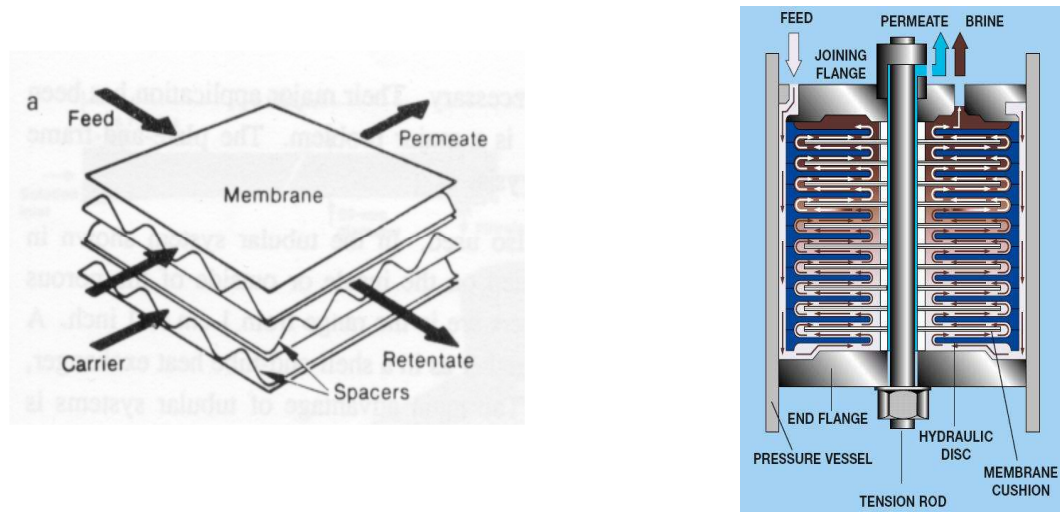

Figure 1.6.2-1 Schematic representation of: (a) plate and frame module; (b) flow diagram.

The *Spiral Wound (SW)* configuration was developed in 1970's to make plate and frame modules more compact for the feed with low fouling potential. It provides large specific surface area at relatively low costs. Feed water flows through feed channel parallel to the axis. The permeate travels permeate channel to be collected in the center pipe as shown in the figure *Figure 1.6.2-2*. This module configuration is most commonly used with the membranes with tight pore sizes such as UF, NF, and RO.

In spiral wound membrane, membrane is cast as a film onto flat sheet. Membranes are sandwiched together with feed spacers (typical thickness 0.03 to 0.1 inch) and permeate carrier. They are sealed at each edge and wound up around a perforated tube. The module diameter ranges from 2.5 to 18 inch and length varies from 30 to 60 inch.

The application of spiral wound module includes seawater desalination, brackish water treatment, potable water treatment, dairy processing, electro coat paint recovery, protein separation, whey protein concentration, etc. The modeling of plate and frame and spiral wound module can be done by considering the flow through a rectangular channel. On the other hand, for a tubular and hollow fiber module flow through circular device can be considered.

In hollow fiber (HF) configuration, lots of hollow fibers (each fiber is a tubular module) are kept in a large pipe. Geometry allows a high membrane surface area to be contained in a compact module. This means large volumes can be filtered, while utilizing minimal space, with low power consumption. The advantages of such modules include reduction

in space requirement, lowering in labor and chemical cost, lowering in chemical cost, delivery of high quality product water, etc.

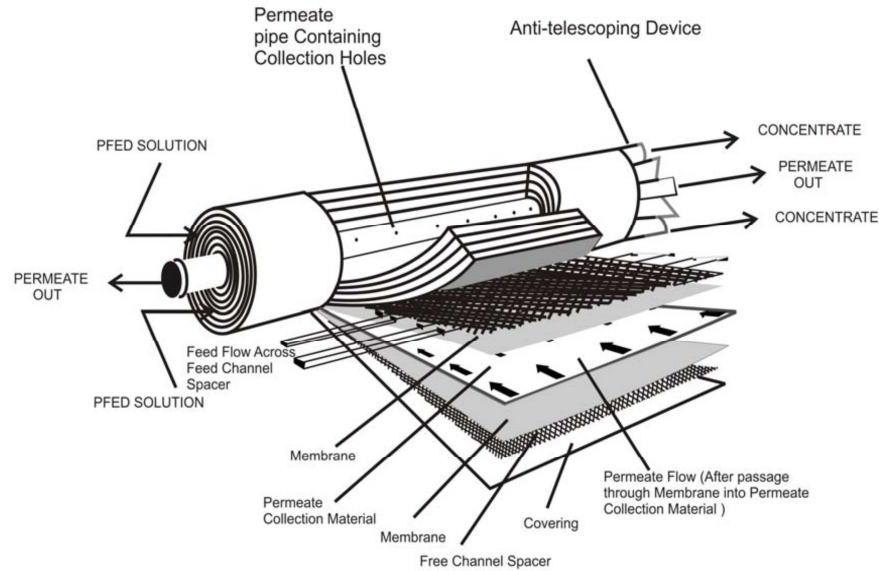

Figure 1.6.2-2 Schematic representation of spiral wound membrane module.

Most hollow fiber products are available in (i) 1" diameter laboratory test cartridges ranging up to 10" diameter for commercial products, (ii) standard commercial cartridge lengths of 25", 43", 48", 60" and 72", (iii) nominal separation ranges from 0.2 micron down to 1,000 MWCO, (iv) Fiber inside diameters from 0.02"(0.5mm) up to 0.106"(2.7mm), (v) Various materials of construction including polysulfone and polyacrylonitrile. Figure 1.6.2-4 shows some hollow fiber cartridges of 5, 8 and 10" diameter with endcaps.



Figure 1.6.2-3 Schematic representation of the hollow fiber module

The flow pattern in a typical hollow fiber module takes place as shown in *Figure 1.6.2-4*.

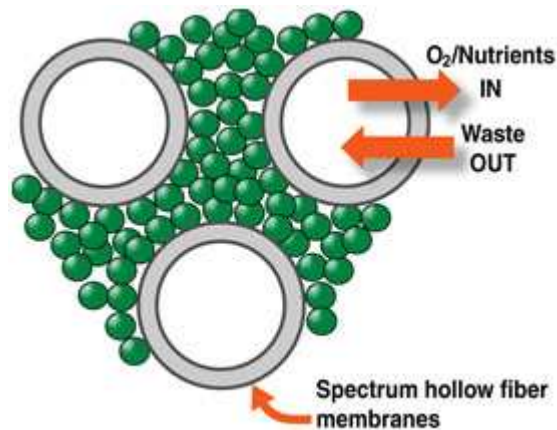

*Figure 1.6.2-4 Schematic representation of the hollow fiber module cross-section.*

The *capillary membrane* modules consist of a large number of capillary membranes with an inner diameter of 0.2 to 3 mm arranged in a parallel bundle in a shell tube. The feed solution is forwarded into the lumen of capillary membranes and the filtrate, which permeates the capillary wall, is collected in the shell tube. A schematic representation of the module is shown in the *Figure 1.6.2-5*.



*Figure 1.6.2-5 Schematic representation of the capillary membrane module.*

Tubular membrane modules are traditionally used for pressure filtration with feed water recirculation through lumen. In such modules, the membrane is cast on the inside surface of a porous tube. Tubular membranes operate in tangential, or cross-flow,

design where process fluid is pumped along the membrane surface in a sweeping type action. The feed solution is pumped through the center of the tube at velocities as high as 6 m/s. These cross-flow velocities minimize the formation of a concentration polarization layer on the membrane surface, promoting high and stable flux and easy cleaning, especially when the objective is to achieve high suspended solids in the MF, UF or NF concentrate. Some tubular membrane modules are shown in Figure 1.6.2-6.



*Figure 1.6.2-6 Schematic representation of the tubular membrane module.*

There are many advantages using tubular membrane configurations. Besides their rugged construction, they have a distinct advantage of being able to process high suspended solids, and concentrate product successfully and repeatedly to relatively high end point concentration levels without plugging. For juice clarification applications, tubular membrane systems produce the greatest yields and the highest final suspended solids concentration levels. Tubular MF, UF and NF systems do not require significant prefiltration [19].

Properties of membrane modules configurations are shown in Table 1.6.2-1. [18].

Table 1.6.2-1. Summary of membrane module configurations.

Membrane configuration	Module configuration or operating method	Driving force	Pore size	Common Applications	Example
Flat Sheet (FS)	Plate and frame (PF)	Pressure	MF/UF	WWT, EDI	Pall DT™, Electrocell (EC)
	Spiral wound (SW)	Pressure	UF/RO	DS, PR	Dow Filmtec, Hydranautics, Toray Romembra, Woongjin CSM®
Hollow Fiber (HF)	Contained in pressure vessels	Pressure	MF/UF/RO	WT, PR, <i>etc.</i>	Asahi Microza®, Toyobo Hollowsep®, GE ZW1500
	Immersed module without pressure vessels	Vacuum	MF/UF	WT, iMBR	GE ZW500, Asahi Microza®, Mitsubishi Sterapore™, Econity
Tubular (TB)	Pressure filtration	Pressure	MF/UF	WWT, PR, sMBR	Koch Abcor®, ITT PCI,
	Vacuum filtration with bubbling	Vacuum	MF/UF	sMBR	Norit Airlift™

DS: Desalination, ED: Electrodialysis, PR: Process Recovery, WT: Water Treatment, WWT: Wastewater Treatment

### 1.7 Membrane operations

The principal objective of a membrane separation process is the separation of a desirable substance from a given mixture. Today, almost all the membrane processes use synthetic membranes. Although biological membranes carry out a number of complicated separations in all life processes, they are not widely used. There are a number of membrane processes which can be defined by considering the following aspects:

- the nature of the species retained by the membrane,
- the nature of the species permeating through the membranes,
- the driving force needed to achieve the desired separation,
- the mechanism of separation.

There are several membrane separation processes which are of industrial importance today. They are briefly discussed below with respect to their principal characteristics [20].

### 1.7.1 Microfiltration

Microfiltration (MF) is the process of removing particles or biological entities in the 0.025 $\mu\text{m}$  to 10.0 $\mu\text{m}$  range from fluids by passage through a microporous medium such as a membrane filter. Although micron-sized particles can be removed by use of non-membrane or depth materials such as those found in fibrous media, only a membrane filter having a precisely defined pore size can ensure quantitative retention. This process also requires hydrostatic pressure gradient across the membrane and the pressure used is of the order of 100 kPa or so. The pore size of the membranes decides the size of the particulate matter retained. The process is similar to ultrafiltration and separation takes place by sieving. Membrane filters can be used for final filtration or prefiltration, whereas a depth filter is generally used in clarifying applications where quantitative retention is not required or as a prefilter to prolong the life of a downstream membrane. Membrane and depth filters offer certain advantages and limitations. They can complement each other when used together in a MF process system or fabricated device. The retention boundary defined by a membrane filter can also be used as an analytical tool to validate the integrity and efficiency of a system. For example, in addition to clarifying or sterilizing filtration, fluids containing bacteria can be filtered to trap the microorganisms on the membrane surface for subsequent culture and analysis. MF can also be used in sample preparation to remove intact cells and some cell debris from the lysate. Membrane pore sizes used for these types of separation are typically in the range of 0.05  $\mu\text{m}$  to 1.0  $\mu\text{m}$ .

The most used polymers for MF membranes are the hydrophobic polyvinylidene fluoride (PVDF), polypropylene (PP), polyethylene (PE), and the hydrophilic materials cellulose esters, polycarbonate (PC), polysulfone/polyethersulfone (PSf/PES), polyimide/polyetherimide and polyetheretherketone (PEEK). The ceramic membranes, which can be used both in micro- and ultrafiltration processes, have superior chemical, thermal, and mechanical stability compared to polymeric membranes, and the pore size can be more easily controlled.

MF membranes are prepared by sintering, track-etching, stretching, or phase inversion techniques. Module configurations include hollow fiber, tubular, plate and frame, spiral wound.

Different solutions can be processed by MF including milk, beer, wine, whiskies, potable water, syrups, edible oils and vinegar. On a molecular weight basis, these membranes can separate or reject macromolecules and generally solute less than 100,000 MW pass through these membranes. The separation mechanism of MF is commonly attributed to a molecular sieving; i.e. passage through the membrane is a function of particle size relative to opening or pore dimensions of the membrane. The operational mechanism of the functional layer of MF is illustrated in figure 1.7.1-1.

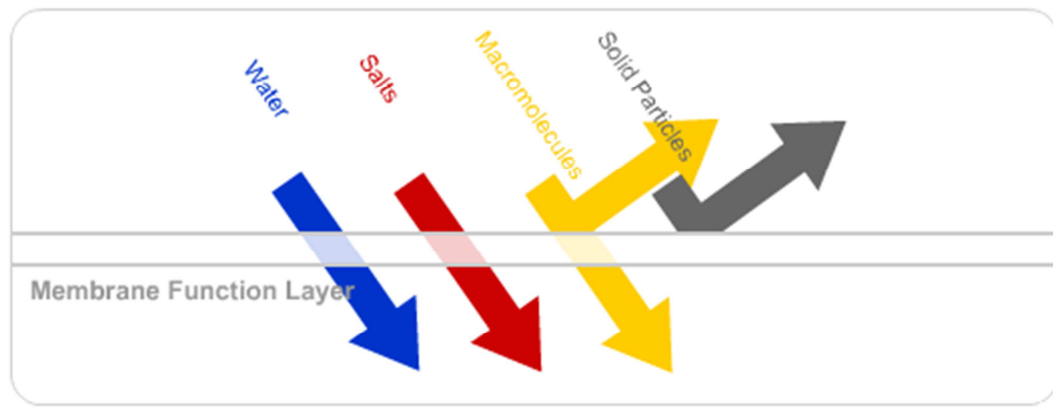

Figure 1.7.1-1. Schematic representation of MF membrane function layer.

### 1.7.2 Ultrafiltration

Ultrafiltration (UF) is the process of separating extremely small particles and dissolved molecules from fluids. The primary basis for separation is molecular size, although in all filtration applications, the permeability of a filter medium can be affected by the chemical, molecular or electrostatic properties of the sample. UF can only separate molecules which differ by at least an order of magnitude in size. Molecules of similar size can not be separated by UF. Materials ranging in size from 1KDa to 1000KDa molecular weight (MW) are retained by certain UF membranes, while salts and water will pass through. Colloidal and particulate matter can also be retained. Ultrafiltration membranes can be used both to purify material passing through the filter and also to collect material retained by the filter. Materials significantly smaller than the pore size rating pass through the filter and can be depyrogenated, clarified and separated from high molecular weight contaminants.



Materials larger than the pore size rating are retained by the filter and can be concentrated or separated from low molecular weight contaminants. UF is typically used to separate proteins from buffer components for buffer exchange, desalting, or concentration. Ultrafilters are also ideal for removal or exchange of sugars, non-aqueous solvents, the separation of free from protein-bound ligands, the removal of materials of low molecular weight, or the rapid change of ionic and/or pH environment. Depending on the protein to be retained, the most frequently used membranes have a nominal molecular weight limit (NMWL) of 3 kDa to 100 kDa and hydrostatic pressures of 0.1-0.5 MPa are used. Ultrafiltration is far gentler to solutes than processes such as precipitation. UF is more efficient because it can simultaneously concentrate and desalt solutes. It does not require a phase change, which often denatures labile species, and UF can be performed either at room temperature or in a cold room. The main hydrodynamic resistance of the membrane is offered by the top layer, while the supporting porous sub layer offers minimal hydraulic resistance. UF membranes are prepared by phase inversion. Materials used are PSf, PVDF, PAN, PEEK and cellulose such as cellulose acetate. Polymer blends, e.g. with polyvinylpyrrolidone (PVP) are commonly used to increase the hydrophilicity of the membranes. Also the UF process can be operated according to the dead-end and cross flow configurations. UF refers to a scale of separation between microfiltration and nanofiltration, used to purify, concentrate or fractionate macromolecules.

UF membranes reject or separate high molecular weight solutes as well as suspended solids, colloids, and macromolecules. Water and low MW dissolved solids such as salts and sugars pass readily through the membranes (*Figure 1.7.2-1*).

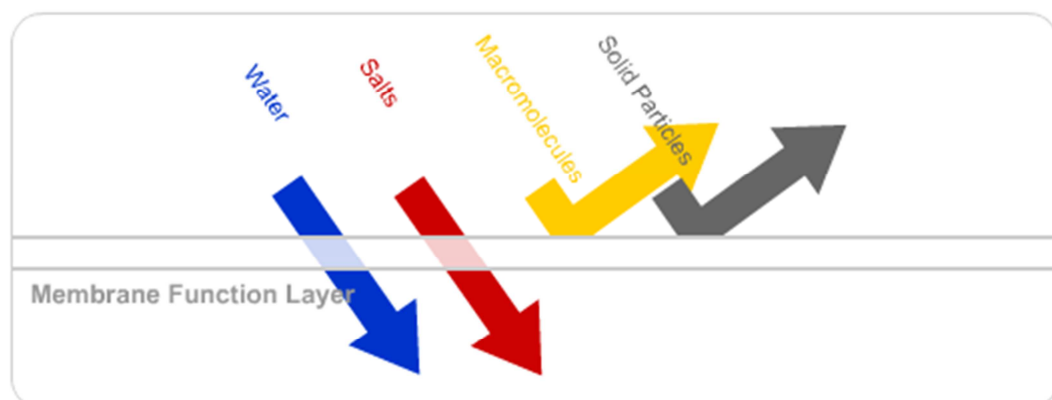

*Figure 1.7.2-1. Schematic representation of UF membrane function layer.*

Some UF membranes can reject particles having a molecular weight of about 1,000 MW, and a few manufacturers claim to make UF membranes which can reject a small percentage of low MW dissolved salts. However, most applications using UF membranes fall in the 10,000 to 100,000 MW ranges. Like MF membranes, the UF separation mechanism is commonly attributed to geometry, i.e. the opening or pore size of the membrane. While some specialty dead end cartridges are used, primarily in the pharmaceutical industry, UF separations are principally done in cross flow mode. Systems operate at a relatively low transmembrane pressure, 0.7 to 10.3bar. Generally, UF membranes require higher pressures than MF membranes because they are “tighter” and offer more resistance to liquid flow through the membrane.

UF is widely used for the recovery and concentration of enzymes and proteins produced by fermentations. The attraction of UF in protein concentration lies in the energy efficiency of the concentration of dilute fermentation broths and the gentle nature of separation which minimises protein denaturation, as the loss of protein activity. The addition of fining agents and then the decanting or filtering through pre-coat filter have been used in the traditional clarification of fruit juices. The application of UF simplifies the process by reducing time and labour and by increasing yield and juice quality [22]. UF is also used to remove particulate, microorganisms and colloidal material from drinking water and thus replaces conventional clarification and disinfection. The ability to separate soluble macromolecules from other soluble species and solvents is the major reason of the use of the UF in many industries such as pulp and paper industries [21].

UF membrane systems conserve energy with minimal operation and labour costs. The ability to retain high concentrates minimises disposal costs for a wide range of industries. In the bid to conserve water, using UF membrane systems to recycle water can yield zero discharge capabilities. Initial setup cost is low and minimal pretreatment chemicals are required compared to conventional systems.

### *1.7.3 Nanofiltration*

The development of nanofiltration (NF) membranes was fairly rapid during the 1970s and 1980s, leading to a “loose RO” membrane process, which was given the name “nanofiltration” at the end of the 1980s.

In this sense, then, NF is a fairly recent development in the range of membrane separation processes, which takes in the upper end (in separation size terms) of reverse

osmosis, and the lower end of ultrafiltration, covering MWCO values of 100 to 1000 Daltons. It deals with materials that are dissolved in a liquid, and not with distinct particles suspended in the liquid. The separation between solute and solvent occurs by diffusion of the molecules of the solvent through the mass of the membrane material, driven mainly by a high transmembrane pressure, and not through any physical hole (pore) in the membrane. Some of the solute molecules may also diffuse through the membrane, either by the process designer's intent, or because the solute has a finite (although very small) diffusion coefficient in the membrane material.

The key difference between NF and reverse osmosis is that the latter retains monovalent salts (such as sodium chloride), whereas nanofiltration allows them to pass, and then retains divalent salts such as sodium sulphate. The membrane separation process known as NF is essentially a liquid phase one, because it separates a range of inorganic and organic substances from solution in a liquid mainly, but by no means entirely, water. This is done by diffusion through a membrane, under pressure differentials that are considerable less than those for reverse osmosis, but still significantly greater than those for ultrafiltration. It was the development of a thin film composite membrane that gave the real impetus to NF as a recognized process with its unique ability to separate and fractionate ionic and relatively low molecular weight organic species. NF membranes are produced in plate and frame form, spiral wound, tubular, capillary and hollow fibre formats, from a range of materials, including cellulose derivatives and synthetic polymers, from inorganic materials, ceramics especially, and from organic/inorganic hybrids.

Recent developments of membranes for NF have greatly extended their capabilities in very high or low pH environments, and in their application to non-aqueous liquids. The plastic media are highly cross-linked, to give long-term stability and a practical lifetime in more aggressive environments. NF membranes tend to have a slightly charged surface, with a negative charge at neutral pH. This surface charge plays an important role in the transportation mechanism and separation properties of the membrane. As with any other membrane process, NF is susceptible to fouling, and so NF systems must be designed to minimize this phenomenon through a proper pretreatment, with the right membrane material, with adequate cross-flow velocities to scour the membrane surface clear of accumulated slime, and by use of rotating or vibrating membrane holders.

Industrial applications of NF are quite common in the food and dairy sector, in chemical processing, in the pulp and paper industry, and in textiles, although the chief application continues to be in the treatment of fresh, process and waste waters.

In the treatment of water, NF finds use in the polishing at the end of conventional processes. It cannot be used for water desalination, but it is an effective means of water softening, as the main hardness chemicals are divalent. At first sight, NF would not seem to have much place in MBR processes, because the higher transmembrane pressure differentials needed for NF are not available in most bioreactor systems, but there are some specialized uses for MBRs in which NF is finding a place. NF membranes are also used for the removal of natural organic matter from water, especially tastes, odors and colors, and in the removal of trace herbicides from large water flows. They can also be used for the removal of residual quantities of disinfectants in drinking water.

Food industry applications are quite numerous. In the dairy sector, NF is used to concentrate whey, and permeates from other whey treatments, and in the recycle of clean-in-place solutions. In the processing of sugar, dextrose syrup and thin sugar juice are concentrated by NF, while ion exchange brines are demineralised. NF is used for degumming of solutions in the edible oil processing sector, for continuous cheese production, in the production of alternative sweeteners and for the cholesterol removal [21]. In aqueous systems, NF uses hydrophilic polymeric materials, such as polyether-sulphone, polyamides and cellulose derivatives. These materials, in contact with organic solvents, quickly lose their stability. Special membranes have therefore been developed to provide the same kind of performance as in aqueous systems, and they are now used for solvent exchange, solvent recovery and separation, for catalyst recovery and for heavy metal removal. A schematic representation of a NF membrane functional layer is shown in figure 1.7.3-1.

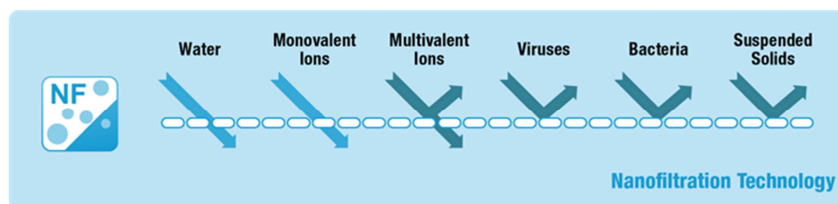

Figure 1.7.3-1 Schematic representation of a NF membrane function layer.

#### 1.7.4 Reverse osmosis

Reverse Osmosis (RO) and NF are two very similar technologies. In appearance they are virtually identical and both use essentially the same technology to remove impurities from water or other liquids. In both systems, membranes are used to separate a liquid from contaminants.

RO, also known as hyperfiltration, is the finest filtration known. This process will allow the removal of particles as small as ions from a solution. RO is used to purify water and remove salts and other impurities in order to improve the color, taste or properties of the fluid. It can be used to purify fluids such as ethanol and glycol, which will pass through the RO membrane, while rejecting other ions and contaminants from passing. The most common use for RO is in purifying water. It is used to produce water that meets the most demanding specifications that are currently in place.

RO uses a membrane that is semi-permeable, allowing the fluid that is being purified to pass through it, while rejecting the contaminants that remain. Most RO technology uses a process known as crossflow to allow the membrane to continually clean itself. As some of the fluid passes through the membrane the rest continues downstream, sweeping the rejected species away from the membrane. The process of RO requires a driving force to push the fluid through the membrane, and the most common force is pressure from a pump. The higher the pressure, the larger the driving force. As the concentration of the fluid being rejected increases, the driving force required to continue concentrating the fluid increases.

RO is capable of rejecting bacteria, salts, sugars, proteins, particles, dyes, and other constituents that have a molecular weight of greater than 150-250 daltons.

RO membranes can be made of cellulose triacetate, aromatic polyamide or interfacial polymerization of polyamide and poly (ether urea).

Over traditional evaporation the RO is characterized by low thermal damage to product, reduction in energy consumption and lower capital investments as the process is carried out at low temperatures and it does not involve phase change for water removal [22].

The filtration spectrum illustrating all pressure-driven membrane operations including RO, is depicted in Figure 1.7.4-1.

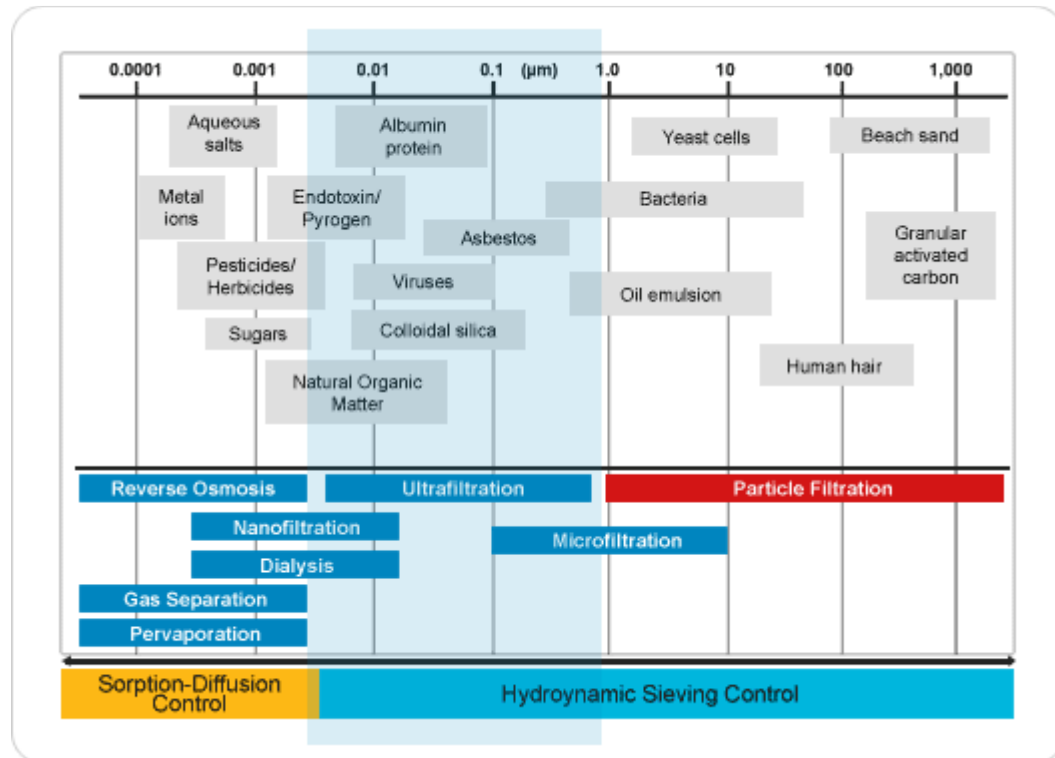

Figure 1.7.4-1 The filtration spectrum

### 1.7.5. Membrane distillation

Membrane distillation (MD) is a relatively new membrane separation process which might overcome some limitations of the more traditional membrane technologies. In particular, high solute concentrations can be reached and ultrapure water can be produced in a single step. The possibility of an industrial development of this technology is related to the growing commercial availability of membranes of potential interest. When a microporous hydrophobic membrane separates two aqueous solutions at different temperatures, selective mass transfer across the membrane occurs: this process takes place at atmospheric pressure and at temperatures which may be much lower than the boiling point of the solutions. The hydrophobicity of the membrane prevents the transport of the liquid phase across the pores of the partition while water vapor can be transported across them from the warm side, condensing at the cold surface. The driving force is the vapor pressure difference at the two solution membranes interfaces. Because the process can take place at normal pressure and low temperature, MD could be used to solve various wastewater problems, to separate and recover chemicals, and also to concentrate to high osmotic pressures aqueous solutions of substances sensitive to high temperatures. The possibility of using solar, wave or

geothermal energy, or existing low temperature gradients typically available in industrial processing plants is particularly attractive. The fundamental simplicity of traditional distillation is compromised by various factors such as the need for complete removal of all non condensable gases. The use of vacuum pumps, high pressure vessels, deaeration devices, etc. are required for removing the effects of the non condensable gases, with a significant energy consumption. A number of distillation processes have been proposed with the aim of eliminating the need for creating a vacuum [23]. Figure 1.7.5-1 shows the schematic representation of MD process.

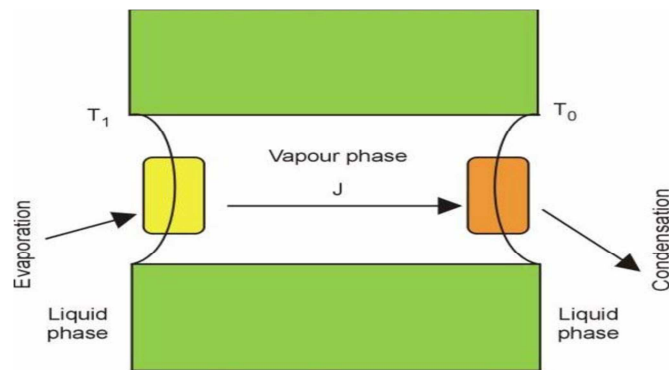

Figure 1.7.5-1 A schematic representation of the membrane distillation process:  $T_1$ , temperature at the hot side;  $T_0$ , temperature at the cold side;  $J$ , flux of the vapor phase.

The most suitable materials for MD membranes include PVDF, polytetrafluoroethylene (PTFE) and polypropylene (PP). The size of micropores can range between 0.2 and 1.0  $\mu\text{m}$ . The porosity of the membrane will range from 60% to 80% of the volume and the overall thickness from 80–250  $\mu\text{m}$ , depending on the absence or presence of support. Because MD can be carried out at the atmospheric pressure and at a temperature which can be much lower than the boiling point of the solution, it can be used to concentrate solutes sensitive to high temperature (e.g. fruit juices), also at high osmotic pressure. Therefore MD has received a great attention as a technique for concentrating fruit juices [24, 25].

### 1.7.6 Osmotic distillation

Osmotic distillation (OD) is a kind of mass transfer driven membrane process where the driving force is the vapour pressure difference between two solutions. Similar that membrane distillation (MD) in case of OD are also used hydrophobic, porous,

polymeric membranes. For the OD process usually high concentration of osmotic agent, mostly salt solution ( $\text{NaCl}$ ,  $\text{CaCl}_2$ ,  $\text{K}_2\text{HPO}_4$ ,  $\text{K}$ -acetate) or some kind of organic solutions (polyethylene-glycol, glycerol, etc.) are used which can keep and sustain very low value of vapour pressure during the process. These osmotic agents are able to perform the suitable vapour pressure difference with the high concentration and low vapour pressure value between the two solutions [26-28]. OD process is based on the use of two aqueous solutions which have different water activity and a microporous hydrophobic membrane between these solutions. Thus aqueous solutions cannot penetrate into the pores at the liquid-vapour interfaces. As a result, volatile compound molecules (water) evaporate from the higher water activity liquid-vapour interface (liquid food side), cross the pores by diffusion and condense at the lower water activity vapour-liquid interface (osmotic agent side). Figure 1.7.6-1 shows the flow sheet of the OD process [29-32].

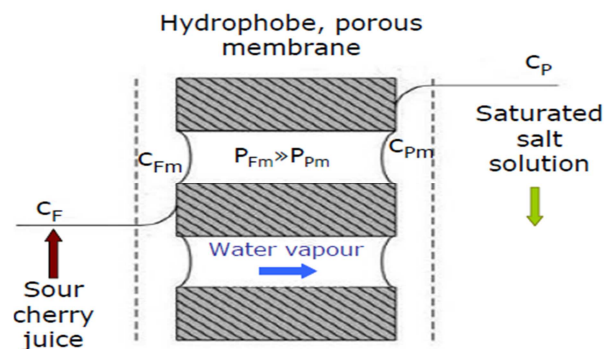

Figure 1.7.6-1 Schematic representation of OD

If the operating pressure is kept below the capillary penetration pressure of liquid into the pores, the membrane cannot be wetted by the solutions. OD has been successfully applied to the concentration of liquid foods such as milk, fruit and vegetable juice, instant coffee and tea and various non-food aqueous solutions. This technique can be used to extract selectively the water from aqueous solutions under atmospheric pressure and at room temperature, thus avoiding thermal degradation of the solutions. It is therefore particularly adapted to the concentration of heat-sensitive products like fruit juices.



As compared with RO and MD process, the OD process has the potential advantage which might overcome the drawbacks of RO and MD for concentrating fruit juice, because RO suffers from high osmotic pressure limitation, while in MD some loss of volatile components and heat degradation may still occur due to the heat requirement for the feed stream in order to maintain the water vapour pressure gradient. OD, on the other hand, does not suffer from any of the problems mentioned above when operated at room temperature [33].

**References**

1. Zeman, L.J. and Zydney, A.L. (1996) *Microfiltration and Ultrafiltration: Principles and Applications*, Marcel Dekker, New York, . .
2. Rios, G.M., Belleville, M.P., Paolucci-Jeanjean, D. (2007) *Membrane engineering in biotechnology: quo vamus?* Trends Biotechnol, 25 (6), 242-6.
3. Cassano, A., Drioli, E., Galavernab, G., Marchellib, R., Di Silvestroc, G., Cagnassoc, P. (2003) *Clarification and concentration of citrus and carrot juices by integrated membrane processes*, Journal of Food Engineering, 57 (2) 153-163.
4. Drioli, E. and Romano, M. (2001) *Progress and New Perspectives on Integrated Membrane Operations for Sustainable Industrial Growth*. Industrial & Engineering Chemistry Research, 40 (5), 1277-1300.
5. Drioli, E. and Curcio, E. (2007) *Membrane engineering for process intensification: a perspective*. Journal of Chemical Technology & Biotechnology, 82(3), 223-227.
6. Val, S.F. (2010) *Sea vs. Bay Water Desalination: Which One is for You?*, in *World Environmental and Water Resources Congress 2010*, American Society of Civil Engineers, 3542-3551.
7. Hashsham S.A. (2006) *Dead End Membrane Filtration Laboratory Feasibility Studies in Environmental Engineering* Spring
8. Strathmann H., Giorno, L., Drioli, E. (2006) *An introduction to membrane sciences and technology*, ed. D. E.: CNR. Roma.
9. Khulbe, K.C., Feng, C.Y., Matsuura, T. (2007) *Synthetic Polymeric Membranes: Characterization by Atomic Force Microscopy*: Springer.
10. Strathmann, H. (1984) *Synthetic membranes and their preparation*. In *Synthetic Membranes: Science, Engineering and Applications*, 1-37.
11. Druin, M.L., Loft, J.T., Plovan, S.G. (1974) *Novel open-celled microporous film*. U.S. Patent, 3, 801, 404.

12. Gore, R.W. (1976) *Process for Producing Porous Products*. U.S. Patent 3, 962, 153.
13. Riedel, C., Spohr, R. (1980) *Transmission Properties of Nuclear Track Filters*. *Membrane Science*, 7, 225-234.
14. Pellegrino, J.(2000) *Filtration and ultrafiltration equipment and techniques*. *Separation & Purification Reviews*, 29 (1), 91-118.
15. Katzir-Katchalsky, A., Curran, P.F. (1967) *Nonequilibrium thermodynamics in biophysics*, Harvard University Press.
16. Mulder, J. (1996) *Basic Principles of Membrane Technology*, Springer.
17. Association, A.M.T. (2007) *Membrane Separation Process*: Florida.
18. Yoon, S. (2011) *Membrane and module configuration*. [onlinembr.info](http://onlinembr.info).
19. De, D.S. (2011) *Membrane based separation processes*. NPTEL, MHRD, 11-17.
20. Ho, W. and Sirkar, K.(1992) *Membrane Handbook*, New York.
21. Allegre, C., Moulin, P., Gleize, B., Pieroni, G. , Charbit, F. (2006) *Cholesterol removal by nanofiltration: Applications in nutraceuticals and nutritional supplements*, *Journal of Membrane Science*, 269, 109–117.
22. Bruggen, B. V. D., Vandecasteele, C., Gestel, T. V., Doyen, W., Leysen, R. (2003) *A review of pressure-driven membrane processes in wastewater treatment and drinking water production*, *Environmental Progress*, 22 (1), 46-56.
23. Drioli,E., Cassano,A., Molero,L. P. (2012) *Water and wastewater treatment technologies*. membrane distillation. Vol. III.
24. Jiao, B., Cassano,A., Drioli,E. (2004) *Recent advances on membrane processes for the concentration of fruit juices: a review*. *Journal of Food Engineering*, 63 (3) 303-324.
25. Alvarez, S., Riera, F.A., Alvarez, R., Coca, J., Cuperus, F.P., Bouwer, S.Th., Boswinkel, G., van Gemert, R.W., Veldinsk, J.W., Giorno, L., Donato, L., Todisco, S., Drioli, E., Olsson, J., Tragardh, G., Gaeta, S.N., Panyor, L., *A new*

- integrated membrane process for producing clarified apple juice and apple juice aroma concentrate. Journal of Food Engineering, 2000. 46 (2) 109-125.*
26. Bailey, A.F.G., Barbea, A.M., Hogan, P.A., Johnson, R.A., Shenga, J. (2000) *The effect of ultrafiltration on the subsequent concentration of grape juice by osmotic distillation, Journal of Membrane Science, 164 (1), 195-204.*
  27. Cassano, A., Conidi, C., Timpone, R., D'Avella, M., Drioli, E. (2007) *A membrane-based process for the clarification and the concentration of the cactus pear juice. Journal of Food Engineering, 80 (3), 914-921.*
  28. Gostoli, C. (1999) *Thermal effects in osmotic distillation, Journal of Membrane Science, 163 (1), 75-91.*
  29. Bélafi-Bakó K. (2007) *From the osmotic power plant to semipermeable rain coat – membranes (In Hungarian). Magyar Tudomány, 1024-1033.*
  30. Courel, M., Dornier, M., Rios, G. M., Reynosa, M. (2000) *Modelling of water transport in osmotic distillation using asymmetric membrane. Journal of Membrane Science, 173 (1), 107-122.*
  31. Mansouri, J. and Fane, A.G. (1999) *Osmotic distillation of oily feeds. Journal of Membrane Science, 153 (1), 103-120.*
  32. Thanedgunbaworn, R., Jiratananon, R., and Nguyen, M.H. (2007) *Mass and heat transfer analysis in fructose concentration by osmotic distillation process using hollow fibre module, Journal of Food Engineering, 78 (1), 126-135.*
  33. Cassano, A., Jiao, B., and Drioli, E. (2004) *Production of concentrated kiwifruit juice by integrated membrane process. Food Research International, 37 (2) 139-148.*

## CHAPTER II

# GENERAL PROPERTIES OF CITRUS FRUITS

### 2.1 Introduction

Citrus is a common term and genus (*Citrus*) of flowering plants in the rue family, Rutaceae. Citrus is believed to have origin in the part of Southeast Asia bordered by Northeastern India, Myanmar (Burma) and the Yunnan province of China [1]. Citrus fruit has been cultivated in an ever-widening area since ancient times; the best-known examples are the oranges, lemons, grapefruit, and limes. Citrus fruits are probably the best known and most widespread fruits all over the world, particularly appreciated for their fresh flavour and considered of high beneficial value for their high content in vitamin C and natural antioxidants, such as flavonoids and phenylpropanoids.

Citrus fruits have long been valued as part of a nutritious and tasty diet. The flavours provided by citrus are among the most preferred in the world, and it is increasingly evident that citrus not only tastes good, but is also good for people. It is well established that citrus and citrus products are a rich source of vitamins, minerals and dietary fibre (non-starch polysaccharides) that are essential for normal growth and development and overall nutritional well-being. However, it is now beginning to be appreciated that these and other biologically active, non-nutrient compounds found in citrus and other plants (phytochemicals) can also help to reduce the risk of many chronic diseases. Where appropriate, dietary guidelines and recommendations that encourage the consumption of citrus fruit and their products can lead to widespread nutritional benefits across the population.

The genus *Citrus* includes several important fruits such as oranges, mandarins, limes, lemons and grapefruits. The sweet orange probably originated in Southeast Asia, from which it spread to Arabia and Southern Europe. It is, however, produced in all subtropical areas of the world. The mandarins are also believed to have originated in Southeast Asia. Lemons (*C. limon*) probably originated as hybrids between the citron and the lime and are native to Southeast Asia, perhaps Burma or Southern China. They were widely distributed in the Middle East and Southern Europe by the twelfth century,

from which they have spread to many countries. Limes probably originated in India and then spread to the Middle East and other tropical and subtropical countries. The Mexican or Key lime is a somewhat smaller and smoother type of the same species. The grapefruit, which is generally classed as a separate species (*C. paradisi*), is assumed to have originated in the West Indies, possibly as a seedling mutant from *Citrus maxima* or a hybrid of shaddock. The seedless cultivars with pink or red flesh are of commercial importance. The grapefruit is grown in many subtropical countries, including the United States (Florida and Texas), South Africa, and Israel [2] and is commonly used as a breakfast fruit.



*Figure 2.1-1 Citrus fruits*

## **2.2 World production**

Citrus is the second most important fruit in the world after apple, and accounts for the production of about 100 million tons with an area of cultivation spread over a massive 7.2 million hectares. It is a long-lived perennial crop and is grown in more than 100 countries across the world. The world production of all citrus fruits in 1980 was 56.61 million metric tonnes [3], while in 1990 it was 67.63 million metric tonnes [4]. The 1999/2000 Citrus production reached 70.8 million tons globally. Brazil, the United States and China continue to lead production and their combined output represent close to 60% of the world's total [5]. In 2007 the world production of all citrus fruits was about 115 million tonnes (Table 2.2-1).

Citrus fruits are produced all around the world. According to FAO data, in 2004, 140 countries produced citrus fruits. However, most production is concentrated in certain areas. Most citrus fruits are grown in the Northern Hemisphere, accounting for around 70% of total citrus production. Main citrus fruit producing countries are Brazil, the Mediterranean countries, the United States (where citrus fruits for consumption as fresh fruit are mainly grown in California, Arizona and Texas, while most orange juice is produced in Florida) and China. These countries represent more than two thirds of global citrus fruit production. Brazil contributes significantly to the world's orange production. Japan is the leading producer of mandarins. Spain, the United States, Brazil, Italy, China, and Argentina produce substantial quantities of mandarins. Lemons and limes are produced mainly in Italy, the United States, Mexico, India, and Argentina. Oranges contribute to 71% of the citrus fruit production in the world. In Italy the centre of Citrus growing is the South of the peninsula. Due to their favourable climatic conditions Sicily and Calabria are considered the “heart” of the Italian citrus fruit production.

Table 2.2-1 The representation list of most citrus producers of the world

Top ten total citrus fruits producers 2007 (Tonnes)						
Country	Grapefruit	Lemons and limes	Oranges	Tangerines, etc.	Other	Total
Brazil	72,000	1,060,000	18,279,309	1,271,000	-	20,682,309
China	547,000	745,100	2,865,000	14,152,000	1,308,000	19,617,100
USA	1,580,000	722,000	7,357,000	328,000	30,000	10,017,000
Mexico	390,000	1,880,000	4,160,000	355,000	66,000	6,851,000
India	178,000	2,060,000	3,900,000	-	148,000	6,286,000
Spain	35,000	880,000	2,691,400	2,080,700	16,500	5,703,600
Iran	54,000	615,000	2,300,000	702,000	68,000	3,739,000
Italy	7,000	546,584	2,293,466	702,732	30,000	3,579,782
Nigeria	-	-	-	-	3,325,000	3,325,000
Turkey	181,923	706,652	1,472,454	738,786	2,599	3,102,414
<b>World</b>	<b>5,061,023</b>	<b>13,032,388</b>	<b>63,906,064</b>	<b>26,513,986</b>	<b>7,137,084</b>	<b>115,650,545</b>
Source: Food And Agricultural Organization of United Nations: Economic And Social Department: The Statistical Division						

The rapid growth of the citrus fruit industry in the past 25 years is due largely to population increase and improved economic conditions in the consuming nations of the world, together with the rapid advance of agricultural sciences and technology of by-products. Also, because of the nutrition-conscious consuming public and the natural distinctive flavor of the citrus, the demand for citrus fruits and citrus products has increased and is likely to increase further.

Citrus fruit is fast becoming a staple food product in the daily diet of many people, and large consumption of citrus fruit is also attributed to other types of food and beverage industries which require the flavor of citrus. Citrus is most commonly thought of as a good source of vitamin C. However, like most other whole foods, citrus fruits also contain an impressive list of other essential nutrients, including both glycaemic and non-glycaemic carbohydrates (sugars and fibre), potassium, folate, calcium, thiamin, niacin, vitamin B<sub>6</sub>, phosphorus, magnesium, copper, riboflavin, pantothenic acid and a variety of phytochemicals. In addition, citrus contains no fat or sodium and, being a plant food, no cholesterol. The average energy value of fresh citrus is also low (Table 2.2-2), which can be very important for consumers concerned about putting on excess body weight. For example a medium orange contains 60 to 80 kcal, a grapefruit 90 kcal and a tablespoon (15 ml) of lemon juice only 4 kcal [6].

Table 2.2-2 The Nutritional facts about citrus fruit

	Orange	Grapefruit	Tangerine
Weight (g)	131	236	84
Energy (kcal)	62	78	37
Fibre content (g)	3.1	2.5	1.7
Ascorbic acid (mg)	70	79	26
Folate (mcg)	40	24	17
Potassium (mg)	237	350	132

Gutherie and Picciano, 1995.

The rise in citrus production is mainly due to the increase in cultivation areas and the change in consumer preferences towards more health and convenience food consumption. The world production of different types of citrus is depicted in Figure 2.2-1.



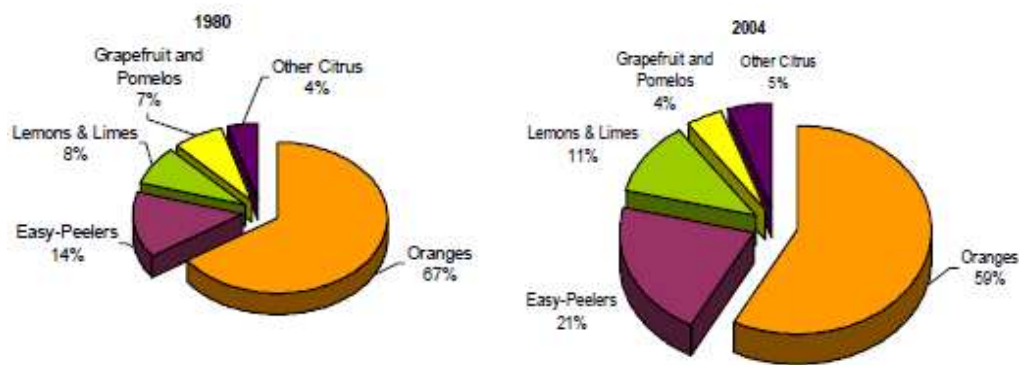

Figure 2.2-1 Global citrus production by type, 1980 and 2004

### 2.2.1 Soil and Climate

Citrus can grow well in a wide range of soils. It thrives well in deep, loose, well-aerated soils devoid of any hardpan layers of calcium carbonate in the rooting zones. Ideal pH for citrus is considered to be between 5.5 and 7.5. It is also highly sensitive to overly moist soil conditions within its root zone, while defective drainage causes nutritional imbalance. Citrus trees are susceptible to salt injury, and they cannot thrive in saline-alkaline soil. It appears that loamy soil with heavier subsoil or even heavy soil with good drainage can be ideal for citrus.

Citrus belongs to the tender subtropical group and thrives in frost-free subtropical to semitropical climates. Climatic factors such as temperature, moisture, wind, and light intensity are of principal importance for citrus, for which temperature plays a key role. Usually, a low temperature (-6.66 to -4.44°C) is considered to be injurious to young trees, while mature old trees are killed at a temperature of about -11.11 to -8.88°C. Different climatic factors influence both the vegetative growth of citrus plants as well as the productivity and physicochemical characteristics of the fruits [7].

### 2.2.2 Planting

Usually, citrus is planted in pits of 50 × 50 × 50 cm size in a square system with a spacing of 58 m depending on the species and rootstocks. Mandarin orange orchards are usually planted at a distance of 56 m. Though the planting is usually done during the monsoon (rainy) season, it is better not to plant at the time of heavy rains to avoid waterlogging near the planting pit. The weather should not be too dry at the time of planting.

### 2.2.3 Irrigation

Citrus trees can withstand a drought of 4 months if grown on deep soil with good water-holding capacity, especially if Rangpur lime is the rootstock. However, irrigation will be necessary if the dry season lasts longer than 3 months. The amount of water to be supplied depends on rainfall, evapotranspiration, and soil type. As a rule, the maximum amount is 100 mm at intervals of 3 weeks.

### 2.2.4 Manuring and fertilization

Citrus is a nutrient-loving plant, and about 15 elements have been known to have important roles to play for proper growth and development of citrus.

### 2.2.5 Resting or bahar treatment

Citrus trees normally set fruits in the fourth year. Flowers and fruits that may set earlier must be carefully removed before they develop, because the early bearing may weaken the plants. Flower initiation in sweet orange is presumably correlated with low levels or absence of flower inhibitors and follows a period of low temperature [8]. High temperature or presence of the previous season's fruits on trees is detrimental to the process of flower formation. Under the existing conditions, the flowering is stimulated by forcing the plants into rest by withholding irrigation. This rest or dormancy resulting from moisture stress is a substitute for the low-temperature treatment under tropical and subtropical conditions, which is known as bahar treatment. Application of 1000 ppm Cycocel in the second week of August and September to lime improves fruiting in following summer [8].

### 2.2.6 Fruit set and fruit drop

The use of bromouracil has been considered to stimulate flower formation in sweet oranges [9]. However, its use has remained of academic interest, since the concentration and number of applications and the cost makes its use unpractical for commercial purpose. Application of 2,4,5-trichlorophenoxyacetic acid (2,4,5-T) (15 ppm) at the time of first irrigation after the rest period is highly useful in stimulating flower formation in sweet orange [10]. Sometimes, flower inhibition to control biennial bearing (in trees of rootstocks from the Jambhiri group) becomes necessary. Two applications of gibberellic

acid (GA) at 10 ppm during the process of flower initiation have been observed to be useful in reducing the number of buds formed [9].

The process of fruit set in citrus is triggered by a rise in endogenous ethylene level [10]. GA applied at 10 ppm after the first set was observed to be useful in reducing the abscission process. However, the practical use of GA would depend on the magnitude and reliability of the response, and the cost in relation to additional income. Reduction in fruit drop is possible by application of alpha-naphthaleneacetic acid (NAA) (10 ppm) or 2,4,5-T (100 ppm), 21 days after fruit set [11]. Normal irrigation and plant protection practices are followed to reduce fruit drop of other nature. Fruit moth is one of the major causes of fruit drop, hence necessary insecticidal spray needs to be done in such cases.

### 2.2.7 Diseases and Pests

A great number of fungi, bacteria, mycoplasmas, viruses, insects, mites, and nematodes attack citrus. One of the most dangerous citrus enemies is the fungal genus *Phytophthora*. Its members cause foot rot, collar rot, crown rot, brown rot, root rot, gummosis on stems, blight of seedlings, and brown rot of fruit. Two other forms of fruit decay are important, stem-end rot and mold rot. The dieback and gummosis are caused by *Phytophthora palmivora* Butler. This malady was also attributed to tristeza virus infection alone and fungal complex. Recent studies, however, indicate that dieback of sweet orange is a complex phenomenon produced by the combination of viral, fungal, and mycoplasmal disorders. Three fungus diseases cause serious blemishes on leaves and fruits: meplanose, greasy spot, and scab. Citrus canker is a destructive bacterial disease in many countries. Tristeza is a viral disease transmitted by aphids. Greening is even more dangerous than tristeza, as no resistant rootstocks are known. *Exocortis* causes bark scaling, stunting, and certain leaf and twig symptoms. *Psorosis* is a whole complex of virus diseases [12-14].

Among insects, lemon butterfly (*Papilio spp*), leaf miner (*Phyllocnistis citrella* Stainton), Scales (*Chrysomphelus aonidum* L. Syn.), Psylla (*Daphorina citri*), citrus bark borer (*Inderbela quadrinotata* w.), citrus white fly (*Dialeurodes citri*), and fruit sucking moth (*Othris fullonica*) do most damage to citrus. Aphids (*Toxoptera citricidus*) transmit tristeza and cause injury to young leaves, shoots, and flowers. Mites

(*Panonychus citri* McGregor) and nematodes (*Tylenchulus semipenetrans* Cobb) are important pests of citrus.

### 2.3 Anatomorphology of citrus fruit

Citrus fruit arises through the growth and development of an ovary and consists of 8–16 carpels clustered around and joined to the floral axis, which forms the core of the fruit. Citrus fruit is composed of three distinctly different morphological parts. The pericarp (rind or peel) is divided into exocarp, or flavedo, and mesocarp, or albedo. Flavedo consists of the colored portion of the peel. In the flavedo are cells containing the carotenoids, which give the characteristic color to the different citrus fruits, i.e., orange, tangerine, grapefruit, lemon, etc. The oil glands, also found in the flavedo, are the raised structures in the skin of citrus fruits that contain the essential oils characteristics of each citrus cultivar [15]. Immediately under the epicarp is the mesocarp or albedo (Figure 2.3-1).

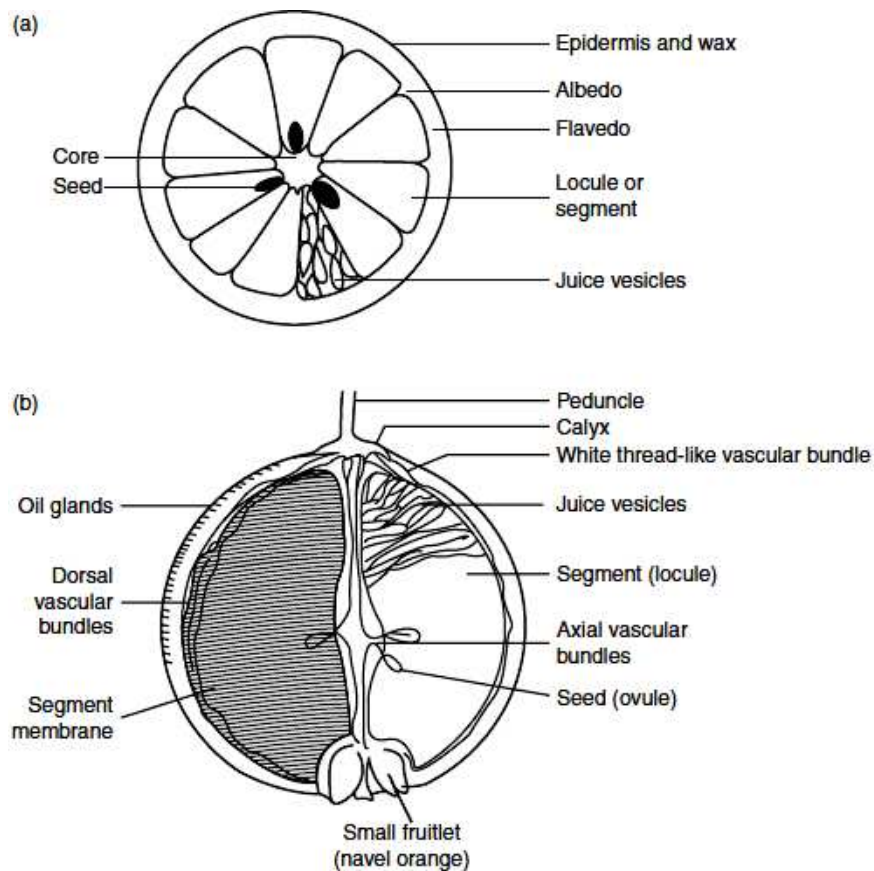

Figure 2.3-1 (a) Transverse section of citrus fruit showing various anatomical parts of citrus fruits and (b) longitudinal section showing vascular bundles and fruitlets of navel fruit.

This is typically a thick, white, spongy layer. The albedo consists of large parenchymatous cells that are rich in pectic substances and hemiceluloses. The combined albedo and flavedo are called the pericarp, commonly known as the rind or peel. The flavedo is the outer, colored part and the albedo is the inner, colorless (white) or sometimes tinted part (as in red grapefruit or blood oranges).

The edible portion of the citrus fruit, or the endocarp, is composed of many carpels or segments. Inside each segment are located the juice vesicles, which are attached to the segment membrane by the vesicle stalk. Many chemical constituents are distributed among the various tissues. Some are more concentrated in one tissue than another. For instance, flavanone glycosides are found in higher concentration in the albedo than in either the juice vesicle or the flavedo [16]; and the bitter compound limonin is highest in the seeds and membranes [17].

#### 2.4 Prevention potential of Citrus

There is considerable evidence that citrus foods may help reduce the risk, or retard the progression, of several serious diseases and disorders (Figure 2.4-1).

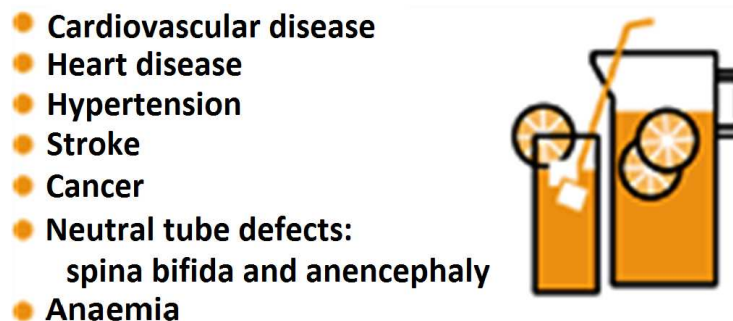

Figure 2.4-1 Prevention potential of citrus.

Diet is believed to play an important role in four major diseases of advanced economies: cardiovascular disease, cancer, hypertension, and obesity. The degree to which diet is important in the prevention of these diseases is not known. However, a commonly accepted estimate among experts is that at least one third of cancer cases can be attributed to diet and perhaps one half of the cases of heart and artery diseases and hypertension are related to diet [18, 19].

- *Cardiovascular disease*

It is well accepted that a diet low in saturated fat and cholesterol and rich in fruits and vegetables reduces the risk of heart disease. Epidemiological studies have also shown a significant association between vitamin C intake and protection against cardiovascular mortality, but the precise mechanism of protection is still unclear. One major culprit in the development of heart disease appears to be a high level of oxidized low-density lipoprotein (LDL), the so-called bad cholesterol. Significantly, a recent study has shown that high intakes of vitamin C (500 mg/day) obtained from the juice of freshly squeezed oranges, prevented a rise in the levels of oxidized LDL, even in the presence of a high-saturated fat diet [20].

A low dietary intake of folate contributes to the decrease of plasma folate and the raising of plasma homocysteine levels [21, 22]. Homocysteine is a toxic agent for the vascular wall and, when plasma levels rise above normal values, there is an increased risk of cardiovascular disease. An inverse dose-response relationship has been identified for fruit and vegetable intake and plasma homocysteine levels. Frequent consumption of folate-rich foods, such as oranges and orange juice, tends to increase plasma folate levels and, thus, lower homocysteine levels.

- *Cancer*

After numerous studies of fruit and vegetable intake and cancer development, there is a consensus that consuming these foods has a protective effect [23]. However, it is unlikely that one anticarcinogenic substance in particular is responsible for the benefit. There is reasonable scientific support for vitamin C's protective role in cancer. Many of animal, cell culture and human studies have suggested it has a positive effect. However, epidemiological studies provide good evidence that protective effects are more closely associated with the consumption of fruits and vegetables rather than with the enormous levels of vitamin C often used in cell culture and animal studies.

Recent news from researchers have demonstrated that oranges can play a significant role in preventing cancer. We know, for example, that the Mediterranean diet, which includes a considerable amount of citrus, is associated with a low incidence of cancers of the breast, lung, pancreas, colon, rectum, and cervix. Indeed, citrus fruits have been found to contain numerous known anticancer agents more than any other food.

The anticancer power of oranges is most effective when the whole fruit is eaten; it seems that the anticancer components of oranges work synergistically to amplify one another's effects. The soluble fiber, or pectin, which is so effective for heart health, is also an anticancer agent [24].

- *Neural tube defects*

During the first stage of pregnancy, adequate folate intake is critical for reducing the risk of severe birth defects, namely spina bifida and anencephaly. Public health recommendations in the United States include the consumption of 4 mg of folate per day for women of child-bearing age [25]. Regular consumption of citrus foods can help supply adequate folate and thus reduce the risk of these birth defects.

- *Anaemia*

Vitamin C can increase the absorption of non-haem iron (the inorganic iron form found in plant foods) two- to fourfold [26]. The bioavailability of non-haem iron is much lower than that of haem iron, which is found in foods of animal origin [6]. Vegetarians and individuals who consume little meat and animal products are at an increased risk of iron-deficiency, which can progress to anaemia over time. Worldwide, anaemia is one of the most serious nutrient-related public health problems, resulting in poor growth, impaired psychomotor development, reduced physical performance and decreased cognitive function. Consuming citrus fruits rich in vitamin C can help prevent anaemia and its devastating consequences.

- *Cataracts*

Oxidation of the eye's lens plays a central role in the formation of age-related cataracts. The role of dietary antioxidants, such as vitamin C, in the aetiology of cataracts has been a recent focus of research [27]. Lower cataract risk has been shown in individuals with high blood concentrations or intakes of vitamin C and carotenoids. There is now evidence to show that a high level of vitamin C intake over the long term decreases the risk of cataract development. Although epidemiological studies that measure past nutrient intake and status suggest a protective effect from citrus, further studies are

needed to examine the long-term benefits of citrus fruit consumption and cataract protection.

- *Bone metabolism and osteoporosis*

The influence of nutrient intake on bone density is an area of current research with many unanswered questions. Long-term intake of various foods may be important to bone health, possibly because of their beneficial effect on the acid base balance. Vitamin C intake has been associated with bone mineral density, but more work in this area is necessary to understand the mechanism of interaction. [28]

- *Kidney stone disease*

A kidney stone is a crystal structure formed by excessive salts in the urine. The most common type of stone is the calcium stone. A stone will increase in size until it is not passable and becomes lodged in the ureter. Stone symptoms include severe back pain, blood in the urine and fever. Stones strike men three to four times more often than women. Some people prone to stones have been found with insufficient levels of citrate in their urine and it has been suggested that eating citrus fruits and drinking orange juice may help prevent kidney stones by increasing urinary citrate. More research is needed in this area, but increasing fruit consumption is a nutritionally sound recommendation that may prove to be very beneficial for individuals at risk of certain kinds of kidney stones [29].

- *Cognitive function*

Elevated homocysteine levels are associated with cognitive dysfunction in the elderly. Older subjects with greater intakes of fruits and vegetables, and the corresponding nutrients vitamin C and folate, have been shown to perform better on cognitive tests [30]. The consumption of a satisfactory diet, containing nutrient-dense foods, appears to be associated with better cognitive function in the elderly. More research is needed to determine the effect of long-term citrus consumption on cognition.



- *Asthma*

Some studies suggest that a diet low in vitamin C is a risk factor for asthma [31]. Vitamin C is the major antioxidant substance present in the airway surface liquid of the lungs, where it could be important in protecting against oxidants. More research is needed to understand whether vitamin C and citrus consumption is protective in the causation and progression of asthma.

In addition, citrus by-products also represent a rich source of naturally occurring flavonoids: the peel, which represents almost one half of the fruit mass, contains high concentrations of flavonoids. In contrast with other types of fruit, citrus fruits can be consumed mostly fresh or pressed to obtain a juice. The majority of citrus fruits are preferably eaten fresh- oranges, mandarins, grapefruits, clementines and tangerines. Oranges and grapefruits produce a very palatable juice and hence make for nutritious and popular breakfast. Lemons and limes can be processed into lemonades and pickles, and their juices can be also added to various food preparations to enhance flavour [32].

## 2.5 Citrus biocompounds

The composition of citrus fruit is affected by such factors as growing conditions, maturity, rootstock, variety, and climate. In the process of juice extraction, as pressure and tearing forces are exerted upon the various tissues of the orange to varying degrees, the extracted juice contains substances from these tissues. Some of these elements may be responsible for undesirable changes occurring in processed orange juice, and a knowledge of these constituents of the fruit will be of value in helping to combat these changes [33].

Biocompounds present on citrus fruits are: proteins, lipids, sugars, acids, pectic substances, enzymes, flavonoids, bitter principles, peel oil, volatile constituents, vitamins, mineral constituents, ecc.

- *Proteins (nitrogenous constituents)*

The nitrogen content of whole citrus fruits varies between 0.1 and 0.2% on a wet basis. The nitrogenous constituents of citrus fruit include proteins, simple peptides, amino acids, phosphatides, and related substances. The proteins in citrus fruits are relatively

insoluble and are found to be associated with the solid portions of the fruit, such as seeds, flavedo, albedo, and pulp.

- *Lipids*

Oleic, linoleic, linolenic, palmitic, and stearic acids, glycerol, and a phytosterol in the pulp and locular tissues of California Valencias, have been reported [34]. The unsaturated fatty acids occupy a large percentage of the total fatty acids of the citrus seed oils. This fact makes citrus oil a desirable dietetic substitute for other unsaturated fats in food.

- *Sugars*

The sweetness of citrus fruits is due to the presence of glucose, fructose, and sucrose. The sugars may vary from 1% in certain lemons to nearly 9% in some oranges. The most important factor governing sugar content is maturity, especially with the sweeter kinds of citrus. In these, the acid content slightly decreases during maturity. In oranges, tangerines, and grapefruits, the soluble solids consist mainly of sugars, but in lemon and lime juice the soluble solids are mainly citric acid. In oranges, at maturity, the reducing and non reducing sugars are present in about equal amounts, but in less sweet fruits (lime), the reducing sugars predominate. Sugars also occur in albedo and flavedo.

- *Acids*

Citrus fruits are classed as acid fruits, as their soluble solids are composed chiefly of organic acids and sugars. The acidity of citrus juices is due primarily to citric and malic acid. Traces of tartaric, benzoic, oxalic, and succinic acids have also been reported [35]. The titratable acidity of oranges and grapefruits plays an important part in determining the maturity of these fruits.

- *Pectic Substances*

In addition to the soluble carbohydrates, citrus fruits contain insoluble carbohydrates that provide the structural materials and consist of roughly equal proportions of cellulose and pectin. Starch and lignin are absent. The peel is particularly rich in pectin, which may make up 20-40% of dry matter. The pectic substances in citrus juice are

important to the processing industry because of their function as cloud stabilizers in the juice. The tissues of citrus fruits have high contents of pectic substances, and they are used as a source of commercial pectin.

- *Enzymes*

Pectinesterase of citrus fruits occurs in great concentration in juice sacs and rag, with decreasing amounts in flavedo and albedo. Pectinesterase activity is believed to be one of the principal causes of cloud instability, known as cloud loss and gelation in unpasteurized citrus juices and frozen concentrates. Phosphatase occurs in the peel and also in solution in orange, grapefruit, and lemon juices.

- *Flavonoids*

Citrus fruits contain complex mixture of flavonoid compounds which include flavanone and flavone glycosides and also some highly methoxylated flavanones and flavones. The principal flavonoid in sweet oranges, mandarins, and lemons is hesperidin, while in grapefruit, naringin predominates.

Anthocyanins, flavones, flavonols, and flavanones are grouped under flavonoids. Flavonoids contain a C<sub>6</sub>-C<sub>3</sub>-C<sub>6</sub> carbon skeleton with sugar moiety (in glucosides). The major glycoside flavonoid in citrus are hesperidin, naringin, and neohesperidin. In general, concentration of flavanones decreases as fruit matures.

Hesperidin is a main flavonoid of oranges. It is not bitter in taste. Hesperidin is the 7- $\beta$ -rutinoside of hesperetin [16]. In hesperidin, the rhamnose and glucose are in the form of rutinose as a disaccharide moiety, and because of the rutinose, they are not bitter. Hesperidin is also found in mandarins, lemons, limes, and hybrids. The cloudiness of juice and marmalade made from oranges is due to precipitation of hesperidin, which is less soluble in water. Hesperidin can be found in the segment membrane in the form of white spots/crystals in freeze-damaged oranges and in the form of white specks in frozen concentrated orange juice. Citrus flavanones containing neohesperidose as disaccharide moiety are bitter, whereas, the flavanones containing the isomeric disaccharide rutinose (6-O- $\alpha$ -L-rhamnopyranosyl-Dglucose) are tasteless [36] (Figure 2.5-1).

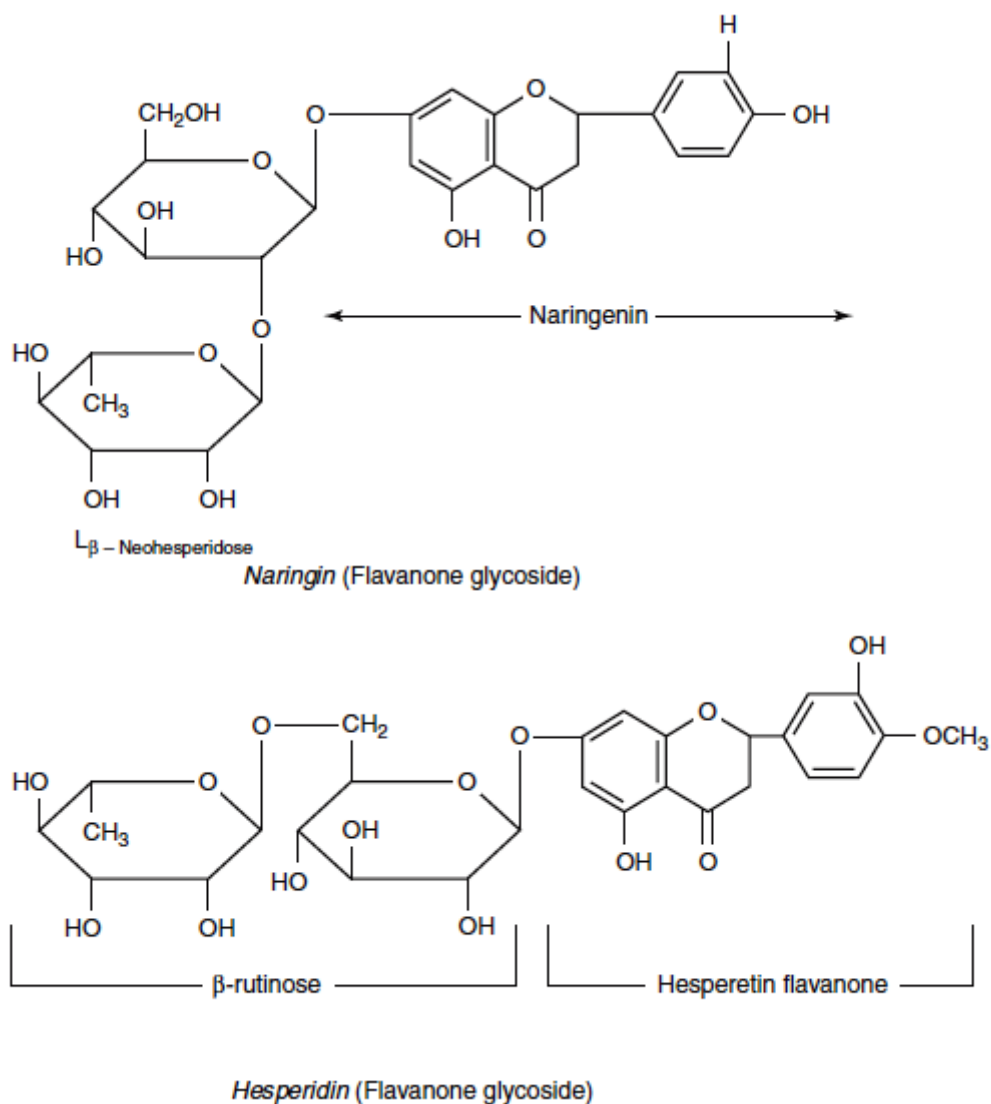

Figure 2.5-1 Important flavonoids (flavanone glycosides) of Citrus

- *Bitter Principles*

Some citrus juices have a tendency to develop bitterness. The bitterness is due to limonin and isolimonin. The bitter principles are present mainly in albedo, to a small extent in seeds, and slightly in the outer membranes of juice sacks. The limonin is water insoluble and is present in albedo in non bitter form, probably as glycoside at pH 4.5 or greater. During the extraction process of juice, the limonin may also be extracted and come in contact with the juice, the pH (3.6) of which is very suitable to convert glycoside of limonin to dilactone form, which is very bitter. It is generally known in the

processing industry that the juice of some varieties of oranges, such as Washington Navel, sometimes becomes unpalatably bitter a few hours after extraction. This bitterness is most intense with early fruit, and becomes less marked in more mature fruit. This phenomenon of delayed bitterness is due to the physical process of diffusion of limonin from the suspended solids into the juice. Because of the low solubility of limonin, heating or prolonged standing increases its concentration. The pronounced bitterness of some citrus flavonoids is due to naringin, the chief flavonoid constituent of the grapefruit and which also occurs in several types of oranges. Another flavonone glycoside with about one-tenth the bitterness of naringin is neohesperidin. It also contains neohesperidose. The aglycones are not bitter, nor is neohesperidose in the free form.

- *Volatile Constituents*

The most important volatile materials of citrus fruit are those associated with flavor and aroma. The volatile constituents of citrus juice (Table 2.5-1), which can be removed from the juice by distillation, consist of water-insoluble and soluble fractions. The predominant off-flavor in stored canned orange juice appears to come from nonvolatile precursors.

Table 2.5-1 Composition of Volatile Fraction of Orange Juice

Types of compound	Approximate number of identified constituents of the type	Example
Alcohols	54	Linalool, $\alpha$ -Terpineol, 4-Vinylguaiaicol Citronellol, Nerol, Octanol, Geraniol, Methanol, Ethanol
Aldehydes	41	Acetaldehyde, Hexanal, Citronellal, Geranial, Neral
Ketones	16	Carvone, Nootkatone, Acetone
Esters	39	Ethyl butyrate, Methyl butyrate, Ethyl -acetate, Linalyl acetate
Hydrocarbons	51	$\alpha$ -Pinene, Terpinolene, Valencene, Myrcene, Limonene
Acids	10	Acetic, Butyric
Others	12	Ethyl butyl ether, Linalool oxides

- *Peel Oil*

In the extraction of the juice, different proportions of oil may be extracted from peel. The main constituent of oil is d-limonene. A small amount of peel oil in fresh orange juice gives it a pleasant aroma and adds to the flavor. Under certain conditions, even the small amounts of oil in canned juice may give rise to objectionable flavors upon storage. Efforts to increase the yield of the juice may result in the possible contamination of the juice with peel juice constituent, which may contribute to bitterness or other off-flavors.

- *Pigments.*

The color of orange and tangerine juices is chiefly due to carotenes and xanthophylls. As chlorophyll in citrus peel decreases, carotenoids increase. In mature green fruit, xanthophylls predominate.

- *Vitamins*

The principal vitamin in citrus fruit is ascorbic acid or vitamin C. The amount varies with variety, maturity, and other factors. As the fruit matures, the vitamin C content gradually decreases. During the harvesting season, the vitamin C content ranges from 0.3 to 0.6 mg/ml [37]. Ascorbic acid is relatively stable in citrus product during processing and storage. As the storage temperature increases, ascorbic acid losses increase. In addition to ascorbic acid, citrus juices contain vitamin B complex and provitamin A (carotenoids). Other vitamins which have been reported are biotin, folic acids, pyridoxine, inositol, riboflavin, thiamine, and niacin.

- *Mineral constituents*

In common with other fruits, citrus fruits have a high content of potassium (100350 mg/100 g edible portion) and a low content of sodium (110 mg/100 g). Potassium accounts for 60-70% of the total ash content of the juice. The major portion of the calcium and magnesium is in a water-insoluble form combined with pectin. Potassium is an essential mineral that works to maintain the body's water and acid balance. As an important electrolyte, it plays a role in transmitting nerve impulses to muscles, in muscle contraction and in the maintenance of normal blood pressure. Potassium also

plays an important role to mental function as well as to physical processes. It helps to promote efficient cognitive functioning by playing a significant role in getting oxygen to the brain. The daily requirement of potassium is approximately 2000 mg and, while frank deficiency of potassium is rare, there is some concern that a high sodium-to-potassium intake ratio may be a risk factor for chronic disease.

Increased consumption of citrus fruits and juices is a good means of increasing potassium intake. One medium orange and a 225 ml glass of orange juice provide approximately 235 mg and 500 mg of potassium, respectively [6].

Magnesium may play an important role in regulating blood pressure. Diets that provide plenty of potassium and magnesium are consistently associated with lower blood pressure. Magnesium deficiency can cause metabolic changes that may contribute to heart attacks and strokes, as well as an increased risk of abnormal heart rhythms. Population surveys have associated higher blood levels with lower risks of coronary heart diseases. The recommended daily allowance for an adult is in the range 380-420 mg of magnesium for day [38].

## References

1. Gmitter, F., Hu, X. (1990) *The possible role of Yunnan, China, in the origin of contemporary citrus species (rutaceae)*. Economic Botany, 44 (2), 267-277.
2. Ryall, A.L., Lipton, W.J., Pentzer, W.T. (1972) *Handling, Transportation, and Storage of Fruits and Vegetables: Vegetables and melons*, AVI Publishing Company Inc, 1 (2), 587.
3. FAO, *Production Yearbook*. Food and Agriculture Organization, 1980. 34.
4. FAO, *Production Yearbook*. Food and Agriculture Organization, 1990. 44.
5. Johnson, D.T.M.. (2001) *Citrus Juice Production and Fresh Market Extension Technologies*, FAO,: p. 140.
6. Whitney, E., Whitney, E.N., Rolfes, S.R.. (2010) *Understanding Nutrition*, Wadsworth Publishing, Florida..
7. Salunkhe, D.K. Kadam, S.S. (1995) *Fruits in human nutrition*, in Handbook of Fruit Science and Technology, (Salunkhe, D.K. Kadam, S.S.), Marcel Dekker inc., New York.
8. Moss, G. (1976) *Temperature effects on flower initiation in sweet orange (Citrus sinensis)*, Australian Journal of Agricultural Research, 27(3), 399-407.
9. Moss, G. (1970) *Chemical control of flower development in sweet orange (Citrus sinensis)*, Australian Journal of Agricultural Research, 21(2), 233-242.
10. Moss, G. (1973) *Regrowth and flowering in sweet orange after pruning*. Australian Journal of Agricultural Research, 24(1), 101-109.
11. Anonymous. 1981 Annual report. *All India Coordinated Fruit Improvement Project on Citrus*, on Shrirampur, Ahmednagar, Maharashtra, India.
12. Uppal, B.N., Kamat M.N. (1936) *Gummosis of citrus in Bombay State*, Indian Journal of Agricultural. Sciences, 6, 72.
13. Capoor, S.P. (1983) *Decline of citrus trees in India*. Bull. Natl. Inst. Sci., 24, 48.
14. Raychaudhuri, S.P. (1973) Epiphytology of the Greening Disease of Citrus in India: Final Technical Progress Report, *Division of Mycology and Plant Pathology, Indian Agricultural Research Institute, India*.
15. Izquierdo, L., Sendra, J.M. (1993) *Citrus: Composition and characterization*. Encyclopaedia of Food Science, Food Technology and Nutrition, 999.



16. Hendrickson, R., Kesterson, J.W. (1964) *Hesperidin in Florida oranges*. Technical bulletin /Agricultural experiment stations. University of Florida.
17. Scott, W.C. (1970) *Limonin in Florida citrus fruits*, Proceedings of the florida state horticultural society,83, 270.
18. Goldberg, I. (2010) *Functional Foods: Designer Foods, Pharmafoods, Nutraceuticals*. Springer, Berlin.
19. Silalahi, J. (2002) *Anticancer and health protective properties of citrus fruit components*. Asia Pacific Journal of Clinical Nutrition, 11(1), 79-84.
20. Harats, D., Chevion, S., Nahir, M., Norman, Y., Sagee, O., Berry, E.M. (1998) *Citrus fruit supplementation reduces lipoprotein oxidation in young men ingesting a diet high in saturated fat: presumptive evidence for an interaction between vitamins C and E in vivo*, The American Journal of Clinical Nutrition, 67(2), 240-5.
21. Bloom, H. (1998) *Determinants of plasma homocysteine*. American Journal of Clinical Nutrition, 67, 188-189.
22. Tucker, K.L., Selhub, J., Wilson, P.W., Rosenberg, I.H. (1996) *Dietary intake pattern relates to plasma folate and homocysteine concentrations in the Framingham Heart Study*, Journal of Nutrition, 126 (12), 3025-31.
23. Block, G., Patterson, B., Subar, A. (1992) *Fruit, vegetables, and cancer prevention: a review of the epidemiological evidenc*. Nutrition and Cancer-an international journal, 18 (1), 1-29.
24. Miyazawa, M., Okuno, Y., Fukuyama, M., Nakamura, S., Kosaka, H. (1999) *Antimutagenic activity of polymethoxyflavonoids from Citrus aurantium*. Journal of Agricultural and Food Chemistry, 47 (12), 5239-44.
25. No authors listed. *Recommendations for the use of folic acid to reduce the number of cases of spina bifida and other neural tube defects*. MMWR Morb Mortal Wkly Report., 1992, 41 (14), 1-7.
26. Fleming, D.J., Jacques, P.F., Dallal, G.E., Tucker, K.L., Wilson, P.W., Wood, R.J. (1998) *Dietary determinants of iron stores in a free-living elderly population: The Framingham Heart Study*, The American Journal of Clinical Nutrition, 67 (4), 722-33.
27. Jacques, P.F., Taylor, A., Hankinson, S.E., Willett, W.C., Mahnken, B., Lee, Y., Vaid, K., Lahav, M. (1997) *Long-term vitamin C supplement use and prevalence of early age-related lens opacities*, The American Journal of Clinical Nutrition, 66 (4), 911-6.

28. New, S.A., Bolton-Smith, C., Grubb, D.A., Reid, D.M., (1997) *Nutritional influences on bone mineral density: a cross-sectional study in premenopausal women*. The American Journal of Clinical Nutrition, 65 (6), 1831-9.
29. Economos, C and Clay, W.D. (1998) *Nutritional and health benefits of citrus fruits*. Twelfth Session of the Intergovernmental Group on Citrus Fruit, Valencia.
30. Ortega, R.M., Requejo, A.M., Andrés, P., López-Sobaler, A.M., Quintas, M.E., Redondo, M.R., Navia, B., Rivas, T. (1997) *Dietary intake and cognitive function in a group of elderly people*, The American Journal of Clinical Nutrition, 66 (4), 803-9.
31. Hatch, G.E. (1995) *Asthma, inhaled oxidants, and dietary antioxidants*. The American Journal of Clinical Nutrition, 61(3 Suppl), 625S-630S.
32. Singh, S., Rajam, M. (2009) *Citrus biotechnology: Achievements, limitations and future directions*. Physiology and Molecular Biology of Plants, 15 (1), 3-22.
33. Mathur, M.M., Godara, P.S. (1990) *Physicochemical studies of some citrus species grown in arid and irrigated regions of Rajasthan*, Haryana Journal of Horticultural Sciences, 19 (3-4), 251-255.
34. Cameron, J.W. & Frost, H.B. (1968) *Genetics, breeding and nucellar embryony*. In W. Reuther, L.D. Batchelor & H.J. Webber, eds. *The citrus industry*, vol. II. 325-370 Anatomy, physiology, genetics and reproduction, Berkeley, Div. Agric. Sci., Univ. Calif.
35. Sinclair, W.B., Bartholomew, E.T., Ramsey, R.D. (1945) *Analysis of the organic acids orange juice*. Plant Physiology, 20 (1), 3-18.
36. Ameer, B., Weintraub, R.A., Johnson, J.V., Yost, R.A., Rouseff, R.L. (1996) *Flavanone absorption after naringin, hesperidin, and citrus administration*, Clinical Pharmacology and Therapeutics, 60 (1), 34-40.
37. Harding, P.L., Winston, J.R., Fisher, D.F. (1940) *Seasonal changes in Florida oranges*, US Department of Agriculture Technical Bulletin, 753, 89.
38. Shand, M.A., *The Chemistry and Technology of Magnesia*. (2006) Wiley-Interscience, 1 edition, New Jersey.

## CHAPTER III

# CLARIFICATION OF BLOOD ORANGE JUICE

### 3.1 Introduction

Citrus fruits represent a potential material for food and pharmaceutical industry since they contain a number of secondary metabolites that are bioactive in citrus, e.g. flavonoids, most of which exist in the form of flavanone glycosides, namely, naringin, hesperidin and neohesperidin [1-3]

Sweet oranges (*Citrus sinensis* L.) are a very important species of Citrus. They are classified according to the color of the pulp as either blonde or blood (red) oranges. The latter are commonly cultivated in the Mediterranean area, but the Sicilian ones, which account for around 60% of the Italian orange harvest, express a better quality due to the special pedoclimatic characteristics of the area [4]. Blood oranges have a pleasant taste and are distinguished among the sweet oranges by the rich burgundy color of the flesh and sometimes of the peel.

The red color of blood oranges is primarily associated with anthocyanin pigments [5] not usually found in citrus but common in berry fruits, represented mainly by cyanidin-3-glucoside and cyanidin-3-(6''-malonyl)- glycoside [6] (Figure 3.1-1).

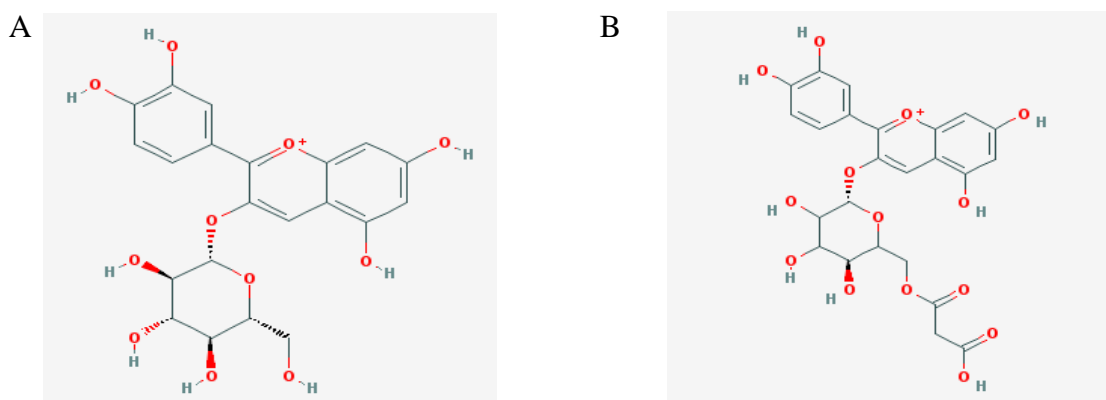

Figure 3.1-1 (A) Anthocyanins structure;  
(A) cyanidin-3-glucoside (B) Cyanidin 3-(6''-malonyl)glucoside

They contain also alkaloids (mainly synephrine, tyramin and octopamine) and hydroxycinnamic acids including ferulic, p-coumaric, chlorogenic and caffeic acids [7-9]. Each group of these compounds has a special biological activity. For example, flavonoids and hydroxycinnamic acids possess potent antioxidant property [9, 10], anticarcinogenic activity [8, 11-13] and free radical scavenging activity [14]. Fresh blood orange juice is particularly successful on the market because of its taste and nutritional value [15]. For this juice heat and oxidative damage may be measured by determining ascorbic acid and anthocyanin contents, which are dependent upon both orange variety and process operating conditions.

Studies on preliminary treatments of oranges, stabilisation operations and packaging materials have been carried out to improve product quality. Moreover, many efforts are involved in the preservation of components which are active in conferring protection against major diseases, for improving quality of life in a non-pharmacological way [16-23].

Membrane processes are consolidated systems in various productive sectors thanks to their capacity to operate at room temperature, moderate pressures and, consequently, with low energetic consumption. They are a valid alternative to classical processes, such as pasteurization and vacuum evaporation, which significantly change the quality of fresh fruit and vegetable juices. Pressure-driven membrane operations such as microfiltration (MF), ultrafiltration (UF), nanofiltration (NF) and reverse osmosis (RO) have been successfully used to clarify, fractionate and concentrate fruit juices and plant extracts [24-27]. Permeate fluxes and selectivities in the UF processes are a depend strongly on the operating and fluid-dynamic conditions, the nature of the membrane and the nature of the feed solutions. Although the transmembrane pressure (TMP) is the driving force for permeation, the flux increases with pressure up to a limiting value ( $TMP_{lim}$ ) which depends on physical properties of the feed to be filtered and cross-flow velocity. This latter affects the shear stress at the membrane surface and consequently the rate of removal of deposited matter responsible of flux decay [28].

The aim of the experimental activities was to evaluate the potential of the UF membrane process in the production of formulations of interest for food and pharmaceutical industries starting from the blood orange juice produced in the Calabria region. The

blood orange juice, after a depectinization step, was submitted to the clarification procedure based on the use of hollow fiber UF membranes.

The effect of the blood orange juice ultrafiltration on permeate fluxes and quality of the clarified juice in terms of suspended solids content, total soluble solids (TSS), phenolic compounds and total antioxidant activity (TAA) was evaluated and discussed.

## 3.2 Materials and methods

### 3.2.1 Blood orange juice

Blood oranges of *Tarocco* variety from Corigliano Calabro (Cosenza, Calabria) were used to prepare the juice. After a preliminary operation of washing and drying, the fruits were cut crosswise and squeezed using a household electric juice extractor. The squeezed juice was depectinised by using a pectolytic enzyme (Pectinex Ultra SPL, Sigma-Aldrich, Milan) which was added in quantity of 20 mg/L; then the juice was incubated for 4 hours at room temperature in plastic tanks with a capacity of 5 liters. The juice was finally filtered through a cotton fabric filter and then stored at -17°C. It was defrosted to room temperature before the UF treatment.

The extracting procedure from the blood oranges gave an average juice yield of 54% (w/w). The TSS content of the raw juice was about 10.5-11 °Brix with a pH of 3.5.

### 3.2.2 UF equipment and procedures

UF of blood orange juice was performed by using a bench laboratory plant. The UF equipment consisted of a 5 litres feed tank, a gear pump, the UF membrane module, a thermometer, two manometers for the measure of the inlet ( $P_{in}$ ) and outlet ( $P_{out}$ ) pressures and a pressure control valve. A cooling coil fed with tap water was used to maintain constant the feed temperature. A digital balance, connected to the system, was used to measure the permeate flux. A schematic representation of the UF bench plant is shown in Figure 3.2.2-1.

The plant was equipped with an UF hollow fibre membrane module (DCQ III-006C, polysulphone, 0.16 m<sup>2</sup>) supplied by China Blue Star Membrane Technology Co., Ltd. (Beijing, China).

UF experiments were performed according to the batch concentration mode collecting separately the permeate and recycling the retentate in the feed tank of the UF plant.

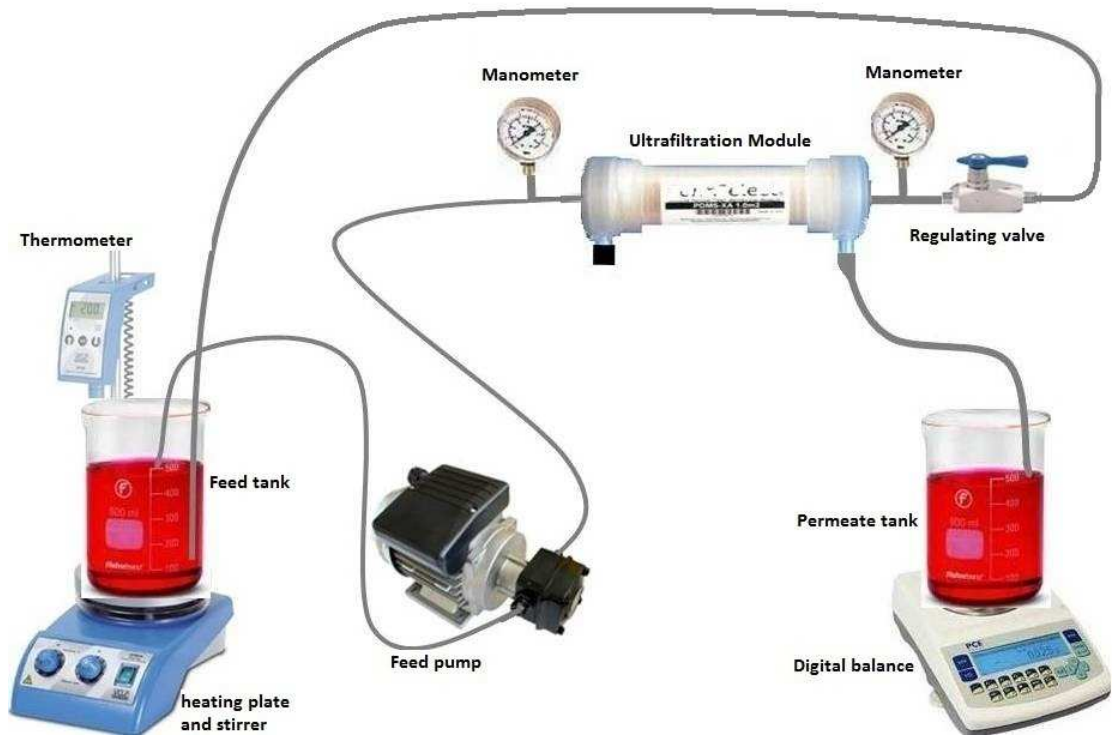

Figure 3.2.2-1 Scheme of the UF bench plant.

The UF system was operated at a TMP of 0.8 bar, at an axial feed flow rate ( $Q_f$ ) of 106 l/h and at a temperature of  $20 \pm 1^\circ\text{C}$  to clarify the juice up to a volume reduction factor (VRF, defined as the ratio between the initial feed volume and the volume of the resulting retentate) of about 3.8 units. The clarification process produced two fractions: a clarified juice (permeate) and a fibrous concentrated pulp (retentate).

### 3.2.3 UF hollow fibre membrane module and characteristics

The UF hollow fibre membrane module is depicted in Figure 3.2.3-1. In Table 3.2.3-1 characteristics of the membrane module are summarized.



Figure 3.2.3-1 UF hollow fibre membrane module.

Table 3.2.3-1 Characteristics UF hollow fibre membrane

Configuration	Hollow fiber
Membrane material	Polysulphone
Dimension (mm)	50 x 330
Operating pressure (bar)	1-1.5
Operating Temperature (°C)	5-45
Operating pH	2-13
Inner fiber diameter (mm)	2.1
Membrane area (m <sup>2</sup> )	0.16
Nominal molecular weight cut-off	100 kDa

#### 3.2.4 Measurement of hydraulic permeability and membrane cleaning

The UF hollow fibre membrane module was characterized for its water permeability. The hydraulic permeability was determined by feeding distilled water to the module and measuring the volume of permeate collected in a certain time through the surface membrane area at different transmembrane pressures (TMPs).

The water flux ( $J$ ), was determined by measuring the volume of permeate ( $V_p$ ) collected in a certain time ( $t$ ) through the membrane surface area ( $A$ ), maintaining constant the feed flow rate and the feed temperature:

$$J = \frac{V_p}{tA}$$

The slope of the straight line obtained by plotting the water flux against the applied TMP, gives the measure of the water permeability [29].

The hydraulic permeability of the membrane module in the same fixed conditions was measured after each experimental run and after each cleaning treatment in order to evaluate the effect of the juice treatment on the membrane fouling.

After the experiments with the juice the membrane module was cleaned in two steps. The first cleaning step was performed with tap water for 15 min to remove juice residues from the membrane module and then recirculating distilled water for 30 min through the module at high flow rate and low TMP in order to remove the reversible polarized layer. In the second step the membrane module was submitted to a cleaning procedure using the following solutions:

- NaOH solution (Carlo Erba, Milan) at 0.5 w/w%;
- Enzymatic solution (Ultrasil 50, Henkel, Dusseldorf) at 1.0 w/w%.

Cleaning solutions were recirculated in the UF plant for 60 min at 40°C. At the end of each cleaning procedure the membrane module was rinsed with distilled water and the hydraulic permeability was measured.

### 3.2.5 Analytical measurements

Samples of depectinised juice (feed UF), clarified juice (permeate UF) and concentrated juice from the UF treatment (retentate UF) were collected and stored at -17°C for further analyses.

The rejection (R) of the UF membrane towards specific compounds was determined as:

$$R = \left(1 - \frac{C_p}{C_f}\right) \cdot 100$$

where  $C_p$  and  $C_f$  are the concentration of a specific component in the permeate and feed, respectively.

#### 3.2.5.1 Total soluble solids (TSS)

TSS measurements were carried out by using hand refractometers (Atago Co., Tokyo, Japan) with scale range of 0-32, 28-62 and 58-90 °Brix.

#### 3.2.5.2 Total suspended solids

The suspended solids content was determined in relation to the total juice (w/w%) by centrifuging, at 2000 rpm for 20 min, 20 ml of a pre-weight sample; the weight of settled solids was determined after removing the supernatant.

#### 3.2.5.3 Conductivity

Conductivity measurements on blood orange juice, clarified juice and UF retentate samples were performed by using a FiveEasy FE30 Benchtop conductivity meter supplied by Mettler Toledo (Polaris Parkway, Columbus, USA); results were expressed as  $\mu\text{S}/\text{cm}$ .



#### 3.2.5.4 Total antioxidant activity

Total Antioxidant Activity (TAA) was determined by an improved version of the 2,2'-azino-bis-(3-ethylbenzothiazoline-6-sulfonic acid) (ABTS) free radical decolourisation assay [30] in which the ABTS radical cation is generated by reaction with potassium persulphate ( $K_2S_2O_8$ ) before the addition of the antioxidant. The decolouration of the blue/green  $ABTS^+$  chromophore (radical cation) is measured as the percentage of inhibition of absorbance at 734 nm and it is referred to the reactivity of Trolox (6-hydroxy-2,5,7,8-tetramethylchroman-2-carboxylic acid), an analogous of vitamin E. Spectrophotometric measurements were performed by using an UV-160 UV-visible recording spectrophotometer (Shimadzu Scientific instruments, Inc., Japan) at 30 °C. The percentage of inhibition (%I) was calculated as:

$$\% I = \left( \frac{A_{ABTS} - A_{SAMPLE}}{A_{ABTS}} \right) \cdot 100$$

Where  $A_{ABTS}$  is the mean value between initial and final absorbance of the  $ABTS^+$  working solution and  $A_{SAMPLE}$  is the absorption value after 5 min of contact between the antioxidant and the ABTS solution.

A 2mM ABTS solution was prepared by dissolving the ABTS in distilled water. The ABTS radical cation ( $ABTS^+$ ) was produced by reacting 50 ml of ABTS, (diammonium salt, minimum 98%, Sigma Aldrich, Milan) with 500  $\mu$ l of 70 mM potassium persulfate (minimum 99,0%, Sigma Ultra, Milan) solution and allowing the mixture to stand in the dark at room temperature for 6 h before use. The radical was stable in this form for more than two days. The work solution was prepared by diluting 1 ml of the  $ABTS^+$  solution to 25 ml with phosphate buffer saline (PBS) (5mM  $NaH_2PO_4$ , 5 mM  $Na_2HPO_4$ , 9 g/l NaCl) to a final UV absorbance of  $0.70 \pm 0.02$  at 734 nm.

Different samples coming from the UF process were diluted with PBS buffer according to the following procedure:

- 40  $\mu$ l of sample + 960  $\mu$ l of PBS buffer;
- 80  $\mu$ l of sample + 920  $\mu$ l of PBS buffer;
- 120  $\mu$ l of sample + 880  $\mu$ l of PBS buffer.

After this procedure samples were analysed according to the following method: addition of 1 ml of diluted ( $ABTS^+$ ) solution to 10  $\mu$ l of diluted sample; the absorbance reading

was registered exactly 1 min after the initial mixing and up to 6 min. The absorbance value at 6 min was used to calculate the results reported as total antioxidant activity and expressed as mM trolox equivalent. Each determination was performed in triplicate. Results were expressed as means  $\pm$  SD of three samples.

#### 3.2.5.5 Determination of phenolic compounds

Phenolic compounds were determined by HPLC. UF permeate fractions were directly injected, whereas retentate UF were previously centrifugated at 5000 rpm for 15 min, in order to remove the pulp fraction. HPLC analyses of phenolic compounds were performed by using a Shimadzu HPLC system, equipped with two SCL-10-AVP pumps, an SLC-10-AVP controller, and an SPD-20A UV/Vis detector. Analyses were performed with a C<sub>18</sub> RP-column (150 mm x 4.6 mm id, 5 $\mu$ m particle size) (Supelco). The solvent system used was a gradient of solvent A (water with 0.1% H<sub>3</sub>PO<sub>4</sub>) and solvent B (acetonitrile) at a flow rate of 1 mL/min. Gradient elution was performed as follows: 0-25 min, linear gradient from 15 to 40% solvent B; 25-35 min, linear gradient from 40 to 60% solvent B; 35-40 min, linear gradient from 60 to 70% solvent B; in additional 5 min the column was then reconditioned with the initial eluent. The detector was set at 284 nm to detect hydroxybenzoic acids and flavanones at 325 nm to detect hydroxycinnamic acids. The separated phenolic compounds were identified comparing their retention times with authentic compounds. Quantitative determination was carried out by using the external standard method. Calibration curves were constructed with the external standards.

#### 3.2.5.6 UHPLC–DAD–ESI–MS<sub>n</sub> analysis

Samples, with and without alkaline hydrolysis, undiluted and centrifugated (fresh juice and UF retentate) were analysed in a Thermo Accela UHPLC system (Thermo Scientific, San Jose, CA, USA) equipped with pump, autosampler and photodiode array detector (DAD) using a Hypersyl gold RP column (Thermo Scientific; 150 mm x 2.1 mm i.d.; particle size 1.9  $\mu$ m) at 30°C. The eluents used were water/acetonitrile/ acetic acid (99:1:0.1, v/v/v) (eluent A) and acetonitrile/acetic acid (100:0.1, v/v) (eluent B). The elution program (elution condition I) was 0-5 min, 0% B; 5-23 min, 0-60% B; 23-24 min, 60- 100% B; 24-27 min, 100% B; 27-28 min, 100-0% B; 28-35 min, 0% B. The

flow rate was 300  $\mu\text{L}/\text{min}$ ; injection volume was 2  $\mu\text{L}$ .  $\text{MS}_n$  analysis was performed on a Thermo Scientific LTQ -XL using electrospray ionisation (ESI) and detection in the positive ion mode, with a source voltage of 3.5 kV, and an ion transfer tube temperature of 350°C. The instrument was tuned to optimise the ionisation process and sensitivity using chlorogenic acid. A full-scan mass spectrum over a range of  $m/z$  values of 150–1500 was recorded. The control of the instrument and data processing were done using Xcalibur 2.07 (Thermo Scientific).

### 3.3 Results and discussion

#### 3.3.1 Hydraulic permeability and membrane cleaning

Figure 3.3.1-1 shows the hydraulic permeability of the UF membrane module measured with distilled water at 20°C, at a feed flow rate of 237 l/h in the range of TMP values of 0.2-1 bar.

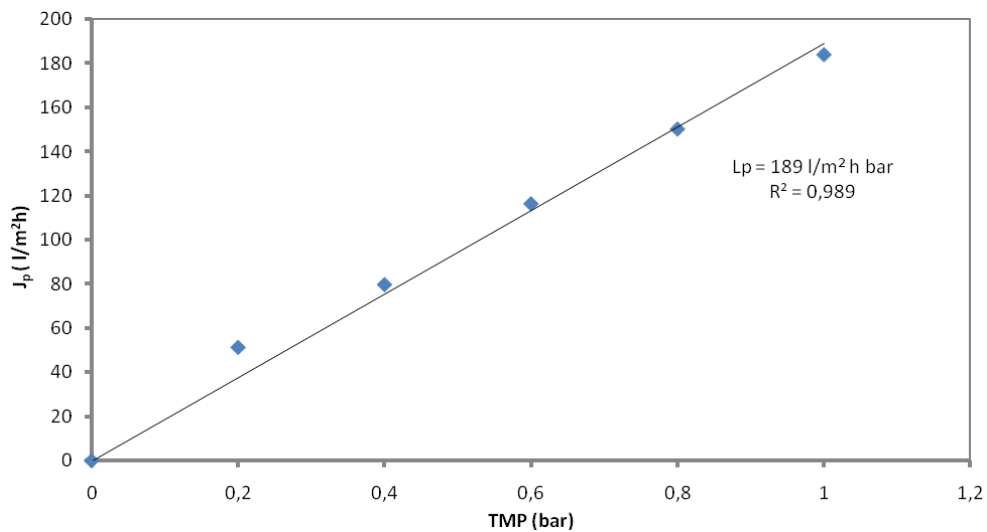

Figure 3.3.1-1 Characterisation of the UF membrane with distilled water (Operating temperature = 20±1°C).

The hydraulic permeability of the UF membrane before the juice treatment was 189  $\text{l}/\text{m}^2\text{hbar}$ . The measurement of the hydraulic permeability after cleaning procedures is depicted in Figure 3.3.1-2. As shown in the figure the enzymatic cleaning permitted to recover about 52% of the initial hydraulic permeability of the UF membrane. The following alkaline cleaning permitted to reach a 73% recovery of the original hydraulic

permeability. Consequently, a uncompleted recovery of the initial permeability of the UF membrane, attributed to an irreversible component of fouling phenomenon, was observed.

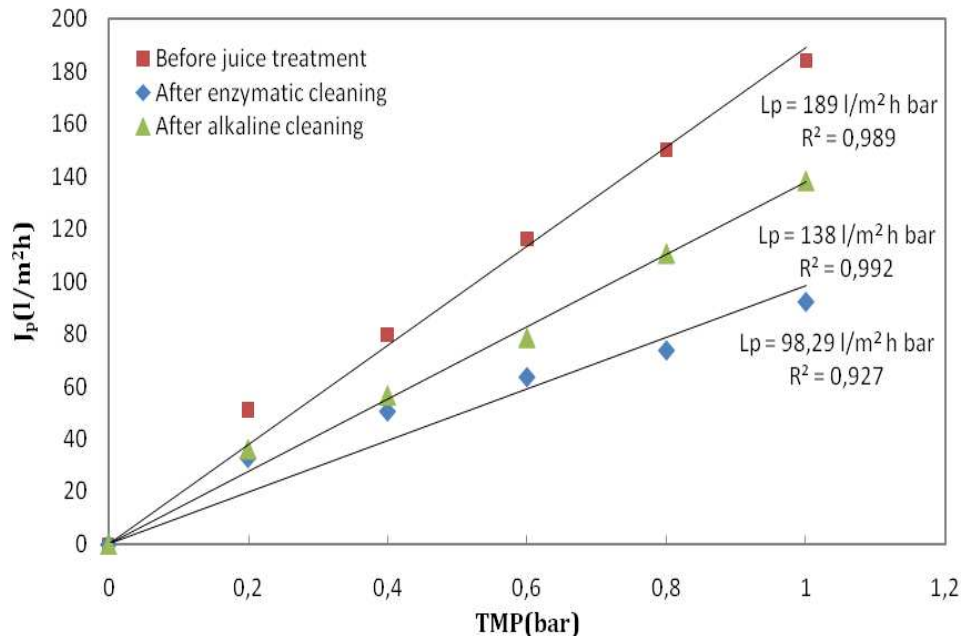

Figure 3.3.1-2 Characterisation of UF membrane before and after cleaning with different solutions (Operating temperature =  $20 \pm 1^\circ\text{C}$ ).

### 3.3.2 Clarification of blood orange juice by UF membrane

UF experiments carried out according to the batch concentration mode showed that the permeate flux decreased gradually with the operating times by increasing the VRF due to a concentration polarization and gel formation phenomena. The initial permeate flux of  $14.02 \text{ kg/m}^2\text{h}$  decreased to about  $2.7 \text{ kg/m}^2\text{h}$  (80%) corresponding to a final VRF value of 3.87 (Figure 3.3.2-1).

UF membranes typically retain microorganisms and large molecules as lipids, proteins and colloids, when small solutes such as aminoacids, vitamins, salts, sugars are allowed to flow through the membrane with water. Therefore the possibility of microbiological contamination in the permeate stream is minimised, avoiding any thermal treatments and, consequently, loss of volatile aroma compounds. Suspended solids are completely removed and the resulting clarified juice has lower viscosity and negligible turbidity [31, 32].

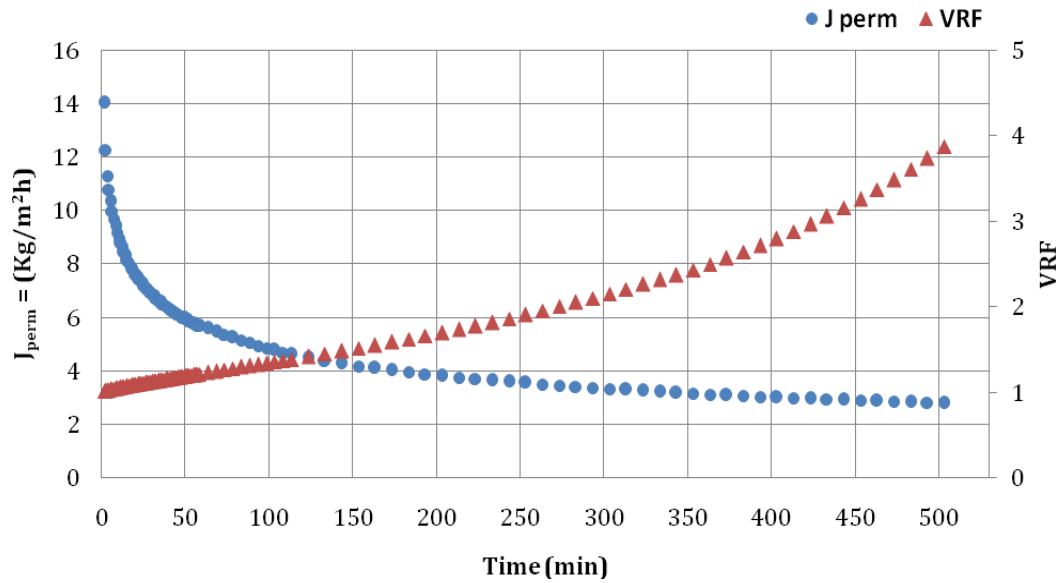

Figure 3.3.2-1 Time course of permeate flux and VRF in the ultrafiltration of blood orange juice (TMP = 0.8 bar;  $Q_f$  = 106 l/h;  $T = 20 \pm 1^\circ\text{C}$ )

### 3.3.3 Analytical results

In Table 3.3.3-1 the evaluation of TSS, suspended solids, conductivity and pH in samples obtained from the UF process are reported.

Table 3.3.3-1 Measurement of TSS, suspended solids, conductivity and pH in samples coming from the UF of blood orange juice

Sample	TSS (°Brix)	Suspended solids (%)	Conductivity ( $\mu\text{S}/\text{cm}$ )	pH
Feed	11	10	7410	3,5
Permeate	10.5	-	5550	3,5
Retentate	11	92	6530	3,5

Results show that suspended solids were completely removed from the depectinised juice. pH and soluble solids remained almost unchanged in the clarified juice. A decrease of the conductivity was observed in the permeate stream if compared with the original feed.

Table 3.3.3-2 shows the evaluation of TAA determined by the ABTS free radical decolourisation assay in samples coming from the UF process. A little decrease of the TAA (8.2%) was observed with respect to the fresh juice.

Table 3.3.3-2 Analyses of TAA in samples coming from the UF treatment

Sample	TSS (°Brix)	TAA (mM trolox)
Fresh juice	11.0	6.1±0.2
UF permeate	10.5	5.6±1.0
UF retentate	11.0	5.4±0.7

\* values referred to 11 °Brix

HPLC quantitative analyses of some antioxidant components were performed on samples before and after the UF treatment.

Figures 3.3.3-1 a and b shows phenolic compound profiles of depectinised juice (feed) and UF permeate, respectively. As can be seen, the profiles did not differ significantly among the samples before and after the treatments. A total of 11 phenolic compounds were identified in all samples by comparison with the retention time and ultra-violet-visible spectra of authentic standards, analyzed under identical conditions, and further confirmation using mass spectral data. The identified phenolic compounds, including hydroxycinnamic acids (5), hydroxybenzoic acids (2), flavanones (2) and flavan-3-ols (2), are reported in Table 4. Mean values of three replicates for each sample are given. SD% values were always lower than 3% for the three repetitions.

The quantitative data were performed by external calibration curves with standards. Two hydroxybenzoic acids, ellagic and *p*-hydroxybenzoic acids, were detected in all samples. The major hydroxybenzoic acid in all juice samples was ellagic acid.

The five hydroxycinnamic acids identified in the analysis were sinapic, *p*-coumaric, ferulic, caffeic and chlorogenic acids. Caffeic acid was the most dominant hydroxycinnamic acid in all samples. Chlorogenic acid was the second most abundant hydroxycinnamic acid followed by *p*-coumaric, sinapic and ferulic acids. By contrast, in another study, ferulic acid (37.7 mg/L) was found to be the main phenolic acid in blood orange juices from Sicily [33].

Two flavanones, naringin and hesperidin, were detected in all samples, and the most abundant compound was naringin.

The two flavan-3-ols identified in the analysis were catechin and epicatechin. Therefore, the profile of phenolic compound was dominated by ellagic acid, catechin and epicatechin. Anyhow ellagic acid was the major phenolic compound in all samples, while the least abundant compound was sinapic acid.

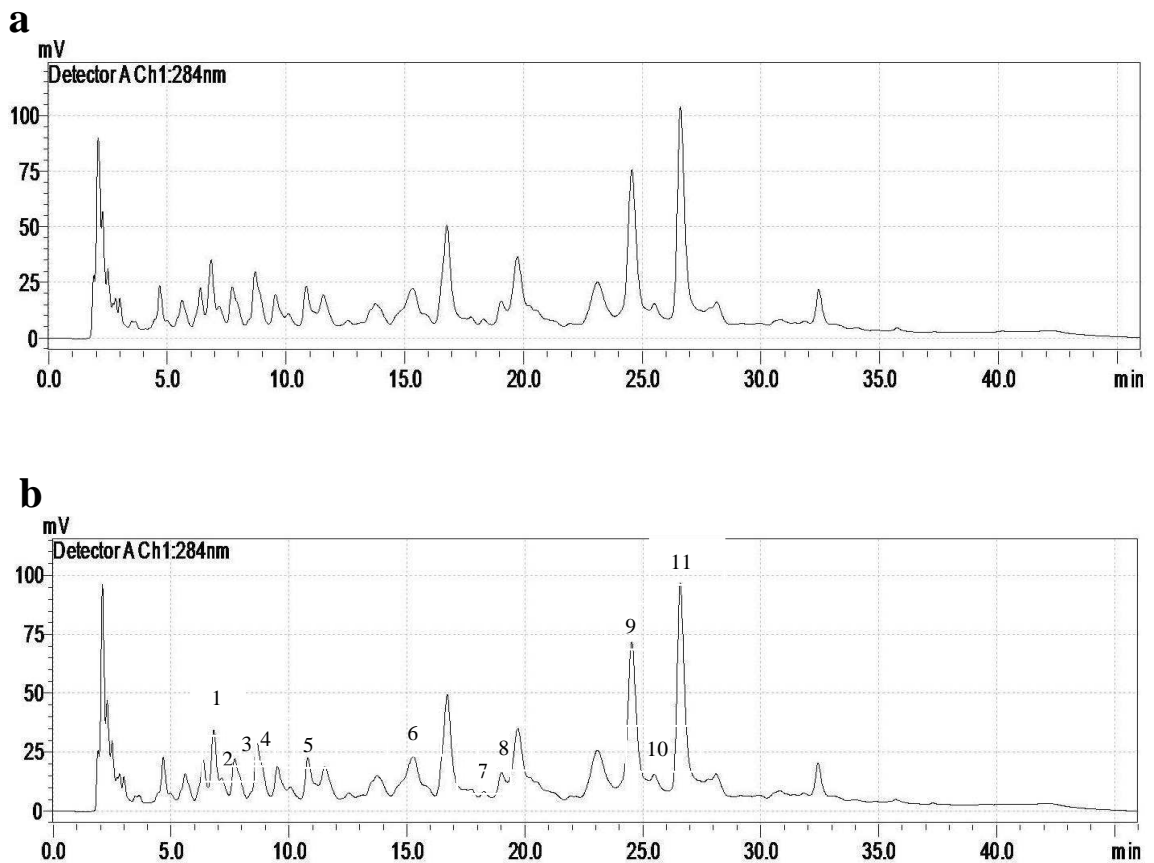

Figure 3.3.3-1 HPLC Chromatogram of (a) feed and (b) UF permeate and identified compounds

(1) catechin hydrate; (2) caffeic acid; (3) *p*-hydroxybenzoic acid; (4) chlorogenic acid; (5) epicatechin; (6) *p*-coumaric acid; (7) ferulic acid; (8) sinapic acid; (9) naringin; (10) hesperidin and (11) ellagic acid

The results reported in Table 3.3.3-4 show that phenolic compounds are recovered in the clarified juice obtained in the UF treatment (in which suspended solids are mainly removed from the depectinised juice) as also confirmed by the low rejection values (Table 3.3.3-5) of the UF membrane toward these compounds (between 0.4 and 6.9%).

Table 3.3.3-4 HPLC analyses of blood orange juice treated by UF (results are the means of three repetitions; values are expressed as mg/L)

Phenolic compounds	Feed	Permeate	Retentate
sinapic acid	8.25	7.77	8.87
p-coumaric acid	16.64	16.46	18.22
Naringin	101.18	97.03	102.40
hydroxybenzoic acid	50.21	47.66	53.41
hesperidin	19.73	18.93	23.89
ferulic acid	3.88	3.61	4.28
epicatechin	62.61	59.84	60.39
ellagic acid	99.98	94.63	89.13
Catechin	71.45	69.31	74.50
caffeic acid	48.60	46.09	51.73
chlorogenic acid	27.83	27.70	29.98

Table 3.3.3-5 Rejection of the UF membrane toward phenolic compounds

Phenolic compounds	Rejection (%)
sinapic acid	5.8
p-coumaric acid	1.1
Naringin	4.1
hydroxybenzoic acid	5.0
Hesperidin	4.0
ferulic acid	6.9
Epicatechin	4.4
ellagic acid	5.3
catechin hydrate	3.0
caffeic acid	5.1
chlorogenic acid	0.4

The HPLC coinjection analysis of the juices with authentic anthocyanins, commercially available, allowed to confirm the absence of cyanidin-3-O-glucoside, one of the major anthocyanins identified in blood orange juices [6,34] and of minor pigments, such as



cyanidin 3,5-diglucoside and cyanidin 3-rutinoside. So far, the samples were subjected to HPLC-ESI-MS<sup>n</sup> analyses to identify some other anthocyanins.

HPLC-ESI-MS<sup>n</sup> analyses revealed the presence of three pigments (1, 2 and 3) in all samples before and after UF (Figure 3.3.3-2).

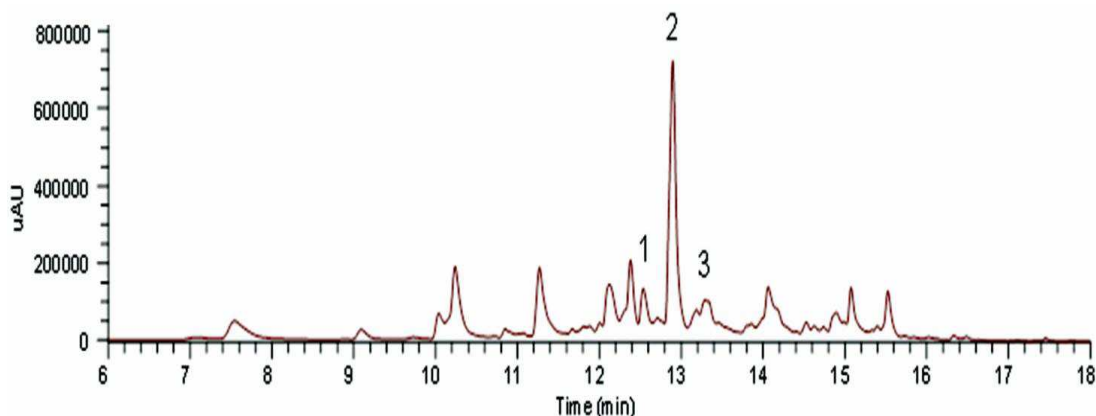

Figure 3.3.2-2 UHPLC–DAD profile of the UF permeate juice at 325 nm. (1) Delphinidin-3-*O*- $\beta$ -D-glucoside; (2) Delphinidin-3-(6''-malonyl glucoside); (3) Cyanidin 3-(6''-dioxalylglucoside)

The molecular masses  $[M]^+$  of the compounds 1 and 2 were determined to be at 465 and 551 mass units, respectively. Upon fragmentation, we observed for both compounds the detected ions with  $m/z$  303 that are indicative of the presence of a delphinidin aglycon. Fragment ion at  $m/z$  303  $[M-162]^+$  suggested for compound 1 the presence of one hexose. Compound 2 showed in addition, a fragment ion at  $m/z$  465  $[M-86]^+$ , the latter corresponding to the loss of one malonyl group: the presence of both fragment ions at  $m/z$  465 and at  $m/z$  303  $[M-86-162]^+$  suggested for compound 2 the presence of one malonyl group and one hexose. Thus, the pigments 1 and 2 were tentatively identified based on their mass spectrometric properties and comparison with literature data [35,36] as delphinidin 3-*O*- $\beta$ -D-glucoside and delphinidin 3-(6''-malonylglucoside), respectively. Compound 3 had a molecular mass  $[M]^+$  of 593 u: the detected ion with  $m/z$  287 following fragmentation of the pigment was indicative of the presence of cyaniding as aglycon. The fragmentation pattern showed two ions at  $m/z$  449  $[M-144]^+$  and  $m/z$  287  $[M-144-162]^+$ , the latter corresponding to the loss of one hexose. This compound was identified as cyanidin 3-(6''-dioxalylglucoside), on the basis of the comparison of its mass spectroscopic properties and literature data [6]. The mass

spectrometric properties and identities of anthocyanins 1-3 are summarized in Table 3.3.3-6.

*Table 3.3.3-6 Identity and mass spectrometric properties of anthocyanins from blood orange juice*

<b>Compound</b>	<b>[M+] (m/z)</b>	<b>MS/MS (m/z)</b>	<b>identified as</b>
<b>1</b>	465	303	delphinidin 3-O- $\beta$ -D-glucoside
<b>2</b>	551	303,465	delphinidin 3-(6''-malonylglucoside
<b>3</b>	593	287, 449	cyanidin 3-O- $\beta$ -D-(6''-dioxalylglucoside

**References**

1. Gattuso G, Barreca D, Gargiulli C, Leuzzi U, Caristi C. (2007) *Flavonoid composition of Citrus juices*. *Molecules*, 12 (8), 1641-73.
2. Wang, Y.-C., Chuang Y.-C. and Ku Y.-H. (2007) *Quantitation of bioactive compounds in citrus fruits cultivated in Taiwan*. *Food Chemistry*, 102 (4), 1163-1171.
3. Wang, Y.-C., Chuang Y.-C., and Hsu, H.-W. (2008) *The flavonoid, carotenoid and pectin content in peels of citrus cultivated in Taiwan*. *Food Chemistry*, 106 (1), 277-284.
4. Pennisi, L., *Trattato di Agrumicoltura*. (1985) Edagricole, Italy.
5. Maccarone, E., Maccarone, A., Perrini, G., and Rapisarda, P. ( 1983) *Anthocyanins of the Moro orange juice*. *Annali di Chimica*, 73, 533-86.
6. Maccarone, E., Rapisarda, P., Fanella, F., Arena, E., & Mondello, L. (1998) *Cyanidin-3-(6''-malonyl)- $\beta$ -glucoside. One of the major anthocyanins in blood orange juice*. *Italian Journal of Food Science*, 10, 367-372.
7. Rapisarda, P., Carollo, G., Fallico, B., Tomaselli, F. Maccarone, E. (1998) *Hydroxycinnamic Acids as Markers of Italian Blood Orange Juices*. *J Agric Food Chem*, 46 (2) 464-470.
8. Manthey, J.A., Grohmann, K. and Guthrie, N. (2001) *Biological properties of citrus flavonoids pertaining to cancer and inflammation*. *Curr Med Chem*, 8 (2) 135-53.
9. Kuljarachanan, T., S. Devahastin, and Chiewchan, N. ( 2009) *Evolution of antioxidant compounds in lime residues during drying*. *Food Chemistry*,. 113 (4) 944-949.
10. Rapisarda P, Tomaino A, Lo Cascio R, Bonina F, De Pasquale A, Saija A. (1999) *Antioxidant effectiveness as influenced by phenolic content of fresh orange juices*. *J Agric Food Chem*, 47 (11), 4718-23.
11. Manthey, J.A. and Guthrie, N. (2002) *Antiproliferative activities of citrus flavonoids against six human cancer cell lines*. *J Agric Food Chem*, 50 (21), 5837-43.
12. Miyagi Y, Om AS, Chee KM, Bennink MR. (2000) *Inhibition of azoxymethane-induced colon cancer by orange juice*. *Nutr Cancer*, 36 (2), 224-9.
13. Yang CS, Landau JM, Huang MT, Newmark HL. (2001) *Inhibition of carcinogenesis by dietary polyphenolic compounds*. *Annu Rev Nutr*, 21, 381-406.

14. Anagnostopoulou, M. A.; Kefalas, P.; Papageorgiou, V. P.; Assimopoulou, A. N.; Boskou, D. (2006) *Radical scavenging activity of various extracts and fractions of sweet orange peel (Citrus sinensis)*. Food Chemistry, 94 (1), 19-25.
15. Rapisarda, P. (1997) *Evoluzione e sviluppo nella produzione di succhi di arancia in Italia*. Rivista di Frutticoltura e Arbofloricoltura, 12, 23-25.
16. Andrés, S.C., Giannuzzi, L. and Zaritzky, N.E. (2001) *Mathematical Modeling of Microbial Growth in Packaged Refrigerated Orange Juice Treated with Chemical Preservatives*. Journal of Food Science, 66 (5) 724-728.
17. Pao, S. and Davis, C.L. (1999) *Enhancing microbiological safety of fresh orange juice by fruit immersion in hot water and chemical sanitizers*. J Food Prot, 62 (7), 756-60.
18. Polydera, A.C., Stoforos, N.G. and Taoukis, P.S. (2003) *Comparative shelf life study and vitamin C loss kinetics in pasteurised and high pressure processed reconstituted orange juice*. Journal of Food Engineering, 60 (1), 21-29.
19. Sizer, C.E., and Balasubramaniam, V. M. (1999) *New intervention processes for minimally processed juices*. Food Technology, 53, 64-67.
20. Yeom HW, Streaker CB, Zhang QH, Min DB. (2000) *Effects of pulsed electric fields on the quality of orange juice and comparison with heat pasteurization*. J Agric Food Chem, 48 (10) 4597-605.
21. Ayhan Z, Yeom HW, Zhang QH, Min DB. (2001) *Flavor, color, and vitamin C retention of pulsed electric field processed orange juice in different packaging materials*. J Agric Food Chem, 49 (2), 669-74.
22. Zerdin, K., Rooney, M.L. and Vermuë, J. (2003) *The vitamin C content of orange juice packed in an oxygen scavenger material*. Food Chemistry, 82 (3), 387-395.
23. Das, R., Bhattacharjee, C. and Ghosh, S. (2011) *Novel Approach to Recover Natural Antioxidants from Oil Seed Meal in Ultrafiltration-Nanofiltration-Based Technique*. Industrial & Engineering Chemistry Research, 50 (21), 12124-12133.
24. Jiao, B., Cassano, A. and Drioli, E. (2004) *Recent advances on membrane processes for the concentration of fruit juices: a review*. Journal of Food Engineering, 63 (3), 303-324.
25. Todisco, S., Tallarico, P., and Drioli, E. (1998) *Modelling and analyses of the effects of ultrafiltration on the quality of freshly squeezed orange juice*. Italian Food and Beverage Technology, 12, 3-8.

26. Beatriz M., José C., Cunha P., Miriam D., Hubinger. (2010) *Concentration of flavonoids and phenolic compounds in aqueous and ethanolic propolis extracts through nanofiltration*. Journal of Food Engineering, 96 (4), 533-539.
27. Tytkowski, B., Tsibranska, I., Kochanov, R., Peev, G., Giamberini, M. (2011) *Concentration of biologically active compounds extracted from Sideritis ssp. L. by nanofiltration*. Food and Bioproducts Processing, 89 (4) 307-314.
28. Cassano, A., Marchio, M. and Drioli, E. (2007) *Clarification of blood orange juice by ultrafiltration: analyses of operating parameters, membrane fouling and juice quality*. Desalination, 212 (1-3), 15-27.
29. Tasselli, F., Cassano, A. and Drioli, E. (2007) *Ultrafiltration of kiwifruit juice using modified poly(ether ether ketone) hollow fibre membranes*. Separation and Purification Technology, 57 (1), 94-102.
30. Rice-Evans, C. and Miller, N.J. (1994) *Total antioxidant status in plasma and body fluids*. Methods Enzymol, 234, 279-93.
31. Cassano, A., Donato, L., Conidi, C., Drioli, E. (2008) *Recovery of bioactive compounds in kiwifruit juice by ultrafiltration*. Innovative Food Science & Emerging Technologies, 9 (4), 556-562.
32. Cassano A. , Drioli E. , Galaverna G. , Marchelli R. , Di Silvestro G. , Cagnasso, P. (2003) *Clarification and concentration of citrus and carrot juices by integrated membrane processes*. Journal of Food Engineering, 57 (2), 153-163.
33. Rapisarda, P., Carollo, G., Fallico, B., Tomaselli, F., Maccarone, E., (1998) *Hydroxycinnamic acids as markers of Italian blood orange juices*. Journal of Agricultural and Food Chemistry 46, 464-470.
34. Mazza, G., Miniati, E., 1993. *Grapes*. In: Mazza, G., Miniati, E. (Eds.), *Anthocyanins in Fruits, Vegetables, and Grains*. CRC Press, Boca Raton, pp. 149-199.
35. Dugo, P., Mondello, L., Morabito, D., Dugo, G., (2003) *Characterization of the anthocyanin fraction of Sicilian blood orange juice by micro-HPLC-ESI/MS*. Journal of Agricultural and Food Chemistry, 51, 1173-1176.
36. Hillebrand, S., Schwarz, M., Winterhalter, P., (2004) *Characterization of Anthocyanins and Pyranoanthocyanins from Blood Orange [Citrus sinensis (L.) Osbeck] Juice*. Journal of Agricultural and Food Chemistry, 52, 7331-7338.

## CHAPTER IV

# OSMOTIC DISTILLATION OF CLARIFIED BLOOD ORANGE JUICE

### 4.1 Introduction

Osmotic distillation is a new membrane process also called “isothermal MD” that can be used to remove selectively water from aqueous solutions under atmospheric pressure and at room temperature, avoiding thermal degradation [1-4]. It involves the use of a microporous hydrophobic membrane to separate two circulating aqueous solutions at different solute concentrations: a dilute solution and an hypertonic salt solution. If the operating pressure is kept below the capillary penetration pressure of liquid into the pores, the membrane cannot be wetted by the solutions. The difference in solute concentrations, and consequently in water activity of both solutions, generates, at the vapour–liquid interface, a vapour pressure difference causing a vapour transfer from the dilute solution towards the stripping solution.

The water transport through the membrane can be summarized in three steps: (1) evaporation of water at the dilute vapour-liquid interface; (2) diffusional or convective vapour transport through the membrane pore; (3) condensation of water vapor at the membrane/brine interface [5-8].

As compared with RO and MD process, the OD process has the potential advantage which might overcome the drawbacks of RO and MD for concentrating fruit juice, because RO suffers from high osmotic pressure limitation, while in MD some loss of volatile components and heat degradation may still occur due to the heat requirement for the feed stream in order to maintain the water vapor pressure gradient. OD, on the other hand, does not suffer from any of the problems mentioned above when operated at room temperature.

The clarified blood orange juice coming from the UF process was submitted to the OD process by using a bench plant equipped with a hollow fibre membrane module. The

integrated membrane process was evaluated for its potentiality in preserving bioactive compounds of the juice in order to obtain formulations of interest for food or pharmaceutical applications.

The performance of the OD process was analyzed in terms of productivity and quality of concentrated samples through the identification and quantization of compounds of interest.

## **4.2 Material and methods**

### *4.2.1 Clarified blood orange juice*

The clarified juice was obtained according to the UF process described in the previous Chapter.

### *4.2.2 OD unit and procedures*

The permeate coming from the UF treatment was submitted to OD experiments by using a laboratory plant supplied by Hoechst-Celanese Corporation (Wiesbaden, Germany).

The plant, showed in Figure 4.2.2-1, is equipped with:

- two magnetic drive gear pumps for the circulation of both clarified juice and stripping solution in the shell side and in the lumen side (tube side) of the OD membrane module, respectively;
- four pressure gauges in order to register inlet and outlet pressures for both tube side and shell side streams;
- a digital balance (Gibertini Elettronica, Milan, Italy), placed under the juice tank, for measuring the weight of extracted water; it was used to calculate the evaporation flux ( $J_w$ ) expressed as  $\text{kg/m}^2\text{h}$ ;
- two flow-meters for measuring both brine and juice flow rate.

The plant was equipped with a Liqui-Cel<sup>®</sup> Extra-Flow 2.5x8", membrane contactor supplied by Hoechst-Celanese Corporation (Wiesbaden, Germany). The OD membrane module is constituted by hydrophobic hollow fibre membranes with an external diameter of 300  $\mu\text{m}$  and an internal diameter of 220  $\mu\text{m}$  (Figure 4.2.2-2).

Characteristics of the OD membrane module are summarized in Table 4.2.2-1.

The clarified juice, with an initial TSS concentration of 10.5 °Brix, was pumped through the shell side of the membrane module, with an average flow rate of 478 ml/min. A 60 w/w% calcium chloride dehydrate solution, used as stripping solution, was circulated in the tube side with an average flow rate of 573 ml/min in a counter current mode. It was chosen because it is not toxic and it is available at low cost. Both solutions were re-circulated back to their reservoirs, after passing through the contactor, at a temperature of  $25\pm 2^\circ\text{C}$ .

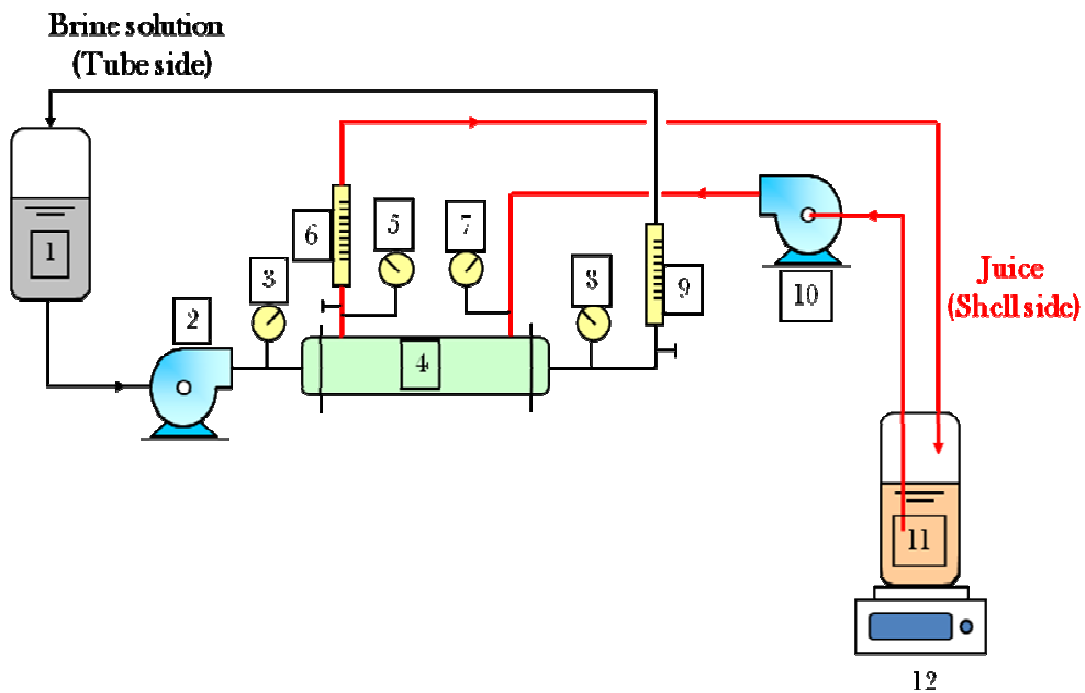

Figure 4.2.2 -1 Osmotic distillation bench plant scheme.

(1-extracting solution tank; 2 - brine pump; 3,5,7,8 - manometers; 4 - OD membrane module; 6,9 - flowmeters; 10 - feed pump; 11- feed tank; 12 - digital balance)

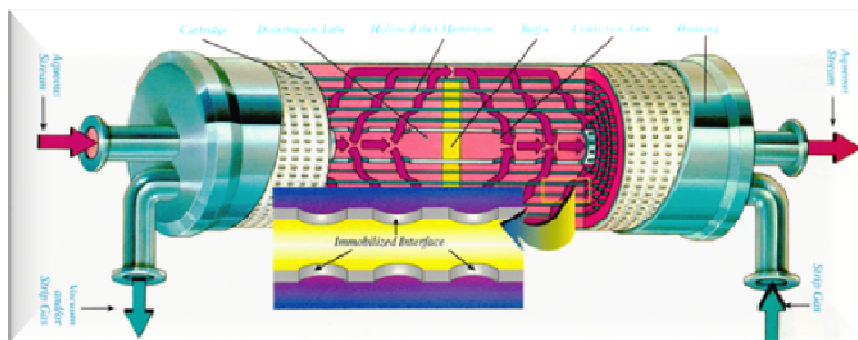

Figure 4.2.2-2 Osmotic distillation membrane module



Table 4.2.2-1 Data sheet of Liqui-Cel® Extra-Flow 2.5x8” membrane contactor

<b>Fiber Characteristics</b>	
Fiber type	Celgard® Microporous Polypropylene Hollow fiber
External diameter	300 µm
Internal diameter	220 µm
Length	0.16 m
Estimated number of fibres	9288
<b>Cartridge Operating Limits</b>	
Maximum Transmembrane Differential Pressure	4.2 kg/cm <sup>2</sup> (60 psi)
Maximum Operating Temperature Range	40 °C (104 °F)
<b>Cartridge Characteristics</b>	
Cartridge Dimensions (DxL)	8x28 cm (2.5x8 in)
Effective Surface Area	1.4 m <sup>2</sup> (15.2 ft <sup>2</sup> )
Effective Area/Volume	29.3 cm <sup>2</sup> /cm <sup>3</sup>
Fiber Potting Material	Polyethylene

The initial weight of the stripping solution was two times higher compared to that of the juice, in order to prevent a significant dilution with consequent decreasing of the driving force during the process. OD system was operated with a slightly higher pressure on the shell side of the module than the lumen side bar in order to avoid the leakage of the brine strip into the product. The average TMP was 0.23 bar.

The flow rate of the extracted water, at various points during the concentration process, was calculated by measuring the weight loss of the juice over the time by a digital balance. Flow rates normalised by the membrane surface area (1.4m<sup>2</sup>) gave the evaporation flux ( $J_w$ ) value.

OD experiments were performed in selected operating conditions up to reach the desired level of total soluble solids in the juice. After each trial, the pilot plant was cleaned first by rinsing the tube side and the shell side with distilled water. Then a KOH solution at 2 w/w% was circulated for 1 h at 40 °C. After a short rinsing with distilled water, a citric acid solution at 2 w/w % was circulated for 1 h at 40 °C. Finally the circuit was rinsed with distilled water.

### 4.2.3 Analytical determinations

OD samples were analysed in relation to total soluble solids, pH, total antioxidant activity and phenolic compounds according to the procedures reported in the previous Chapter.

## 4.3 Results and discussion

### 4.3.1 OD of clarified blood orange juice

Figure 4.3.1-1 shows the experimental results concerning the concentration of the ultrafiltered blood orange juice by OD within a closed loop from 10.5 to 61.4°Brix. Throughout the experimental run brine and juice temperature were maintained almost constant at  $28 \pm 2$  °C. At first, the brine concentration was 11.2 mol/L producing an evaporation flux of  $1.26 \text{ kg/m}^2\text{h}$ . During the process the evaporation flux decreased gradually up to reach a final value of  $0.41 \text{ kg/m}^2\text{h}$  corresponding to a final juice concentration of 61.4 °Brix.

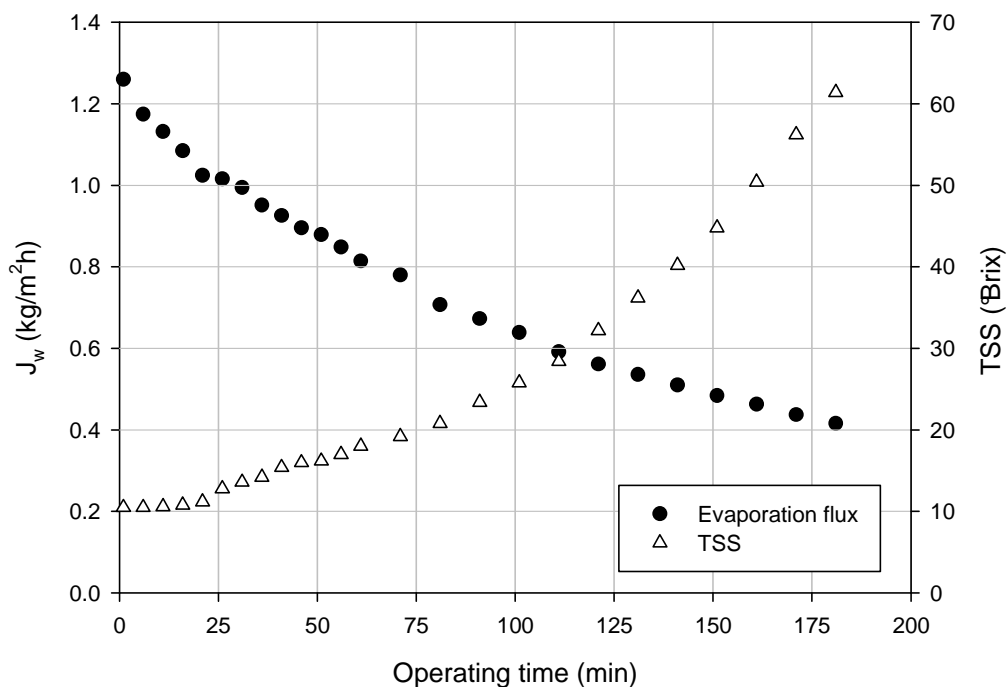

Figure 4.3.1-1 OD of clarified blood orange juice. Time course of evaporation flux and TSS concentration (operating conditions:  $TMP = 0.325$  bar,  $Q_j = 478$  ml/min;  $Q_b = 573$  ml/min;  $T = 25 \pm 2$  °C)

The decline in evaporation flux can be attributed to the decrease in brine concentration from 11.2 mol/L at 10.5°Brix, to 5.27 mol/L at 61.4°Brix (Figure 4.3.1-2). This result shows the strong influence of the brine concentration on the evaporation flux and, consequently, on the driving force of the OD process. The decrease in evaporation flux is associated to an exponential increase of the juice's viscosity which may raise resistance to mass transfer in the liquid phase and, consequently, may induce a lower driving force due to a polarization effect [1].

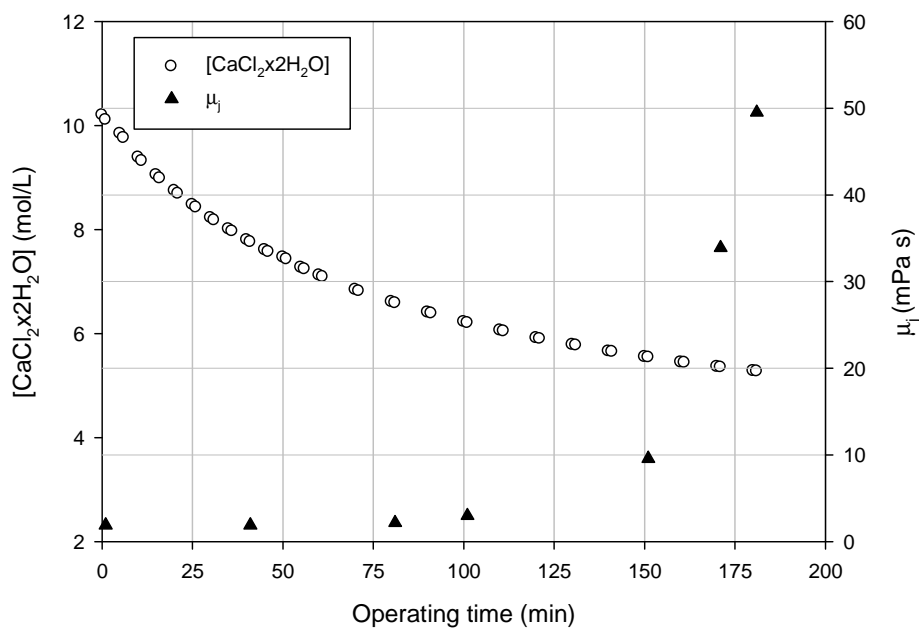

Figure 4.3.1-2 OD of clarified blood orange juice. Time course of calcium chloride concentration and juice viscosity (operating conditions:  $TMP = 0.325$  bar,  $Q_j = 478$  ml/min;  $Q_b = 573$  ml/min;  $T = 25 \pm 2^\circ\text{C}$ )

#### 4.3.2 Analytical measurements

TAA measurements were performed on the initial fresh juice, on the UF permeate and retentate fractions and on the concentrate juice produced by OD. The antioxidant activity was measured after rediluting the concentrated juices to the same TSS concentration of the fresh juice (10.5°Brix), in order to allow the direct comparison between different samples. Results are reported in Table 4.3.2-1 (the final concentration in TSS achieved by the various treatments is also indicated).

The fresh juice showed a total antioxidant activity slightly higher than that of the juices after filtration and concentration steps ( $6.1 \pm 0.2$  mM Trolox). In the permeate coming from the UF process a little decrease of the TAA (8.2%) was observed with respect to the fresh juice. The data reported in the Table 4.3.2-1 showed that the concentration treatment by OD did not induce significant changes in TAA ( $5.3 \pm 0.6$  mM Trolox) with respect to that of UF permeate. Similar results were obtained by several Authors in the concentration of different clarified fruit juices (pomegranate, kiwi, orange, bergamot, cactus pear, apple, grape) and vegetable extracts by using OD [9-13] confirming the particular mildness of the treatment.

Table 4.3.2-1 Results of TAA in samples coming from UF/OD treatments

Sample	TSS (°Brix)	TAA (mM trolox)
Fresh juice	11.0	$6.1 \pm 0.2$
UF permeate	10.5	$5.6 \pm 1.0$
UF retentate	11.0	$5.4 \pm 0.7$
OD retentate	61.4	$5.3 \pm 0.6^*$

\* values referred to 10.5 °Brix

HPLC quantitative analyses of some antioxidant components were performed on samples before and after each technological treatment.

Figures 4.3.2-1 a-c show phenolic compound profiles of depectinised juice (feed), UF permeate and retentate OD, respectively. As can be seen, the profiles did not differ significantly among the samples before and after the treatments.

A total of 11 phenolic compounds were identified in all samples by comparison with the retention time and ultra-violet-visible spectra of authentic standards, analyzed under identical conditions, and further confirmation using mass spectral data. The identified phenolic compounds, including hydroxycinnamic acids (5), hydroxybenzoic acids (2), flavanones (2) and flavan-3-ols (2), were reported in Table 4.3.2-2 Mean values of three replicates for each sample are given. SD% values were always lower than 3% for the three repetitions.

(a)

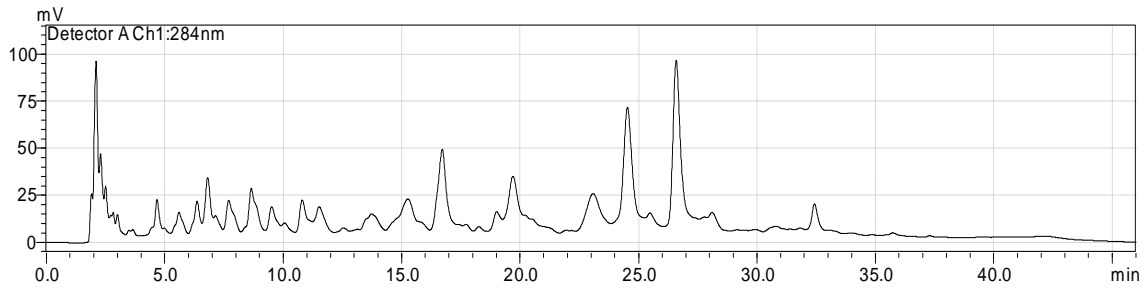

(b)

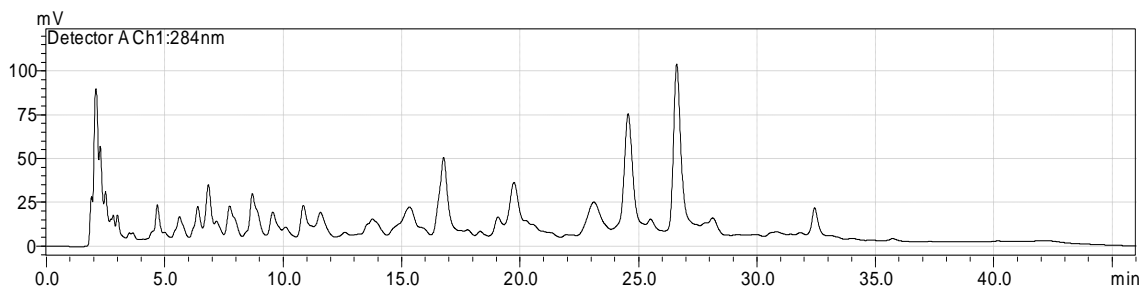

(c)

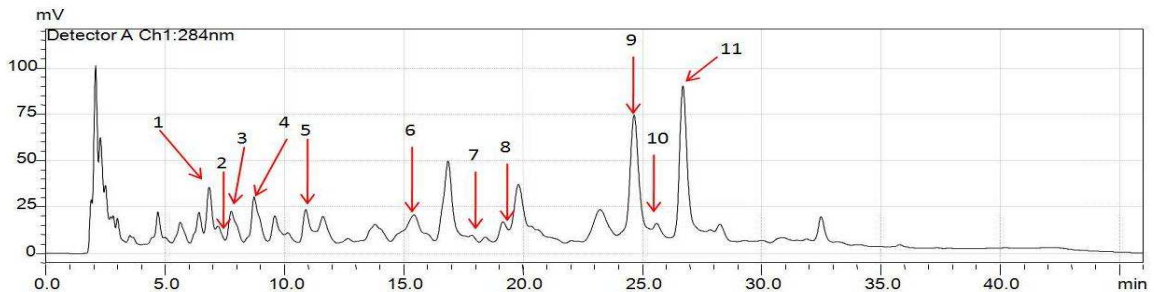

Figure 4.3.2-1 - HPLC Chromatogram of (a) feed, (b) UF permeate and (c) OD concentrated juice and identified compounds

(1) catechin hydrate; (2) caffeic acid; (3) *p*-hydroxybenzoic acid; (4) chlorogenic acid; (5) epicatechin; (6) *p*-coumaric acid; (7) ferulic acid; (8) sinapic acid; (9) naringin; (10) hesperidin and (11) ellagic acid

The results reported in Table 4.3.2-2 show that phenolic compounds are recovered in the clarified juice obtained in the UF treatment (in which suspended solids are mainly removed from the depectinised juice) as also confirmed by the low rejection values of the UF membrane toward these compounds (data shown in Chapter 3).

Phenolic compounds were well preserved in the retentate sample of the OD process (having a content of total soluble solids of 61.4°Brix) as demonstrated by the constant

value of the ratio between the concentration of phenolic compounds in OD retentate and the concentration of these compounds in the UF permeate stream (in the range 5.54-6.39).

Table 4.3.2-2 HPLC analyses of blood orange juices (Results are the means of three repetitions. Values are expressed as mg/L)

	UF			OD
	Feed	Permeate	Retentate	Retentate
sinapic acid	8.25	7.77	8.87	8.30
<i>p</i> -coumaric acid	16.64	16.46	18.22	15.78
naringin	101.18	97.03	102.40	101.63
<i>p</i> -hydroxybenzoic acid	50.21	47.66	53.41	52.049
hesperidin	19.73	18.93	23.89	19.89
ferulic acid	3.88	3.61	4.28	3.72
epicatechin	62.61	59.84	60.39	62.76
ellagic acid	99.98	94.63	89.13	102.53
catechin	71.45	69.31	74.50	73.08
caffeic acid	48.60	46.09	51.73	50.38
chlorogenic acid	27.83	27.70	29.98	29.54

The HPLC coinjection analysis of the juices with authentic anthocyanins, commercially available, allowed to confirm the absence of cyanidin-3-O-glucoside, one of the major anthocyanins identified in blood orange juices [14,15] and of minor pigments, such as cyanidin 3,5-diglucoside and cyanidin 3-rutinoside. So far, the samples were subjected to HPLC-ESI-MS<sup>n</sup> analyses to identify some other anthocyanins.

HPLC-ESI-MS<sup>n</sup> analyses revealed the presence of three pigments (1, 2 and 3) in all samples before and after membrane operations (Figure 4.3.2-2).

The molecular masses [M]<sup>+</sup> of the compounds 1 and 2 were determined to be at 465 and 551 mass units, respectively. Upon fragmentation, we observed for both compounds the detected ions with *m/z* 303 that are indicative of the presence of a delphinidin aglycon. Fragment ion at *m/z* 303 [M-162]<sup>+</sup> suggested for compound 1 the presence of one hexose. Compound 2 showed in addition, a fragment ion at *m/z* 465 [M - 86]<sup>+</sup>, the latter corresponding to the loss of one malonyl group: the presence of both fragment ions at

$m/z$  465 and at  $m/z$  303  $[M - 86 - 162]^+$  suggested for compound 2 the presence of one malonyl group and one hexose. Thus, the pigments 1 and 2 were tentatively identified based on their mass spectrometric properties and comparison with literature data [16,17] as delphinidin 3- $O$ - $\beta$ -D-glucoside and delphinidin 3-(6''-malonylglucoside), respectively. Compound 3 had a molecular mass  $[M]^+$  of 593 u: the detected ion with  $m/z$  287 following fragmentation of the pigment was indicative of the presence of cyaniding as aglycon. The fragmentation pattern showed two ions at  $m/z$  449  $[M - 144]^+$  and  $m/z$  287  $[M - 144 - 162]^+$ , the latter corresponding to the loss of one hexose. This compound was identified as cyanidin 3-(6''-dioxalylglucoside), on the basis of the comparison of its mass spectroscopic properties and literature data [15].

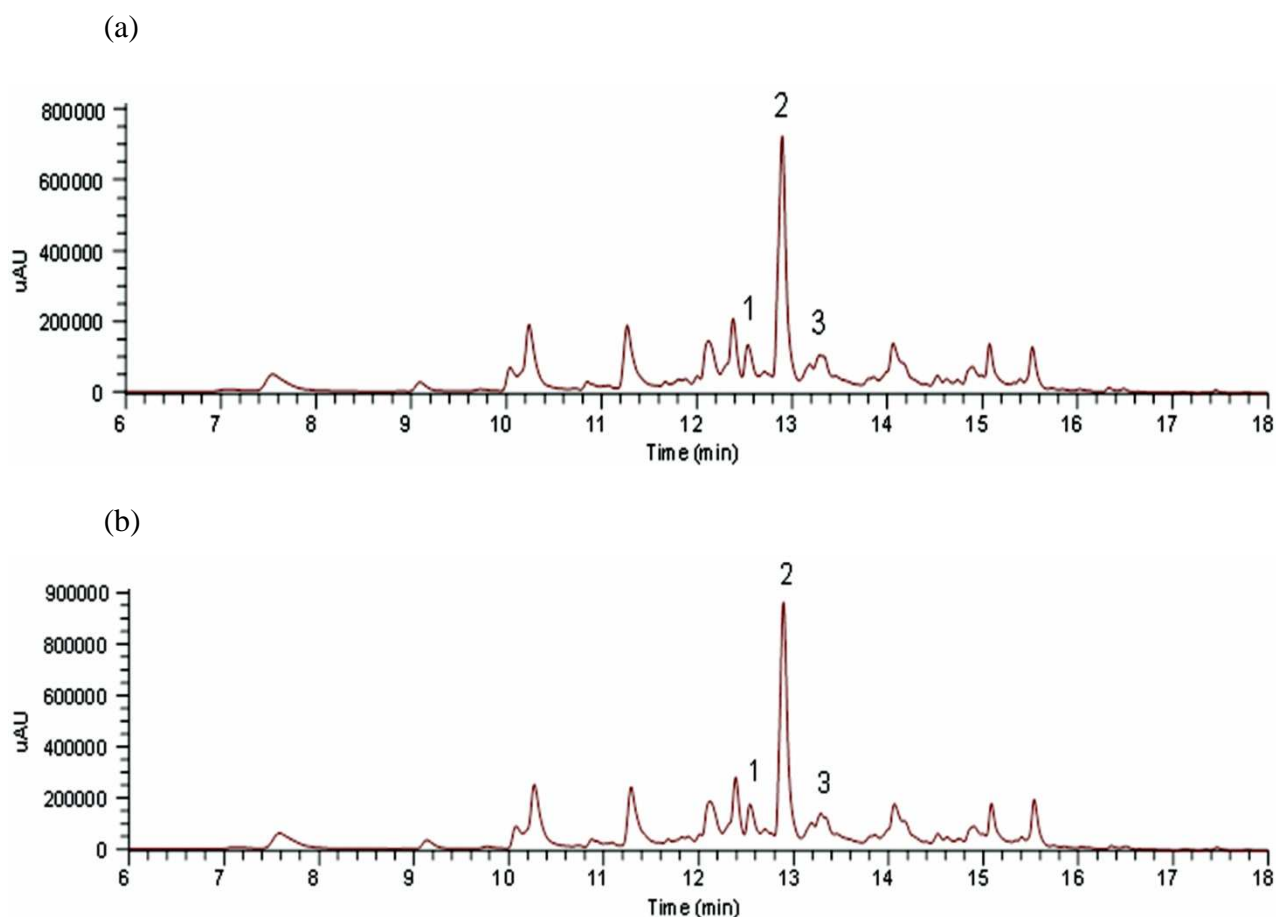

Figure 4.3.2-2 - UHPLC profile of the (a) UF permeate and (b) OD concentrated juice at 325 nm

(1) Delphinidin-3- $O$ - $\beta$ -D-glucoside; (2) Delphinidin-3-(6''-malonyl glucoside); (3) Cyanidin 3-(6''-dioxalylglucoside)

As revealed for other phenolic compounds, the UHPLC profile of identified anthocyanins in the UF permeate was very similar to that observed for the concentrated juice indicating a good preservation of these compounds in the OD process.

These results corroborate previous findings on the athermal concentration of roselle extract [13] in which losses of anthocyanins in concentrated samples were of about 3% in comparison with the initial extract. On the contrary, high temperature treatments tend to significantly decrease the stability of anthocyanins during storage [18].

The investigated process, based on the integration of two membrane technologies, UF and OD, presented good potential for recovering and concentrating most part of antioxidant compounds of blood orange juices.

The UF process permitted to remove suspended solids from the depectinised orange juice producing a clear juice in which the total antioxidant activity was well preserved in comparison to the fresh juice.

The concentration of the UF permeate by OD produced a concentrated juice with a total soluble solids content of 61.4°Brix. A direct comparison of results between clarified and concentrated juice showed no significant differences in their content of phenolic compounds. Consequently a good preservation of antioxidant compounds was guaranteed by the integrated UF-OD process in which thermal and mechanical stress of the juice is strongly reduced in comparison with conventional methodologies.



**References**

1. Courel, M., Dornier, M., Herry, J. M., Rios, G. M., Reynes, M. (2000) *Effect of operating conditions on water transport during the concentration of sucrose solutions by osmotic distillation*. Journal of Membrane Science, 170 (2), 281–289.
2. Hogan, P.A., Canning, R. P., Peterson, P. A., Johnson, R. A., Michaels, A. S. (1998) *A new option: osmotic distillation*. Chemical Engineering Progress, 49-61.
3. Nagaraj, N., Patil, B.S., Biradar, P.M. (2006) *Osmotic membrane distillation – A brief review*. International Journal of Food Engineering, 2, 1-22.
4. Kunz, W., Benhabiles, A., Ben-Aïm, R. (1996) *Osmotic evaporation through macroporous hydrophobic membranes: a survey of current research and applications*. Journal of Membrane Science, 121(1), 25-36.
5. Lefebvre, M.S.M. (1992) *Osmotic distillation process and semipermeable barriers therefore*. US Patent 5,098,566, 24 March.
6. Gostoli, C. (1999) *Thermal effects in osmotic distillation*. Journal of Membrane Science, 163 (1), 75–91.
7. Mengual, J. I., Zarate, J. M., Pena, L., Velazquez, A. (1993) *Osmotic distillation through porous hydrophobic membranes*. Journal of Membrane Science, 82 (1–2), 129–140.
8. Sheng, J., Johnson, R. A., Lefebvre, M. S. (1991) *Mass and heat transfer mechanism in the osmotic distillation process*. Desalination, 80 (2–3), 113–121.
9. Galaverna, G., Di Silvestro, G., Cassano, A., Sforza, S., Dossena, A., Drioli, E., Marchelli, R. (2008) *A new integrated membrane process for the production of concentrated blood orange juice: Effect on bioactive compounds and antioxidant activity*. Food Chemistry, 106, 1021-1030.
10. Cassano, A., Drioli, E., Galaverna, G., Marchelli, R., Di Silvestro, G., Cagnasso, P. (2003) *Clarification and concentration of citrus and carrot juices by integrated membrane processes*. Journal of Food Engineering, 57, 153-163.
11. Cassano, A., Drioli, E. (2007) *Concentration of clarified kiwifruit juice by osmotic distillation*. Journal of Food Engineering, 79, 1397-1404.
12. Cassano, A., Conidi, C., Timpone, R., D’Avella, M., Drioli, E. (2007) *A membrane-based process for the clarification and the concentration of the cactus pear juice*. Journal of Food Engineering, 80, 914-921.
13. Cissé, M., Vaillant, F., Bouquet, S., Pallet, D., Lutin, F., Reynes, M., Dornier, M. (2011) *Athermal concentration by osmotic evaporation of roselle extract, apple and grape juices and impact on quality*. Innovative Food Science and Emerging technologies, 12, 352-360.

14. Mazza, G., Miniati, E., 1993. *Grapes*. In: Mazza, G., Miniati, E. (Eds), *Anthocyanins in Fruits, Vegetables, and Grains*. CRC Press, Boca Raton, 149-199.
15. Maccarone, E., Rapisarda, P., Fanella, F., Arena, E., Mondello, L. (1998) *Cyanidin-3-(6''-malonyl)- $\beta$ -glucoside*. *One of the major anthocyanins in blood orange juice*. Italian Journal of Food Science 10, 367-372.
16. Dugo, P., Mondello, L., Morabito, D., Dugo, G. (2003) *Characterization of the anthocyanin fraction of Sicilian blood orange juice by micro-HPLC-ESI/MS*. Journal of Agricultural and Food Chemistry 51, 1173-1176.
17. Hillebrand, S., Schwarz, M., Winterhalter, P. (2004) *Characterization of Anthocyanins and Pyranoanthocyanins from Blood Orange [Citrus sinensis (L.) Osbeck] Juice*. Journal of Agricultural and Food Chemistry, 52, 7331-7338.
18. Cissé, M., Vaillant, F., Kane, A., Ndiaye, O., Dornier, M. (2012) *Impact of the extraction procedure on the kinetics of anthocyanin and colour degradation of roselle extracts during storage*. Journal of the Science of Food and Agriculture, 92, 1214-1221.

## CHAPTER V

# ANALYSIS OF ANTI-INFLAMMATORY ACTIVITY OF BLOOD ORANGE JUICE TREATED BY MEMBRANE OPERATIONS

### 5.1 Introduction

Fresh blood orange juice is successful on the market because of its taste and nutritional value [1]. Blood oranges have a pleasant taste and are distinguished among the sweet oranges by the rich burgundy color of the flesh and sometimes of the peel.

Citrus contains a host of active phytochemicals that contribute to health. In fact, there are more than 170 phytochemicals in an orange. It is commonly accepted that consumption of certain foods can prevent cancer [2]. Citrus products have received much attention in recent years, because of potential therapeutic benefits associated with high levels of flavonoids, having anti-allergenic, antioxidant, anticancer, and anti-inflammatory properties [3]. Flavonoids have a wide range of biological effects, such as inhibition of key enzymes in mitochondrial respiration, protection against coronary heart disease, and anti-spasmodic, anti-inflammatory, antioxidative, vascular, estrogenic, cytotoxic anti-tumor, and antimicrobial activities [4]. Citrus species typically contain various flavonoids such as flavanones, flavones and their glycosides (i.e., hesperidin, neohesperidin, naringin, narirutin, diosmin) and polymethoxyflavones (i.e., tangeritin, nobiletin) [5]. It is known that hesperidin improves vascular integrity and decreases capillary permeability, such that it is given as a supplement to patients with fragile blood vessels [6]. Furthermore, in association with naringin, hesperidin might reduce cholesterol levels [3].

The red color of blood oranges is primarily associated with anthocyanin pigments [7] not usually found in citrus but common in berry fruits, represented mainly by cyanidin-3-glucoside and cyanidin-3-(6''-malonyl)-glycoside [8].

It is known that the thermal treatment by pasteurization and/or thermal concentration produces modifications of some components with consequent degradation of taste and chemical characteristics. Several studies have shown that citrus processing not only affects the chemical and sensorial properties of the juice but also their functional properties [9]. In particular, concentration reduces the storage volumes (so reducing transport and storage costs) and facilitates the preservation; on the other hand, when the concentration is carried out by evaporation, most of the aroma compounds contained in the raw juice are lost and the aroma profile undergoes an irreversible change with a consequent remarkable qualitative decline [10]. In order to find alternative processes to the thermal treatment efforts have been made to increase the shelf-life and to retain as much as possible the peculiarity of fresh fruit, as well as color, aroma, nutritional value and structural characteristics.

Today membrane processes are very efficient systems to preserve the nutritional and organoleptic properties of the fresh product owing to the possibility of operating at room temperature with low energy consumption (see the previous chapters). The antioxidant activity of blood orange juice is mainly related to its total flavonoid content, including the anthocyanins and also hesperidin and narirutin. Oranges with higher levels of these compounds were demonstrated to be better antioxidants [11]. Recent studies emphasize that recurrent or chronic inflammations associated with an oxidative stress have been implicated in various diseases such as cancer, diabetes, autoimmune diseases, etc. The development of strategies for reducing inflammation and oxidation status could lead to effective treatments for these diseases. In this way, some natural products containing biological active molecules could participate to the prevention or the treatment of some of these diseases [12].

Inflammation plays an important role in various diseases, such as rheumatoid arthritis, atherosclerosis, obesity, asthma, hypertension and insulin resistance which all show a high prevalence globally. In obesity, lipid storage in adipocytes is increased, which triggers the release of adipokines [13].

Recent studies have shown that among the adipokines up-regulated in lipid-loaded adipocytes, monocyte chemoattractant protein-1 (MCP-1) plays a crucial role in inducing macrophage infiltration into adipose tissues, leading to the amplification of the adipose tissue inflammatory response [14].

During an inflammatory response, mediators, such as pro-inflammatory cytokines, including interleukin1 (IL-1), tumour necrosis factor (TNF), interferon (INF)-c, interleukin 6 (IL-6), interleukin 12 (IL-12), interleukin 18 (IL-18) and the granulocyte–macrophage colony-stimulating factor, are released, moreover inducible nitric oxide synthase (iNOS) stimulates the production of large amounts of pro-inflammatory mediators. Tumor necrosis factor-alpha (TNF- $\alpha$ ), one of the best characterized cytokines, was originally discovered in the mouse serum during endotoxemia and recognized for its anti-tumor activity [15]. At present it is well established that apart from the microglial cells, TNF- $\alpha$  can also be synthesized and released in the brain by astrocytes and some populations of neurons. The uncontrolled NO produced by the inducible NO synthase (iNOS) gives rise to reactive nitrogen species, which induce biomolecular and cellular damage. This cytokine is implicated in inflammatory disorders and carcinogenesis [16]. Nitric oxide is a gas generally known by its chemical formula NO, or NO<sup>\*</sup>. The dot denotes an unpaired electron, which is the definition of a free radical; possessing this, NO is highly reactive and quite -different from the anaesthetic agent nitrous oxide (N<sub>2</sub>O), which is extremely stable. In 1987, it was shown that NO was the long sought endothelium derived relaxing factor (EDRF) [17]. This was a crucial discovery for cardiovascular biology, and it soon became evident that NO was produced by many cell types and performed diverse functions, including inhibition of platelet aggregation and mediation of the cytotoxic action of activated macrophages, and had a role in central and peripheral neurotransmission. NO has many actions relevant to rheumatic diseases, being implicated in inflammation and immunoregulation, hypoxicreperfusion injury and vasculitis, cartilage and bone physiology, peptic ulceration, and pain mechanisms [18]. Although inflammation is primarily a protective response (against micro-organisms, toxins or allergens, for example), inflammation that is chronic and uncontrolled becomes detrimental to tissues [19].

In this Chapter results related to the evaluation of anti-inflammatory activity *in vitro* of samples coming from the treatment of blood orange juice by integrated UF/OD process are analyzed and discussed. In particular, clarified and concentrated blood orange juice samples were analyzed for their anti-inflammatory activity *in vitro* by testing their

inhibitory activity on the production of nitric oxide (NO), TNF- $\alpha$ , MCP-1 and IL-6 in lipopolisaccharide (LPS)-stimulated mouse macrophages RAW 264.7.

## **5.2 Material and methods**

### *5.2.1 Chemicals and standards*

Xanthohumol and LPS were purchased from Sigma-Aldrich (Schnelldorf, Germany); Water for the mobile phase was purified with a Milli-Q system (Millipore, Bedford, MA.); Dulbecco's modified Eagle's medium (DMEM), Roswell Park Memorial Institute 1640 (RPMI-1640); fetal bovine serum (FBS), streptomycin and penicillin were acquired from Lonza (Verviers SPRL, Belgium); Nitric Oxide standard and Griess reagents were purchased from Cayman Chemical (Ann Arbor, MI, USA); ELISA was performed using R&D Systems kits (Abingdon, UK); Bicinchoninic acid (BCA) protein assay kit was acquired from Pierce (Rockford, IL, USA); XTT Cell Proliferation Kit II was purchased from Roche Applied Science (Almere, The Netherlands); LDH Cytotoxicity Detection kit was purchased from Roche Applied Science.

### *5.2.2 Blood orange juice samples*

Samples of clarified juice (UF permeate) and concentrated juice (OD retentate) were produced according procedures discussed in previous Chapters 3 and 4.

### *5.2.3 Evaluation of anti-inflammatory activity in cell culture*

Samples coming from different membrane processes had a different concentration of total soluble solids and high acidity. All samples were diluted at the same TSS concentration (10.5 °Brix) by using Dulbecco's Modified Eagle's Medium.

The RAW 264.7 macrophage cell line, obtained from American Type Culture Collection (Teddington, U.K.), was cultured in Dulbecco's Modified Eagle's Medium with 10% (v/v) fetal bovine serum, 100U/mL penicillin, and 100  $\mu$ g/mL streptomycin at 37°C in a 5%(v/v) CO<sub>2</sub> humidified air atmosphere. RAW264.7 cells were seeded in a 96-well culture plate at a density of 25 x 10<sup>3</sup> per well and incubated overnight. After removal of the supernatant, adherent cells were treated with 1  $\mu$ g/mL LPS in combination with diluted solution of xanthohumol. Pure xanthohumol was dissolved in ethanol 100% (final concentration used for the cells treatment never exceeded 0.1% v/v

of ethanol). Following 4 h of incubation, the medium was collected for enzyme-linked immunosorbent assay (ELISA).

After the supernatant was removed, fresh medium was added, and cells were incubated for 48 hours.

#### *5.2.3.1 Measurement of nitric oxide production*

After incubating for 48 h, NO accumulated in the culture medium was measured as an indicator of NO production using the Griess method [21].

UF and OD samples were both incubated with and without LPS. The concentration of NO was quantified from a standard curve. Data were expressed as percentage of the positive LPS-treated control (set at 100%). However, because of nitric oxide detection limits, LPS (1 µg/ml) was used to measure NO production. Incubation times were selected based on the specific properties of different inflammatory mediators. 100 µl of the cell culture medium were mixed with 50 µl of Griess reagent 1 and 50 µl of Griess reagent 2; then the plate of cell culture was incubated at room temperature for few min, removing air bubbles before absorbance measurements. Absorbance was measured at 540nm using an ELISA plate reader (Multiskan Ascent).

#### *5.2.3.2 Measurement of TNF- $\alpha$ , IL-6 and MCP-1 production*

TNF- $\alpha$ , IL-6 and MCP-1 concentrations were determined by ELISA. ELISA was performed according to the manufacturer's protocol using R&D Systems kits (Abingdon, U.K.) for mouse TNF- $\alpha$ , IL-6 and MCP-1. Controls contained medium with equivalent amounts of solvent as compared to the treatments. These were incubated both with and without LPS. The concentrations of TNF- $\alpha$ , IL-6 and MCP-1 were quantified from a standard curve. Data were expressed as percentage of the positive LPS-treated control (set at 100%).

#### *5.2.3.3 Viability and cytotoxicity assays*

The determination of cellular viability was carried out by using an XTT Cell Proliferation Kit II (Roche Applied Science, Almere, The Netherlands). Briefly, RAW264.7 cells were incubated for 24 h with the samples and 1µg/mL of LPS. After incubation, the supernatant was carefully removed, and 100 µL of fresh medium,

together with sodium 3'-[1-(phenylaminocarbonyl)-3,4-tetrazolium]bis(4-methoxy-6-nitro)benzenesulfonic acid hydrate (XTT) (final concentration = 0.45 mM) and N-methyl-dibenzopyrazine methyl sulfate (1.25 mM), were added. After 4 h of incubation at 37 °C, the amount of formazan accumulated in the growth medium was measured at 450 nm using an ELISA plate reader (Multiskan Ascent, Thermo LabSystem, Breda, The Netherlands). The conditions were considered to be toxic if the cell's ability to metabolize XTT to formazan was lowered by >20% in comparison to that of the untreated control. Cytotoxicity of the samples was evaluated through an LDH Cytotoxicity Detection Kit (Roche Applied Science). RAW 264.7 macrophages were treated for 24 h with the samples in the presence of 1 µg /mL of LPS. After the supernatant had been carefully removed, a mixture of the catalyst (diaphorase/NAD<sup>+</sup> mixture, 250 µL) and the dye solution (iodotetrazolium chloride and sodium lactate, 11.25 mL) was added to adherent cells (100 µL/well). After 30 min of incubation at 25 °C, the absorbance was measured at 490 nm using an ELISA plate reader (Multiskan Ascent) [22].

#### 5.2.4 Statistical Analysis

Each experiment was performed independently at least three times in triplicate. Data are expressed as means ( $\pm$ SD) of the normalized values.

### 5.3 Results and discussion

#### 5.3.1 Effect of UF and OD samples on NO released in LPS-stimulated RAW 264.7 mouse macrophages

At first the effect of samples coming from UF and OD processes on RAW 264.7 cells stimulated with 1 µg/mL of LPS was investigated. Macrophages were treated with different dilutions (1:10000, 1:25000, 1:50000, 1:100000 and 1:1000000) of blood orange juice in DMEM. NO is known to be a late inflammatory marker and can be determined in LPS-stimulated macrophages from 24 h onwards, with levels still increasing up to 48 h and possibly later. In our case the effect on NO release was determined after 24 h of incubation and the concentrations of NO were measured by Griess Method. As shown in Figure 5.3.1-1, blood orange juice appeared to be an effective inhibitor of NO release. A dilution 1:1000000 of the UF permeate caused a



significant inhibition by 31.7%. The dilution 1:100000 gave a more pronounced effect (40.2%). The highest effect of inhibition was detected with the dilution 1:50000 and it was 63%. The OD retentate diluted 1:1000000 caused inhibition by 22.2%. The dilution 1:100000 gave a more pronounced effect (32.7%), but the highest effect of inhibition was obtained with the diluted sample 1:50000 and it was 51.6%.

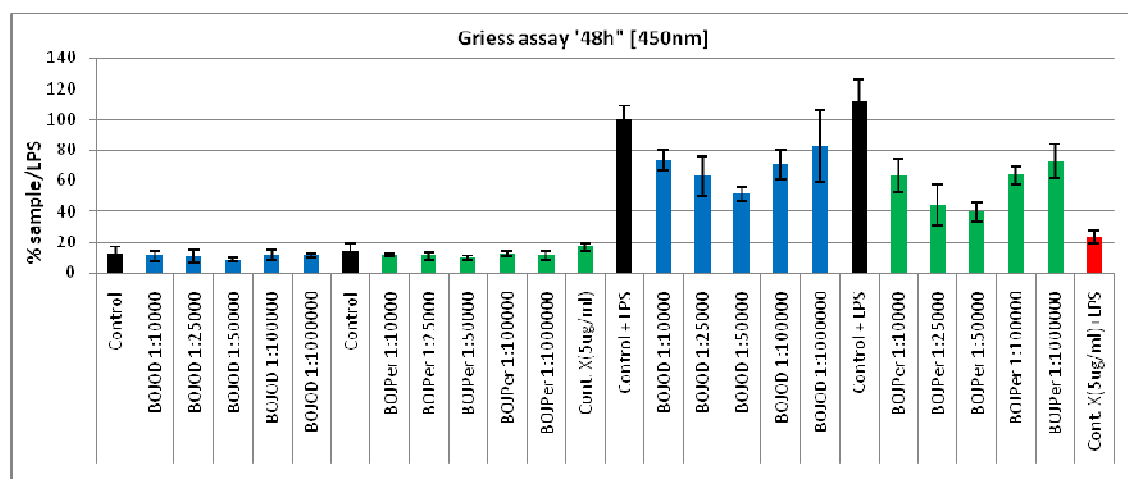

Control= (RAW 264,7 with DMEM), BOJOD=blood orange juice osmotic distillation, BOJPer = blood orange juice Permeate, LPS= lipopolisaccaride and X= Xanthohumul extract.

Figure 5.3.1-1 Inhibitory effect of blood orange juice samples (UF permeate and OD retentate) for NO production in LPS-activated RAW 264.7 mouse macrophages.

### 5.3.2 Effect of UF and OD samples on TNF- $\alpha$ released in LPS-stimulated RAW 264.7 mouse macrophages

The effect of blood orange juice, exactly the samples coming from UF process (permeate) and OD process (retentate) on RAW 264.7 cells stimulated with 1 $\mu$ g/mL of LPS was investigated. Macrophages were treated with different dilutions of blood orange juice in DMEM (1:10, 1:100, 1:1000, 1:10000, 1:25000, 1:50000, 1:100000 and 1:1000000). After 4 h of incubation, the concentrations of TNF- $\alpha$  were measured by ELISA. As shown in Figure 5.3.2-1, the blood orange juice appeared to be an effective inhibitor of TNF- $\alpha$  release. Dilutions 1:10000 and 1:1000 of the UF permeate caused a significant inhibition (about 17%). The dilution 1:100 gave a more pronounced effect (52%). The highest effect of inhibition was observed with the dilution 1:10 and it was 85%. OD retentate samples diluted 1:10000 and 1:1000 caused inhibition of 10%. The dilution 1:100 gave a more pronounced effect (36%), but the highest effect of inhibition was observed with a dilution 1:10 (72%).

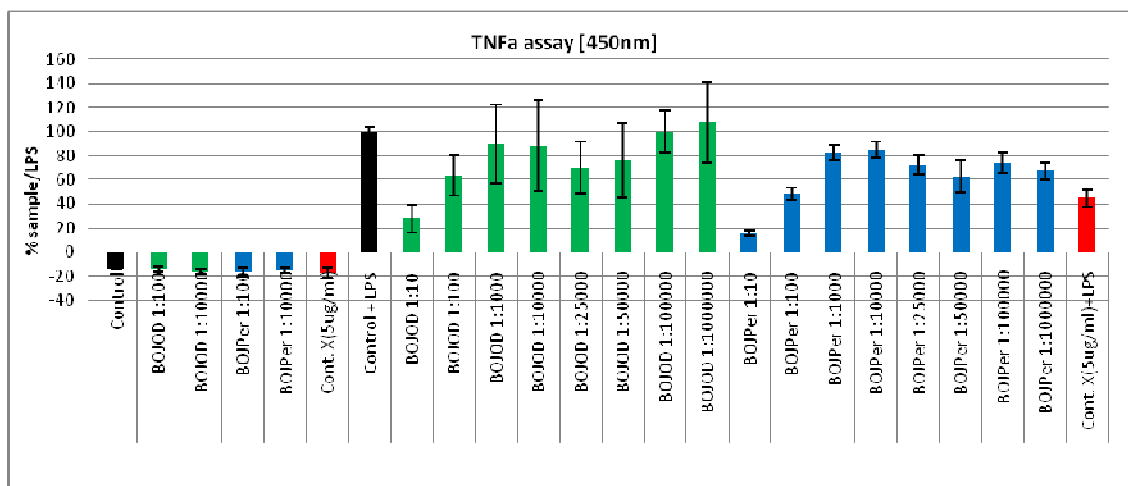

Control= (RAW 264,7 with DMEM), BOJOD=blood orange juice osmotic distillation, BOJPer = blood orange juice Permeate, LPS= lipopolisaccaride and X= Xanthohumol extract.

Figure 5.3.2-1 Inhibitory effect of blood orange juice samples (UF permeate and OD retentate) on the production of pro-inflammatory cytokine of TNF- $\alpha$  in LPS-activated RAW 264.7 mouse macrophages.

### 5.3.3 Effect of UF and OD samples on MCP-1 and IL-6 released in LPS-stimulated RAW 264.7 mouse macrophages

Experiments for MCP-1 and IL-6 were also performed by ELISA by using the corresponding kit. Experiments show that UF permeate and OD retentate had no significant effect in reducing the amount of MCP-1 and IL-6 released in LPS-stimulated RAW 264.7 mouse macrophages. Results are shown in Figure 5.3.3-1.

### 5.3.4 Effect of UF and OD samples on the viability and cytotoxicity in RAW 264.7 mouse macrophages

Cell viability was verified using an XTT cell proliferation kit assay II. In the XTT test the tetrazolium salt is cleaved to formazan by a complex cellular mechanism. The bioreduction occurs in viable cells only, and is primarily related to glycolytic NAD(P)H production. Therefore, the amount of formazan dye formed directly correlates to the number of metabolically active cells in the culture. Neither LPS alone nor LPS in combination with the highest concentration (1:10) of clarified and concentrated samples affected the viability of cells after 24 h (Figures 5.3.4-1 a and b). The viability test showed that the viability of the RAW 264.7 cells was not affected by UF permeate and OD retentate samples (conditions are regarded toxic if cell viability lowers more than

20%). As all the tested compounds were within the viability range of 80-100%, experimental conditions were considered non-toxic.

(a)

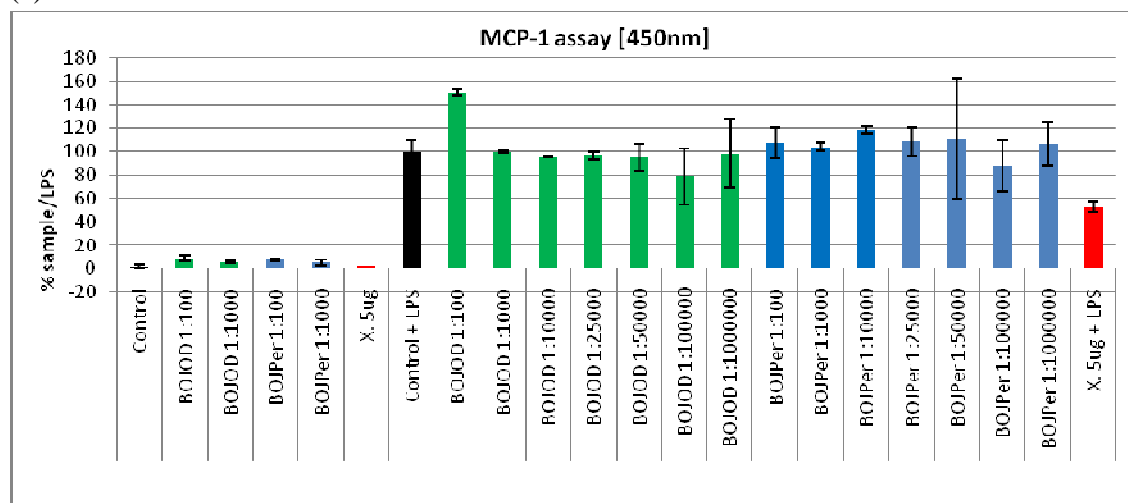

(b)

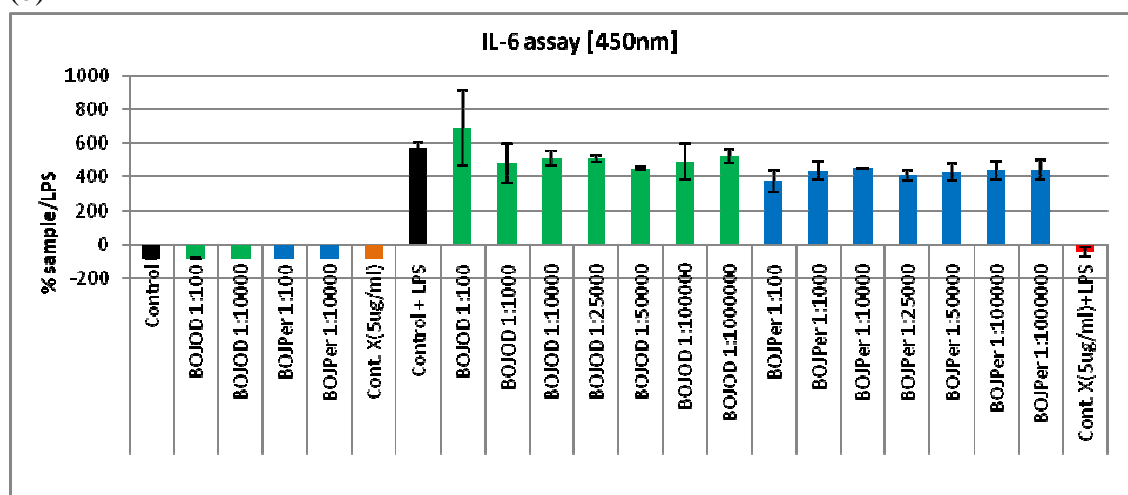

Control= (RAW 264.7 with DMEM), BOJOD=blood orange juice osmotic distillation, BOJPer = blood orange juice Permeate, LPS= lipopolisaccaride and X= Xanthohumul extract.

Figure 5.3.3-1 Inhibitory effect of blood orange juice samples (UF permeate and OD retentate) on the production of pro-inflammatory cytokine: (a) MCP-1 cytokine and (b) IL-6 cytokine in LPS-activated RAW 264.7 mouse macrophages.

(a)

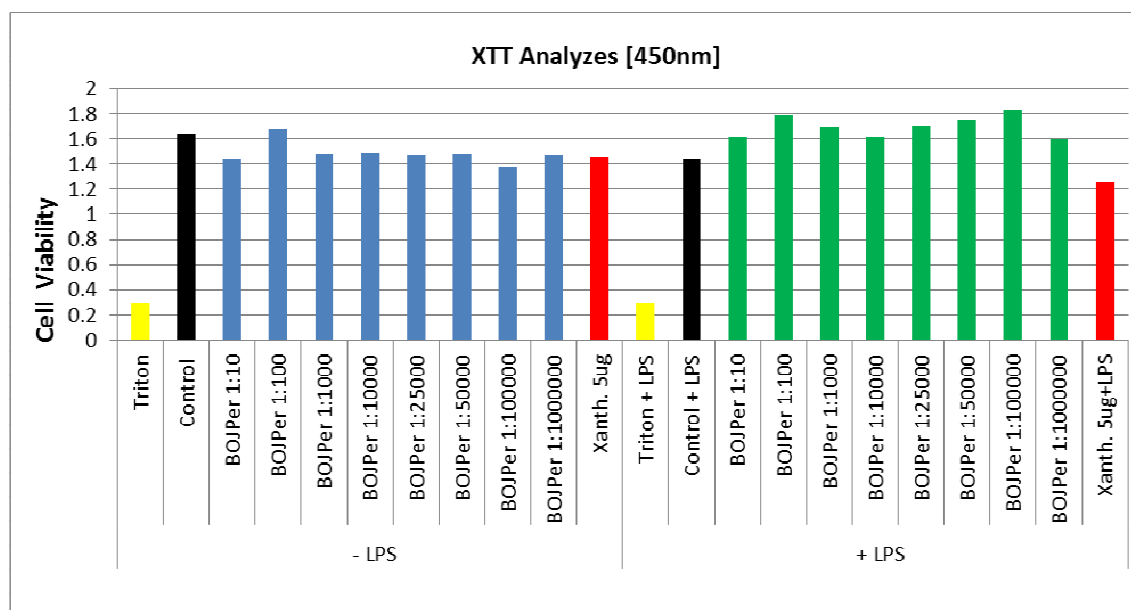

(b)

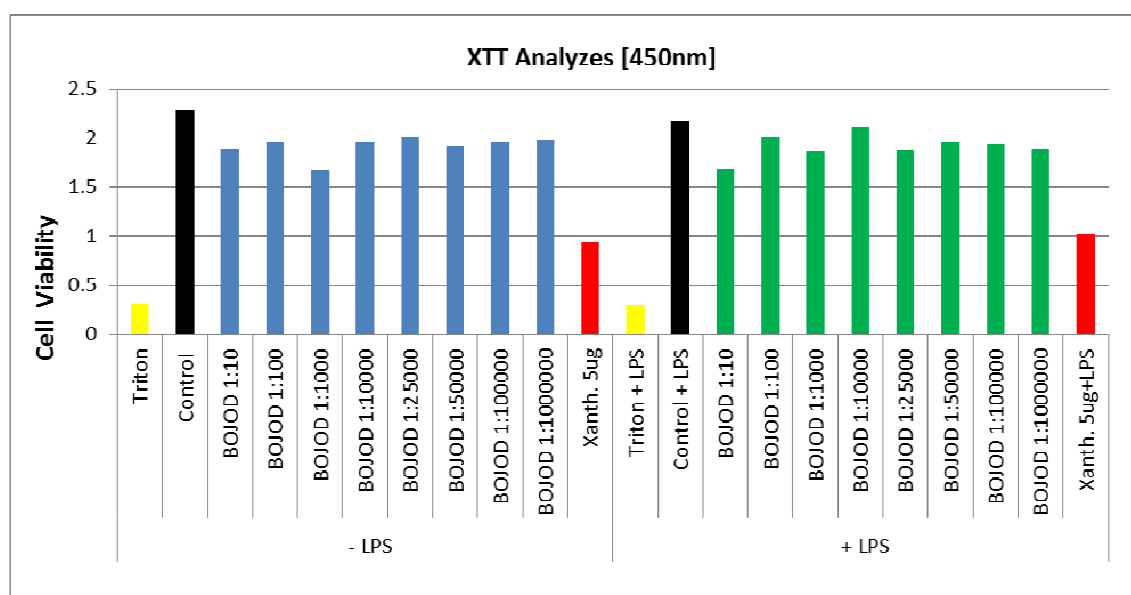

Control= (RAW 264.7 with DMEM), BOJOD=blood orange juice osmotic distillation, BOJPer = blood orange juice Permeate, LPS= lipopolisaccharide and X= Xanthohumul extract.

Figure 5.3.4-1 Viability test of the RAW 264.7 cells with (a) clarified blood orange juice (UF permeate) and (b) concentrated blood orange juice (OD retentate).

In conclusion, according to the obtained results, the treatment of blood orange juice by membrane operations determines an improvement of anti-inflammatory activities of the juice reducing the level of different inflammatory markers as NO and TNF- $\alpha$ .

These results confirm the high potential of membrane operations in preserving bioactive compounds of the citrus juice. The promising results related to the inhibitory activity of UF and OD samples on the production of nitric oxide (NO) and TNF- $\alpha$ , offer interesting perspectives in the formulation of new pharmaceutical products starting from natural sources. Further investigations could be addressed to the evaluation of the effect of membrane-based processed juices on other anti-inflammatory markers together with their antiviral, anticancer and vasodilatory action.

**References**

1. Rapisarda, P. (1997) *Evoluzione e sviluppo nella produzione di succhi di arancia in Italia*. Rivista di Frutticoltura e Arbofloricoltura, 12, 23-25.
2. Stavric, B. (1994) *Antimutagens and anticarcinogens in foods*. Food and Chemical Toxicology, 32(1), 79-90.
3. Benavente-Garcia, O., Castillo, J. (2008) *Update on uses and properties of citrus flavonoids: new findings in anticancer, cardiovascular, and anti-inflammatory activity*. Journal of Agricultural and Food Chemistry, 56(15), 6185-205.
4. Harborne, J.B., Williams, C.A. (2000) *Advances in flavonoid research since 1992*. Phytochemistry, 55(6), 481-504.
5. Schijlen, E.G., Ric de Vos, C.H., van Tunen, A.J., Bovy, A.G. (2004) *Modification of flavonoid biosynthesis in crop plants*. Phytochemistry, 65(19), 2631-2648.
6. Lyseng-Williamson, K.A., Perry, C.M. (2003) *Micronised purified flavonoid fraction: a review of its use in chronic venous insufficiency, venous ulcers and haemorrhoids*. Drugs, 63(1), 71-100.
7. Maccarone, E., Maccarone, A., Perrini, G., Rapisarda, P. (1983) *Anthocyanins of the Moro orange juice*. Analytical Chemistry, 73, 533-539.
8. Maccarone, E., Rapisarda, P., Fanella, F., Arena, E., Mondello, L. (1998) *Cyanidin-3-(6"-malonyl)-glucoside. An important anthocyanin of blood orange juice*. Italian Journal of Food Science, 10, 367-372.
9. Álvarez, R., Carvalho, C.P., Sierra, J., Lara, O., Cardona, D., Londono-Londono, J. (2011) *Citrus Juice Extraction Systems: Effect on Chemical Composition and Antioxidant Activity of Clementine Juice*. Journal of Agricultural and Food Chemistry, 60(3), 774-781.
10. Maccarone, E., Campisi, S., Cataldi Lupo, M.C., Fallico, B., Nicolosi Asmundo, C. (1996) *Thermal treatments effects on the red orange juice constituents*. Industria Bevande, 25, 335-341.
11. Rapisarda, P., Tomaino, A., Lo Cascio, R., Bonina, F., De Pasquale, A., Saija, A. (1999) *Antioxidant effectiveness as influenced by phenolic content of fresh orange juices*. Journal of Agricultural and Food Chemistry, 47(11), 4718-4723.
12. Dussossoy, E., Brat, P., Bony, E., Boudard, F., Poucheret, P., Mertz, C., Giaimis, J., Michel, A. (2011) *Characterization, anti-oxidative and anti-inflammatory effects of Costa Rican noni juice (Morinda citrifolia L.)*. Journal of Ethnopharmacology, 133(1), 108-115.

13. Hotamisligil, G.S. (2006) *Inflammation and metabolic disorders*. Nature, 444(7121), 860-867.
14. Sartipy, P., Loskutoff, D.J. (2003) *Monocyte chemoattractant protein 1 in obesity and insulin resistance*. Proceedings of the National Academy of Sciences USA, 100(12), 7265-7270.
15. Carswell, E.A., Old, L.J., Kassel, R.L., Green, S., Fiore, N., Williamson, B. (1975) *An endotoxin-induced serum factor that causes necrosis of tumors*. Proceedings of the National Academy of Sciences USA, 72(9), 3666-3670.
16. Mayer, B., Hemmens, B. (1997) *Biosynthesis and action of nitric oxide in mammalian cells*. Trends in Biochemical Science, 22(12), 477-481.
17. Palmer, R.M., Ferrige, A.G., Moncada, S. (1987) *Nitric oxide release accounts for the biological activity of endothelium-derived relaxing factor*. Nature, 327(6122), 524-526.
18. Farrell, A.J., Blake, D.R. (1996) *Nitric oxide*. Annals of the Rheumatic Diseases, 55(1), 7-20.
19. Gil, A. (2002) *Polyunsaturated fatty acids and inflammatory diseases*. Biomedicine and Pharmacotherapy, 56(8), 388-396.
20. Rice-Evans, C., Miller, N.J. (1994) *Total antioxidant status in plasma and body fluids*. Methods in Enzymology, 234, 279-93.
21. Green, L.C., Wagner, D.A., Glogowski, J., Skipper, P.L., Wishnok, J.S., (1982) *Analysis of nitrate, nitrite, and [15N]nitrate in biological fluids*. Analytical Biochemistry, 126(1), 131-138.
22. Lupinacci, E., Meijerink, J., Vincken, J.P., Gabriele, B., Gruppen, H., Witkamp, R.F. (2009) *Xanthohumol from hop (Humulus lupulus L.) Is an efficient inhibitor of monocyte chemoattractant protein-1 and tumor necrosis factor- $\alpha$  release in LPS-Stimulated RAW 264.7 mouse macrophages and U937 human monocytes*. Journal of Agricultural and Food Chemistry, 57(16), 7274–7281.

# Conclusions

The aim of the experimental activities was to evaluate the potential of an integrated membrane process in the production of formulations of interest for food and pharmaceutical industries starting from the blood orange juice produced in the Calabria region. The blood orange juice, after a depectinization step, was submitted to the clarification procedure based on the use of hollow fiber UF membranes and then concentrated by using OD hollow fiber membranes.

The effect of both processes on permeate and evaporation fluxes, the quality of clarified and concentrated juices (in terms of suspended solids content, total soluble solids, phenolic compounds and total antioxidant activity) and their anti-inflammatory activity was analysed and discussed.

The investigated process, based on the integration of two membrane technologies, ultrafiltration (UF) and osmotic distillation (OD), presented good potential for recovering and concentrating most part of antioxidant compounds of blood orange juices.

The UF process permitted to remove suspended solids from the depectinised orange juice producing a clear juice in which the total antioxidant activity was well preserved in comparison to the fresh juice. Phenolic compounds were recovered in the clarified juice as confirmed by the low rejection values of the UF membrane toward these compounds (between 0.4 and 6.9%).

A total of 11 phenolic compounds were identified in the clarified juice including hydroxycinnamic acids, hydroxybenzoic acids, flavanones and flavan-3-ols. HPLC-ESI-MS<sup>n</sup> analyses revealed also the presence of three anthocyanins in the clarified juice.

The concentration of the UF permeate by OD produced a concentrated juice with a total soluble solids content of 61.4°Brix. A direct comparison of results between clarified and concentrated juice showed no significant differences in their content of phenolic compounds. Consequently a good preservation of antioxidant compounds was guaranteed by the integrated UF-OD process in which thermal and mechanical stress of the juice is strongly reduced in comparison with conventional methodologies.



The treatment of blood orange juice by membrane operations determines also an improvement of anti-inflammatory activities of the juice reducing the level of different inflammatory markers as NO and TNF- $\alpha$ .

The promising results related to the inhibitory activity of UF and OD samples on the production of nitric oxide (NO) and TNF- $\alpha$ , offer interesting perspectives in the formulation of new pharmaceutical products starting from natural sources. Further investigations could be addressed to the evaluation of the effect of membrane-based processed juices on other anti-inflammatory markers together with their antiviral, anticancer and vasodilatory action.

## **Ringraziamenti / Thanks**

Rivolgo un doveroso ringraziamento alla mia famiglia per il loro sostegno morale e affettivo.

Intendo ringraziare tutti gli amici che durante questi anni mi sono stati vicini e mi hanno sostenuto moralmente.

Voglio ringraziare inoltre i amici che mi hanno aiutato nel mio lavoro di tesi come Vito, Pierluigi, Mieke, Alessia, Aamer, Renè, ecc.

Ringrazio i professori : Prof. Bartolo, Prof. Salerno, Prof. Renger, Prof. Jocelijn, per il loro sostegno e contributo.

Un sincero e doveroso ringraziamento al Dott. Cassano per la sua disponibilità e gentilezza nei miei confronti.

In fine, ma non per ordine di importanza, un ringraziamento speciale va alla mia *moglie* che mi ha accompagnato durante la mia carriera universitaria sostenendomi moralmente e affettivamente in ogni momento dandomi forza e coraggio nel andare avanti.

*Fitim Destani*